

ARTEMIS: Gianna 3"

Architectural Recessed Down Light (Duet)

Gianna 3" Downlights come in adjustable, fixed, adjustable snout, adjustable tube, adjustable extended tube, and twin format. They also come in squared-shaped frames, known as the Gianna Solo, Duet, and Quartet format. With the magnetic fixing structure, the modules are easily installed and maintained.

FEATURES

- Cold-forged aluminum radiator, twice heat dissipation of the die-cast aluminum
- COB LED Chip, deep hidden light source, multiple anti-glare
- Aluminum Reflector, Much better lighting distribution than plastic
- Fully metal made, good texture, high performance
- Comes in trim & trimless and semi-recessed

Client:	
Order#:	
Project:	
Type:	



PERFORMANCE DATA

Product ID	Body	Light Direction	Appearance	Wattage	Beam Angle	CCT	CRI	Driver Voltage
GIANNA-D-F	Duet (Square)	Fixed (IP44)	Trim & Trimless	Max: 2 x 15W	15° 25° 35° 50°	2700K 3000K 4000K	90Ra	AC 100-120V
GIANNA-D-A		Adjustable (IP20)						

ORDERING INFORMATION

GIANNA / DUET / _____ / _____ / _____ / _____ / _____ / _____
SERIES BODY LIGHT DIRECTION APPEARANCE REFLECTOR COLOR CCT BEAM ANGLE WARRANTY

FIXTURE SERIES	
GIANNA	Gianna 3" Recessed Deco Downlight
BODY	
D	Duet (Square)
LIGHT DIRECTION	
F	Fixed (IP44)
A	Adjustable (IP20): 360° Horizontal, 25° Vertical
APPEARANCE	
T	Trim
TL	Trimless

REFLECTOR COLOR	
W	White
B	Black
G	Gold
CCT	
27K	2700K
30K	3000K
40K	4000K
BEAM ANGLE	
15	15°
25	25°
35	35°
50	50°
WARRANTY	
5	5 Year Warranty (included)
10	10 Year Warranty

GIANNA-D-F-T Fixed / Trim

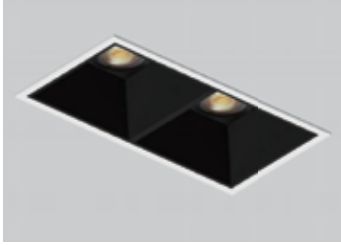

P. system	I (led)	Beam Angle	CCT	Lumens
2*15W	2*350mA	15°	2700K	1524.0lm
			3000K	1629.0lm
			4000K	1850.0lm
2*15W	2*350mA	25°	2700K	1990.5lm
			3000K	2095.5lm
			4000K	2316.5lm
2*15W	2*350mA	35°	2700K	2178.6lm
			3000K	2283.6lm
			4000K	2504.6lm
2*15W	2*350mA	50°	2700K	2363.4lm
			3000K	2468.4lm
			4000K	2689.4lm



Light Source	Input Voltage	CRI	UGR	Shielding Angle
LED COB	DC36V	90Ra	☒ 16	35°

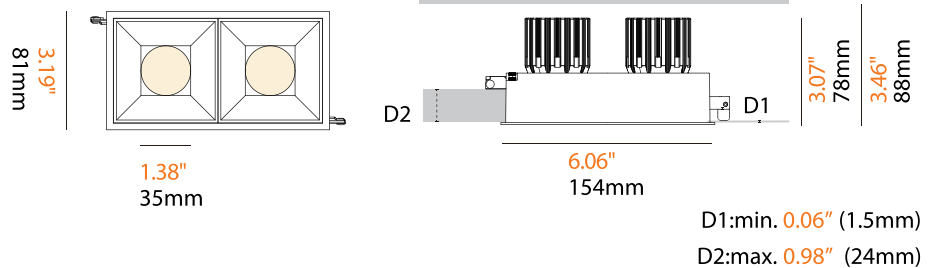
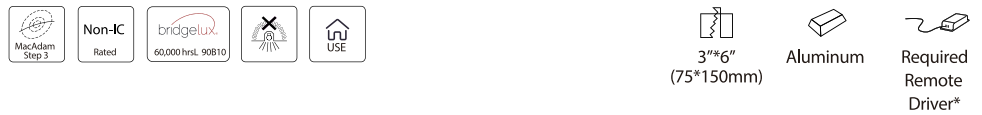

With Trim

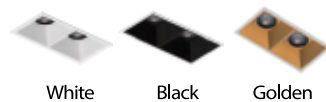

Driver: 120-277Vac ON-OFF | TRIAC | 0/1-10V | DALI

GIANNA-D-F-TL Fixed / Trimless

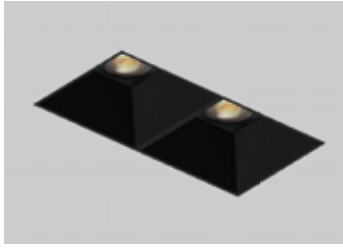

P. system	I (led)	Beam Angle	CCT	Lumens
2*15W	2*350mA	15°	2700K	1524.0lm
			3000K	1629.0lm
			4000K	1850.0lm
2*15W	2*350mA	25°	2700K	1990.5lm
			3000K	2095.5lm
			4000K	2316.5lm
2*15W	2*350mA	35°	2700K	2178.6lm
			3000K	2283.6lm
			4000K	2504.6lm
2*15W	2*350mA	50°	2700K	2363.4lm
			3000K	2468.4lm
			4000K	2689.4lm



Light Source	Input Voltage	CRI	UGR	Shielding Angle
LED COB	DC36V	90Ra	☒ 16	35°

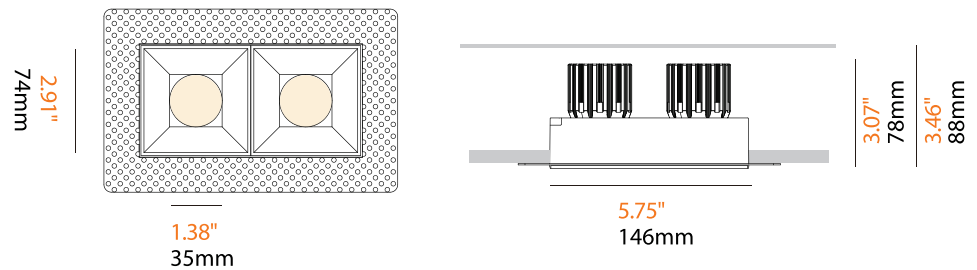

Trimless



Driver: 120-277Vac ON-OFF | TRIAC | 0/1-10V | DALI

GIANNA-D-A-T Adjustable / Trim

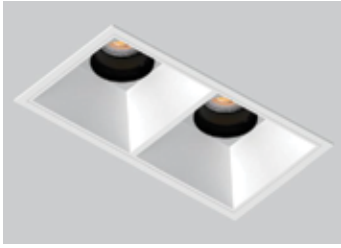

P. system	I (led)	Beam Angle	CCT	Lumens
2*15W	2*350mA	15°	2700K	1524.0lm
			3000K	1629.0lm
			4000K	1850.0lm
2*15W	2*350mA	25°	2700K	2290.5lm
			3000K	2395.5lm
			4000K	2616.5lm
2*15W	2*350mA	35°	2700K	2478.6lm
			3000K	2583.6lm
			4000K	2804.6lm
2*15W	2*350mA	50°	2700K	2663.4lm
			3000K	2768.4lm
			4000K	2989.4lm



Light Source	Input Voltage	CRI	UGR	Shielding Angle
LED COB	DC36V	90Ra	☒ 13	50°

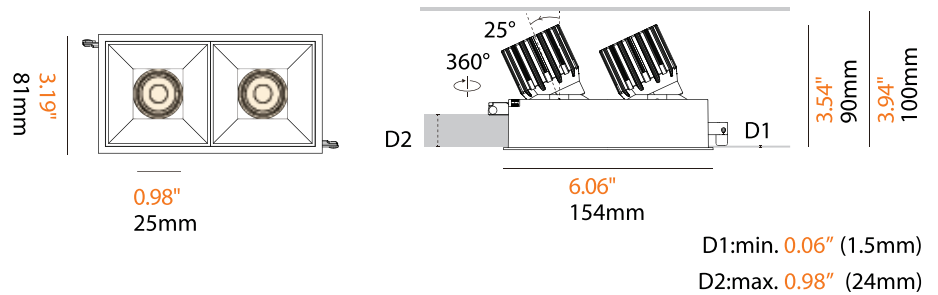

With Trim



Driver: 120-277Vac ON-OFF | TRIAC | 0/1-10V | DALI

GIANNA-D-A-TL Adjustable / Trimless

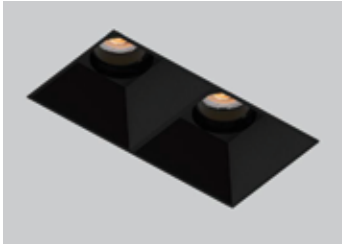

P. system	I (led)	Beam Angle	CCT	Lumens
2*15W	2*350mA	15°	2700K	1524.0lm
			3000K	1629.0lm
			4000K	1850.0lm
2*15W	2*350mA	25°	2700K	2290.5lm
			3000K	2395.5lm
			4000K	2616.5lm
2*15W	2*350mA	35°	2700K	2478.6lm
			3000K	2583.6lm
			4000K	2804.6lm
2*15W	2*350mA	50°	2700K	2663.4lm
			3000K	2768.4lm
			4000K	2989.4lm



Light Source	Input Voltage	CRI	UGR	Shielding Angle
LED COB	DC36V	90Ra	☒ 13	50°

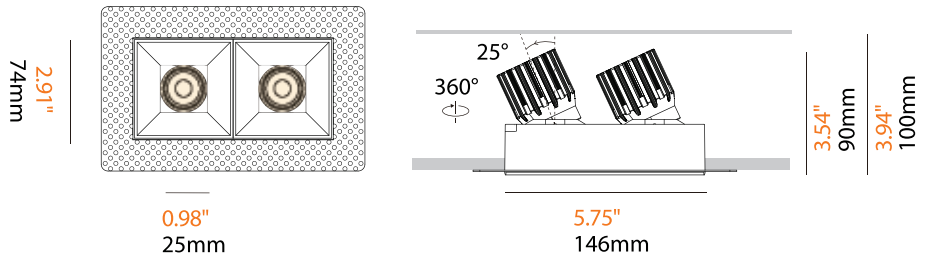

Trimless



Driver: 120-277Vac ON-OFF | TRIAC | 0/1-10V | DALI

Accessories

Drivers in Junction Box

CMEM55-XX
 TRIAC 6W, 8W, 10W, 15W
 XX = *Must specify wattage*

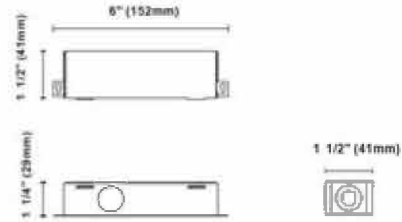

KIG-020-WDJ
 Triac/0-10V/1-10V LED DRIVER 10w/15w/17w/18w/20w 120-277V
 [250mA, 350mA, 400mA, 450mA, 500mA, 600mA, 700mA]

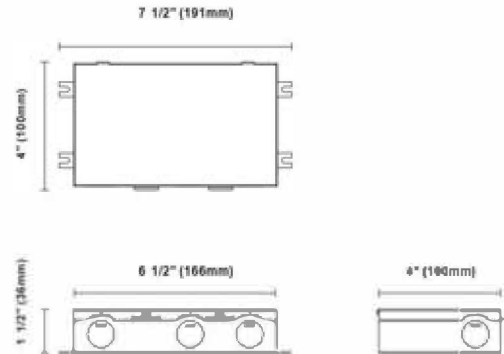

Brackets for New-Construction

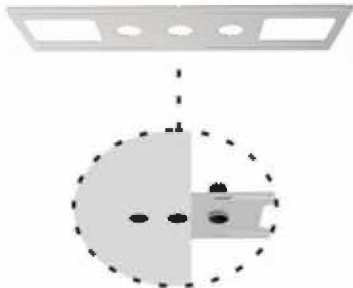

BRKT-3R45A

For Artemis trim & trimless
 Type: New construction plate

Cut out:

Round: Ø1" * 3(Ø50mm)

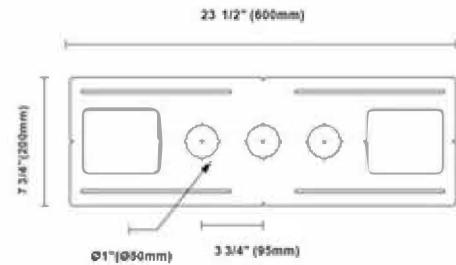

Remark

- Tailored brackets are available with a reasonable surcharge, details as below,
- The customized brackets' dimensions are still the same as the existing ones, 600*200mm
 - Hole sizes can be customized within the range of 25-100mm
 - Holes quantity can be indicated, 1-7pcs
 - Holes' positions on the bracket can be done as requests

Brackets for New-Construction (4-legs)

NCP-SR3-R21-XXX
 xxx = *must specify wattage*



Cut out:
 Round: Ø3" (Ø77mm)
 Ø2" (Ø62mm)
 Ø1" (Ø50mm)
 Square: □3" (□77mm)

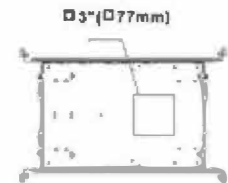
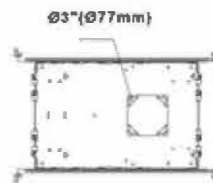
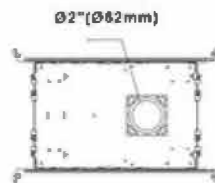
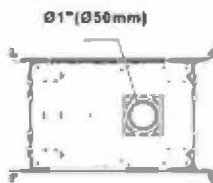
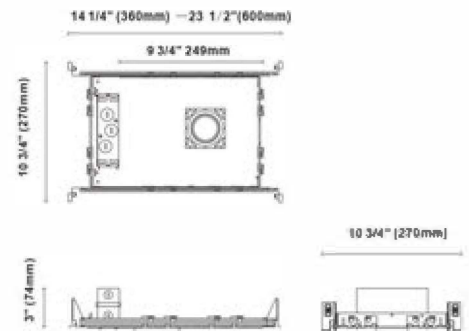

IC-Box for New-Construction (4-legs)

NCBX-SR3-R21-XXX
 xxx = *must specify wattage*



Cut out:
 Round: Ø3" (Ø77mm)
 Ø2" (Ø62mm)
 Ø1" (Ø50mm)
 Square: □3" (□77mm)

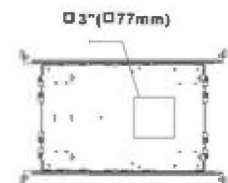
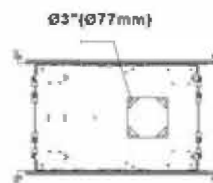
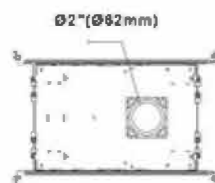
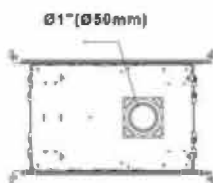
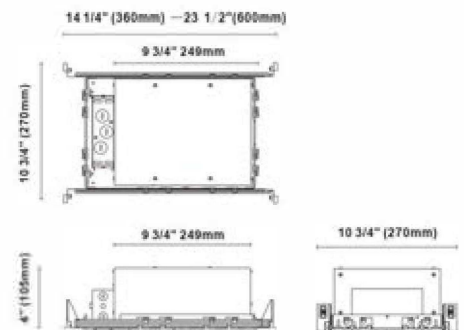

NON-IC Wire Diagram

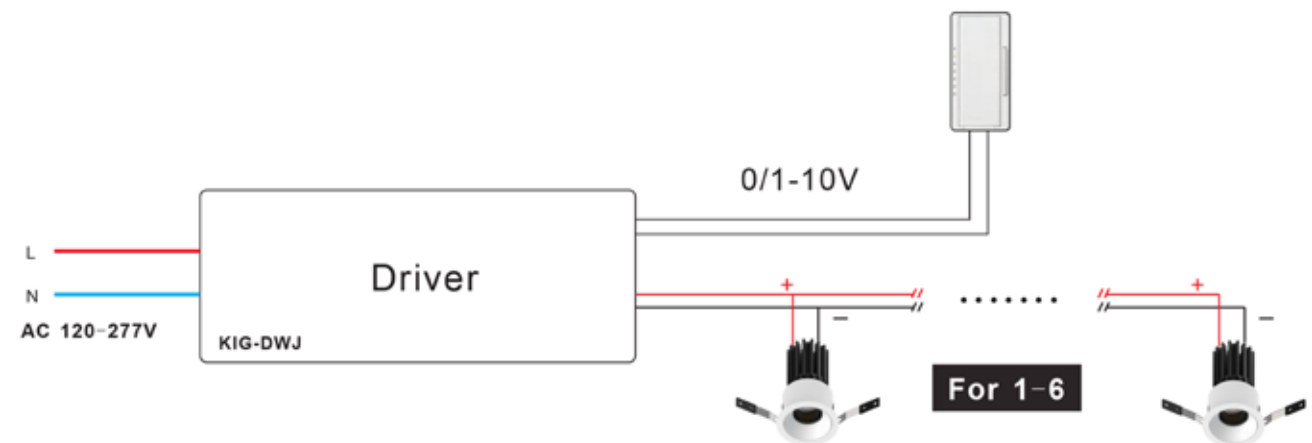
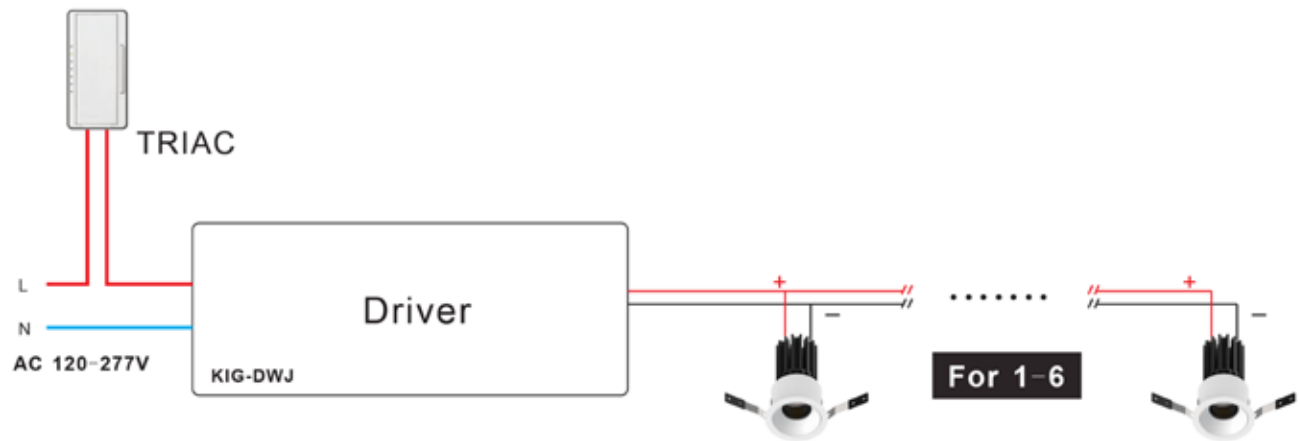
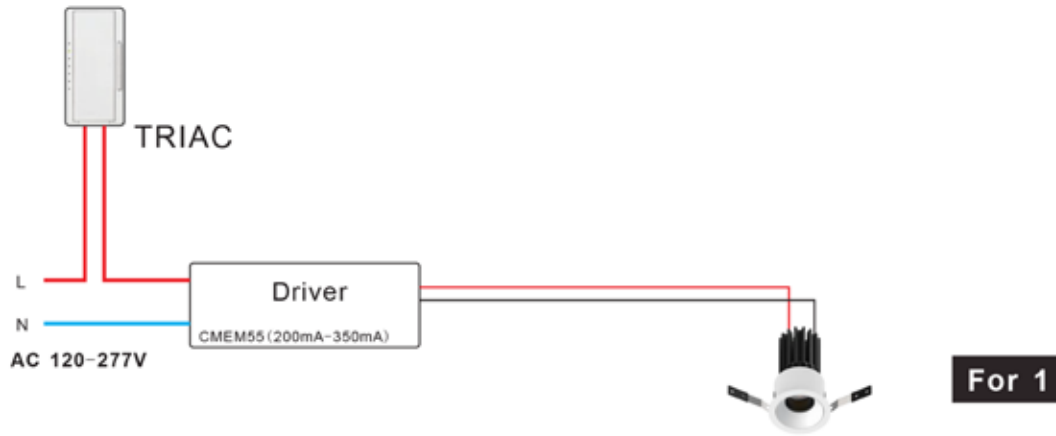

IC Rated Wire Diagram

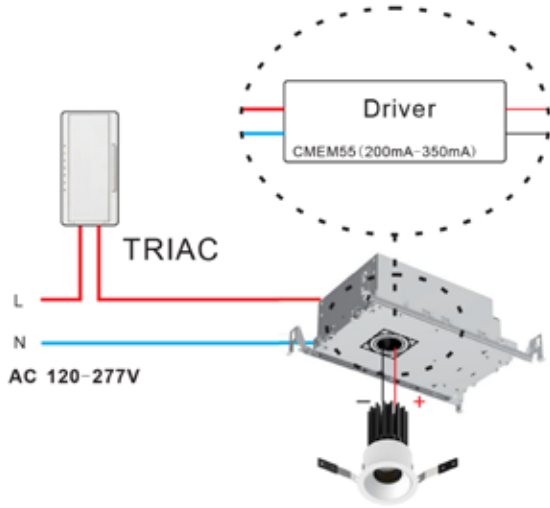

For 1

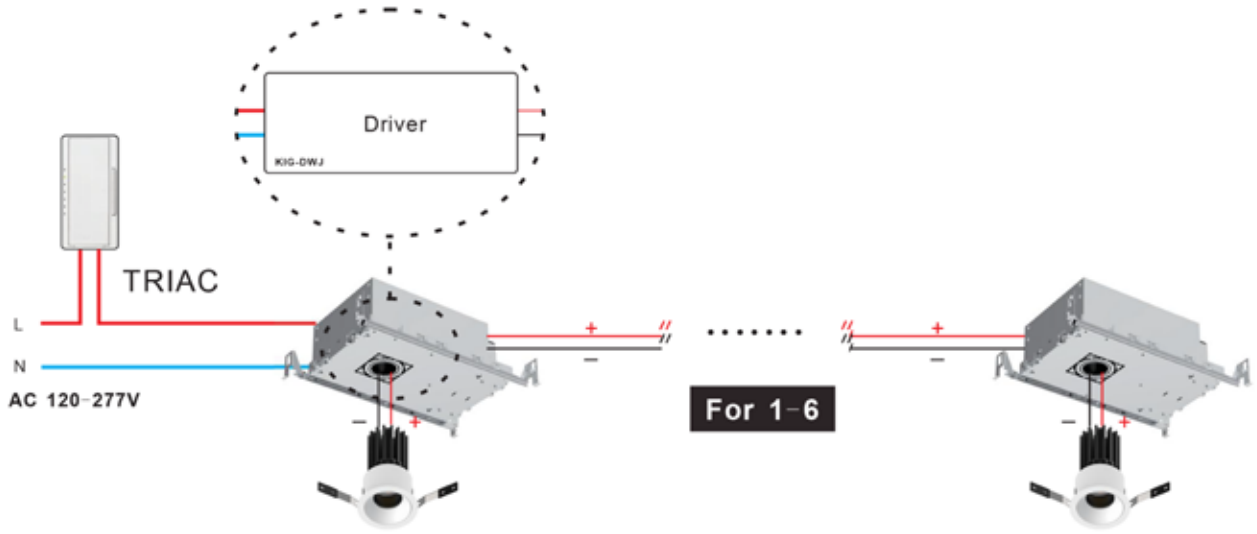

For 1-6

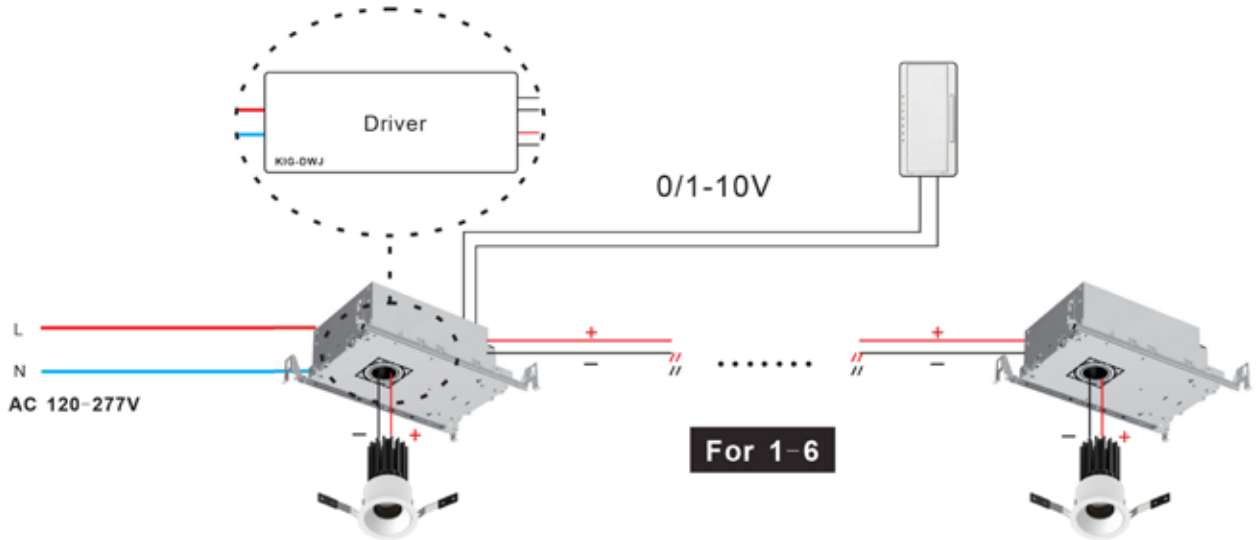

For 1-6