

IMPACT ACOUSTIC®

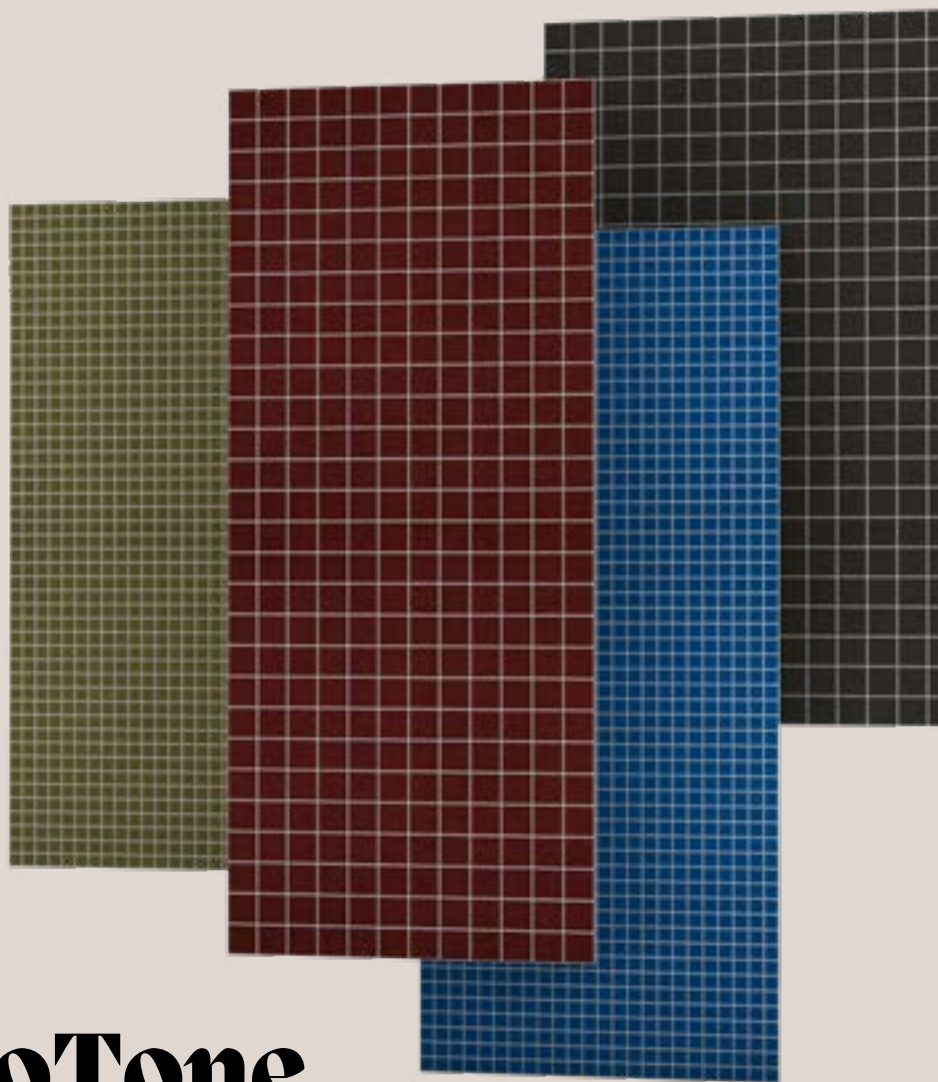

MonoTone

Wall Covering

734.12.11.100.00
734.12.12.100.00
734.24.11.100.00
734.24.12.100.00

TECHNICAL DATA SHEET

MonoTone Wall Covering

General Information



Data

Applicable article numbers

12mm Square 50	734.12.11.000.00
24mm Square 50	734.24.11.000.00
12mm Square 100	734.12.12.000.00
24mm Square 100	734.24.12.000.00

Total Dimensions¹

	24mm / 12 mm	0.9" / 0.5"
--	---------------------	--------------------

Height	2400mm / 2800mm	95" / 110"
Width	1800mm / 1200mm	71" / 47"

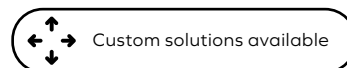

Custom solutions available

Material

Wall Covering	100% PET (60% post-consumer) in 45 colours Printed using UL Greenguard acrylic ink
---------------	---

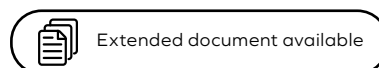

Extended document available

Weight²

24mm / 0.95"	4 kg/m ²	0.82 lbs/sq.ft
12mm / 0.47"	2.4 kg/m ²	0.49 lbs/sq.ft

Included

PET Panels



Installation
guide



Warranty
10 years³



1 - all dimensions are nominal

2 - all weights are nominal

3 - Impact Acoustic warranty terms apply

MonoTone Wall Covering

Specification Guide

Ensure you make the perfect choice by choosing our solutions for your next project. To get started, simply define some basic information and constraints about your space. Then explore our range of standard solutions or contact us directly for a more in-depth discussion of personalised, customized options.

1 Prepare this information:

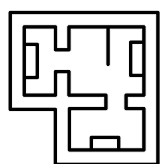

Project Area

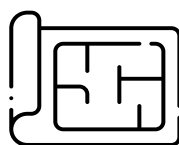

Plans



Other Considerations

2 Specify your Wall Covering:

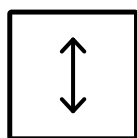

Material Thickness

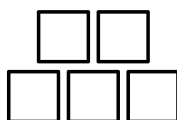

Quantity

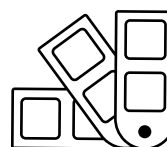

Colour

3 Mount options:

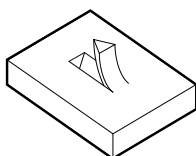

Undercover mount¹

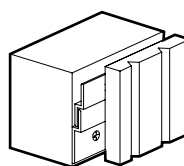

Z-Clip profiles

4 Article numbers:

734	Material Thickness ²	12	Colour	Mount type
734	24mm	12	Choose colour	00
	12mm			

Example: 734.24.12.662.00

Wall Covering - Monotone, 2400 x 1800 x 24mm, 662 - Poster Red, 00 - Undercover mount

¹ - Patent Pending No.102024000009088 ² - all dimensions are nominal

MonoTone 50

Geometry Information

MonoTone 50 24mm

Applicable article numbers

734.24.11.000.00 and .10

Scope of delivery

For each 24mm item you will receive a set of 1x PET panels (in the dimensions below)

Installation

These panels are mounted with a concealed attachment system. For other options contact our consultants.

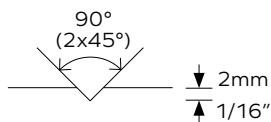

V-cut detail

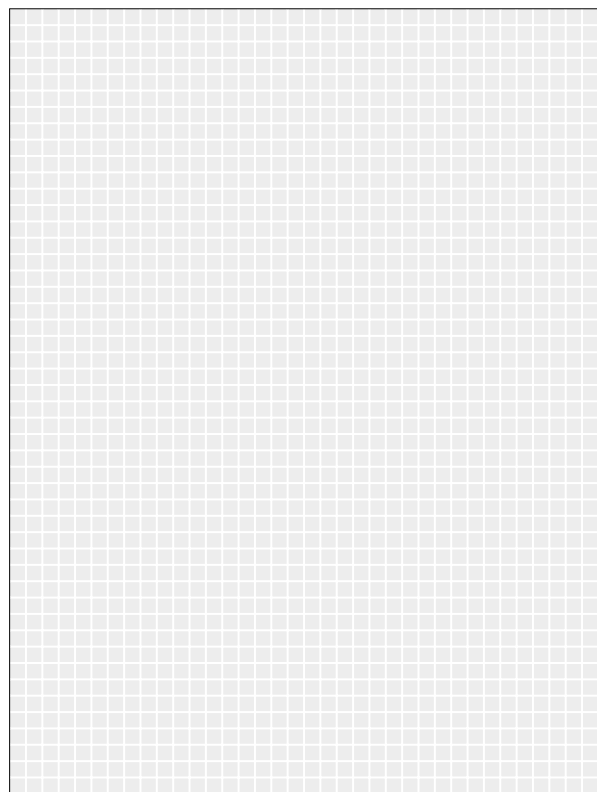
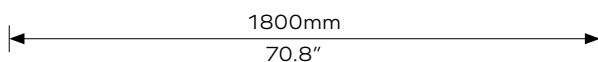

1x

MonoTone 50 12mm

Applicable article numbers

734.12.11.000.00 and .10

Scope of delivery

For each 12mm item you will receive a set of 1x PET panels (in the dimensions below)

Installation

These panels are mounted with a concealed attachment system. For other options contact our consultants.

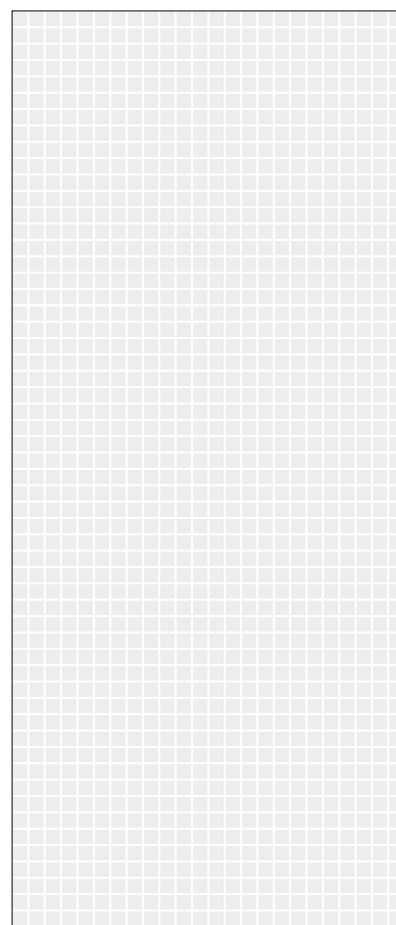
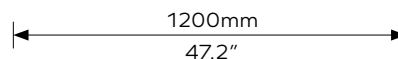

1x

MonoTone 50 Wall Covering

Reference



MonoTone 100

Geometry Information

MonoTone 100 24mm

Applicable article numbers

734.24.12.000.00 and .10

Scope of delivery

For each 24mm item you will receive a set of 1x PET panels (in the dimensions below)

Installation

These panels are mounted with a concealed attachment system. For other options contact our consultants.

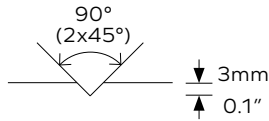

V-cut detail

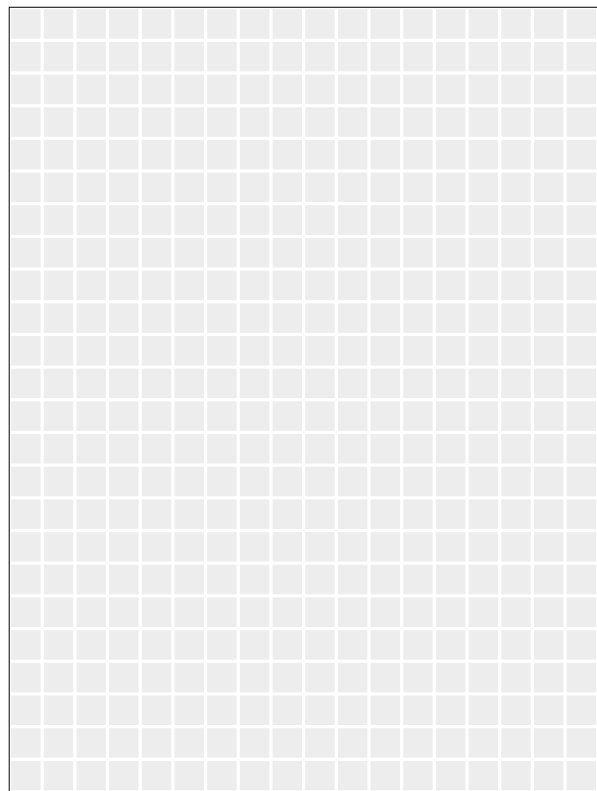
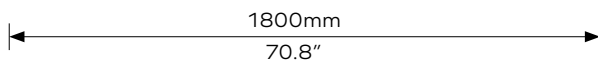

1x

MonoTone 100 12mm

Applicable article numbers

734.12.12.000.00 and .10

Scope of delivery

For each 12mm item you will receive a set of 1x PET panels (in the dimensions below)

Installation

These panels are mounted with a concealed attachment system. For other options contact our consultants.

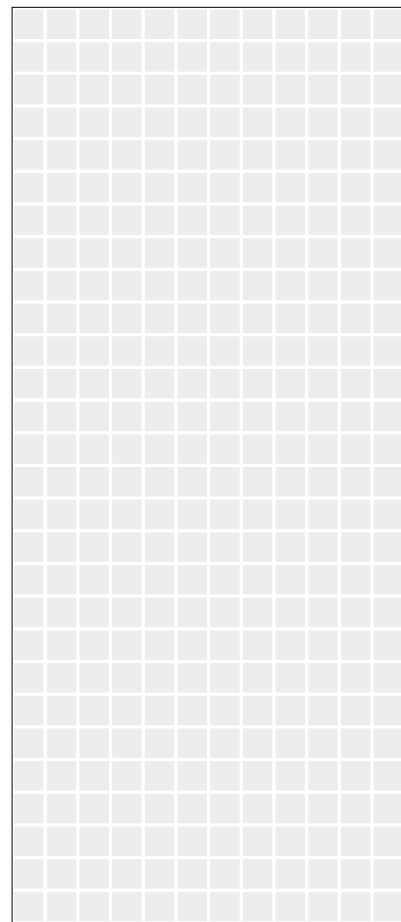
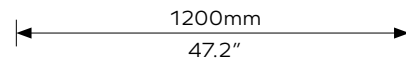

2800mm
110.2"

2400mm
94.4"

1x

MonoTone 100 Wall Covering

Reference



MonoTone Wall Covering

Installation methods overview

Undercover Mount (standard) *Patent Pending¹*

All our Wall Covering products come with pre-cut **Undercover** attachment points. Those points are distributed along the edge (10-15mm offset) of the panel. **Undercover** mounting system allows for concealed mechanical attachment of the panel to the mounting surface. The **installation hardware** (screws, bolts) needs to be selected in accordance to the surface on which panels are applied, and are **not included**.

1 Locate the Undercover cuts on the panel

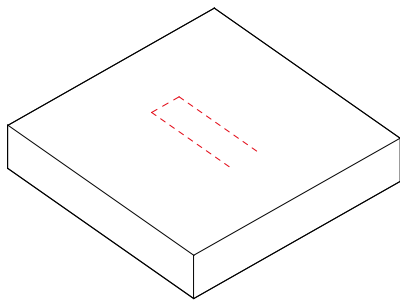

2 Pull out the edge

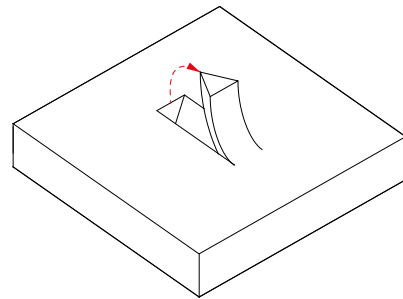

3 Install hardware

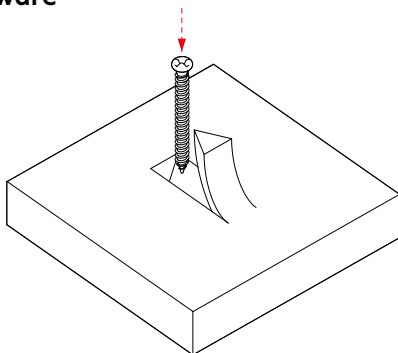

4 Close

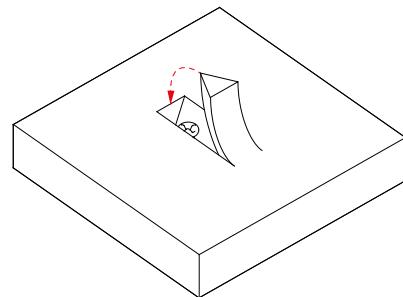

¹ - Patent Pending No.102024000009088

MonoTone Wall Covering

Installation methods overview

1 On-Site adjustments.



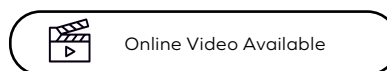
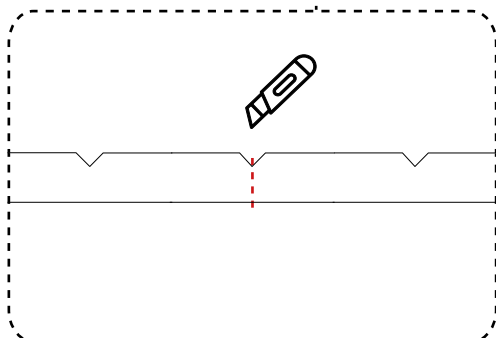
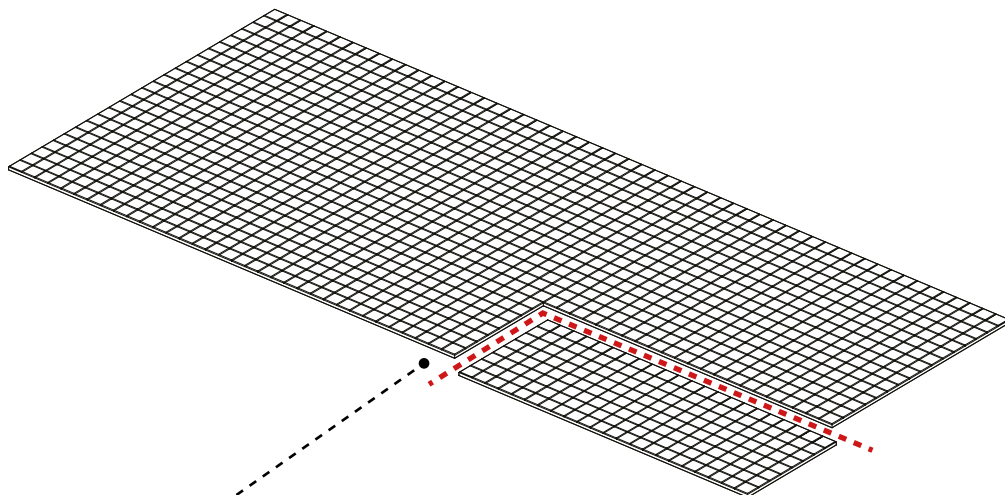
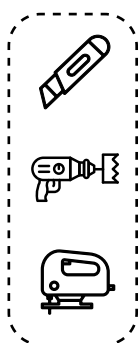









































MonoTone panel can be adjusted on site using standard tools like a utility knife, a crown drill (hole saw) or a circular saw. We recommend cutting along the v-cut groves for the best results.



ARCHISONIC®

Colours

 Material brochure available

									
Name	Snow White	Cloud	Smoke	Slate	Charcoal	Raven	Ground	Gull	Milk
Code	500	103	442	444	542	550	108	144	404
NCS	S 0300-N	S 1002-B	S 3005-R80B	S 4500-N	S 7502-B	S 8500-N	S 5005-Y20R	S 2502-Y	S 0502-Y
									
Name	Linen	Dune	Jute	Fallow	Warm Stone	Truffle	Sunshine	Honeycomb	Electric Orange
Code	107	104	920	238	105	539	846	139	464
NCS	S 1505-Y30R	S 2005-Y	S 3010-Y30R	S 5010-Y30R	S 3010-Y50R	S 8502-R	S 1040-Y10R	S 2050-Y20R	S 0580-Y70R
									
Name	Terracotta	Soft Coral	Cinnabar	Shell Pink	Garnet	Poster Red	Hot Pink	Grape	Marine Blue
Code	239	516	725	102	724	662	140	540	864
NCS	S 4040-Y70R	S 2020-Y90R	S 6030-R	S 0510-R30B	S 5040-R10B	S 1080-R	S 2060-R20B	S 5040-R40B	S 4050-R70B
									
Name	Midnight	Royal Blue	Winter Sky	Deep Sea	Nocturne	True Navy	Ice Blue	Pacific Ocean	Lagoon
Code	810	865	410	918	866	194	304	432	917
NCS	S 7020-R70B	S 3560-R80B	S 2020-R90B	S 5020-R90B	S 8010-R90B	S 8005-B	S 0510-B	S 3040-B	S 7020-B30G
									
Name	Succulent	Spearmint	Seafoam	Nordic Pine	Moss	Grove	Pistachio	Lichen	Fern
Code	712	706	710	311	439	317	315	160	180
NCS	S 3020-B30G	S 1010-B90G	S 3010-G30Y	S 5030-G10Y	S 2040-G40Y	S 7020-G30Y	S 5020-Y	S 4005-Y	S 6010-G90Y

These NCS codes are the closest visual match available and may not be exact to blended fibres.

Colours

ARCHISONIC®

Experience our ARCHISONIC® Felt material with a stunning selection of 45 colours across 9 distinct families, thoughtfully curated by *Colour Hive* in London. Effortlessly combine colours harmoniously to suit your preferences. Discover more in our Materials brochure and order your free sample box today.

Colour fastness

Class 6

ISO 105-B02:A1

Order a free sample box



ARCHISONIC® Felt

Material Specification

Product Name	ARCHISONIC® Felt	
Content	100% PET (60% certified post-consumer content)	
Thickness¹	12mm (0.47")	24mm (0.94")
Max. Size	1200x2800mm (47"x110")	1800x2400mm (70"x94")
Acoustic²	ASTM: NRC=0.6 ISO: α_w =0.65	ASTM: NRC=0.9 ISO: α_w =0.95
Density¹	2400 g/m ² (0.49 lbs/ sqft)	4000 g/m ² (0.82 lbs/sqft)
Colour Fastness	Class 6 ISO 105-B02:A1	
Colour	45 colours (see ARCHISONIC® Felt Colour page for more information)	
Maintenance	For daily cleaning we recommend alcohol solution (75%), e.g. Pantasept. In case of contamination by dust or fluff, use feather duster or a regular vacuum cleaner. For heavy dirt, treat the material with hydrogen peroxide.	
Production Lead time³	21 days	
Fire Rating⁴	DIN EN 13501-1: B-s1, d0	ASTM E84 Class A
VOC Emission	28 Days French Regulation A+ ASTM E84 Pass Breeam® (International, UK, NL, SE, NOR) Exemplary CDPH (CDPH/EHLB/Standard Method V1.2) Pass	
Certifications	Declare label, Cradle to Cradle, UL Environmental Product Declaration, Member of US Green Building Council, Ecobau 1st Priority, Climate-KIC, VOC emissions in LEED EQ credit (low-emitting products), SCS Recycled Content	
Durability	Contract	

1 - all values are nominal 2 - measured with 300mm air cavity 3 - depending on the location and type of product

4 - The following colours carry a B-S2 fire certificate rating: Hot Pink 140 12mm, Lichen 160 12mm, True Navy 194 24mm, Pacific Ocean 432 24mm, Pacific Ocean 432 12mm, Electric Orange 464 24mm, Soft Coral 516 24mm, Raven 550 24mm, Raven 550 12mm, Poster Red 662 12mm, Garnet 724 12mm, Midnight 810 24mm, Marine Blue 864 24mm



Climate-KIC is supported by the EIT, a body of the European Union



Declare.



MonoTone Wall Covering

Acoustic Performance

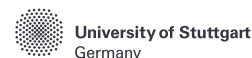

Testing Standards

ISO 354:2003	Acoustics — Measurement of sound absorption in a reverberation room
ISO 11654:1997	Acoustics — Sound absorbers for use in buildings — Rating of sound absorption
ISO 20189:2018	Acoustics — Screens, furniture and single objects intended for interior use — Rating of sound absorption and sound reduction of elements based on laboratory measurements
ASTM C423-17	Standard Test Method for Sound Absorption and Sound Absorption Coefficients by the Reverberation Room Method
ASTM E795-16	Standard Practices for Mounting Test Specimens During Sound Absorption Tests

Acoustic Test Results	aw	SAA	NRC
Archisonic 12mm (no air cavity)	0.3 (MH)	0.42	0.45
Archisonic 12mm (50mm air cavity)	0.5 (MH)	0.70	0.70
Archisonic 12mm (50mm insulation)	1.00	1.00	0.95
Archisonic 24mm (no air cavity)	0.55 (MH)	0.70	0.70
Archisonic 24mm (50mm air cavity)	0.65 (MH)	0.78	0.80
Archisonic 24mm (50mm insulation)	1.00	1.00	1.00

The NRC rating is calculated as the average of the absorption coefficients measured at frequencies of 250Hz, 500Hz, 1000Hz and 2000Hz and round to the nearest 0.05. SAA rating is calculated as the average of the sound absorption coefficients of a material for the twelve one-third octave bands from 200Hz through 2500Hz and rounded off to the nearest 0.01.

Acoustic Performance

Frequency (Hz)		125	250	500	1000	2000	4000
Archisonic 12mm (no air cavity)	α_p	0.05	0.05	0.25	0.55	0.85	1.00
Archisonic 12mm (50mm air cavity)	α_p	0.10	0.30	0.60	0.90	1.00	1.00
Archisonic 12mm (50mm insulation)	α_p	0.35	0.85	1.00	1.00	1.00	1.00
Archisonic 24mm (no air cavity)	α_p	0.05	0.25	0.55	0.90	1.00	1.00
Archisonic 24mm (50mm air cavity)	α_p	0.15	0.35	0.75	1.00	1.00	1.00
Archisonic 24mm (50mm insulation)	α_p	0.40	0.90	1.00	1.00	1.00	1.00

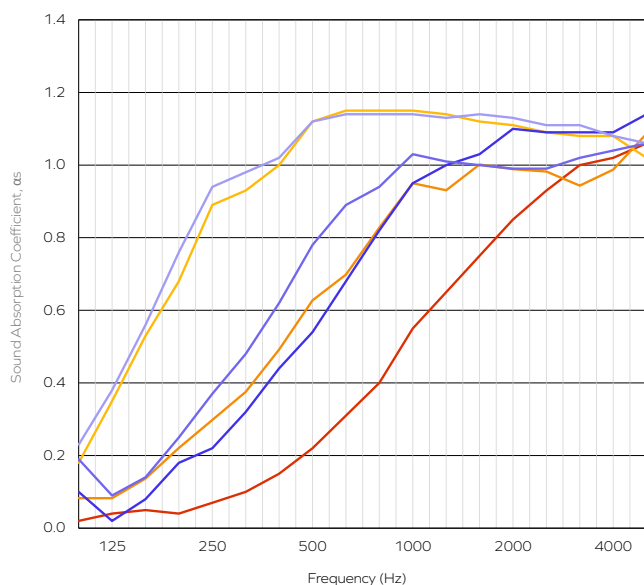

- Archisonic 12mm (no air cavity)
- Archisonic 12mm (50mm air cavity)
- Archisonic 12mm (50mm insulation)
- Archisonic 24mm (no air cavity)
- Archisonic 24mm (50mm air cavity)
- Archisonic 24mm (50mm insulation)

The table represents the practical sound absorption coefficient (α_p) in accordance with ISO 11654. The graph represents the sound absorption coefficients (α_s) in the third octave band center frequencies in accordance with ISO 354. Measurement used Pink Noise as excitation signal in a reverberant room.

MonoTone Wall Covering

Additional Information

Online Resources

A variety of resources are available online for all of our products. Please visit the product's page for more information.



CAD files



Spec sheets and
Installation Guide



Colour families



Instruction
videos



Associated
products specs.

Ordering Process

Our experienced team of Project Consultants will guide and support you throughout the order process. We fulfill the majority of our orders in as little as 21 days¹ from your first point of contact, allowing you to focus on what truly matters to you.



Contact our
consultant

Quote¹

48 h



Order Confirmation

Production¹

2 - 3 Weeks



Dispatch

Transit

location based



Delivery

Contact Us

Ready to make an impact? We are just an email or call away to discuss your project and answer any questions.



+41 41 244 14 00



connect@impactacoustic.com



Online form



¹ - Quote and Production times may vary.

**#We
Make An
Impact**

connect@impactacoustic.com | www.impactacoustic.com