

Product Catalog

2026



Excellent Quality, Tailored Delivery

www.futureonp.com
sales@futureonp.com

● *Professional Manufacturer*

Future Technology is a leading professional prosthetics and orthotics products manufacturer who combines advanced manufacturing technologies with a skilled team of engineers, designers, and medical professionals dedicated to innovation and precision located in China.



● *Product Portfolio*

We offer products with full solutions to our customers with customized service:

- Lower Limb Prostheses for Children
- knee joint & hip joint
- Modular Prosthetic Feet
- Modular Components
- Lock & Liner Systems
- Upper Prostheses
- Accessories
- Raw Materials
- Tools
- Orthotic Components

Moreover, **Customized marking and package** are available to our customers.



● *Quality Assurance*

We are proud to be ISO 13485:2016 certified—the global gold standard for medical device quality management.

This certification reflects our unwavering commitment to delivering prosthetic solutions that are safe, reliable, and fully compliant with the highest industry requirements.

Every product goes through rigorous testing—from material inspections and fatigue resistance trials to biomechanical evaluations—ensuring unmatched durability and patient safety.



Products Overview

LOWER LIMB PROSTHESES FOR CHILDREN...1

3RC10 Single Axis Knee for Children	1
3RC45 Pneumatic Knee for Children	1
3RC60 4-linkage Knee for Children	1
3RC313 Knee Joint for Children	2
7EC10 Hip Joint for Children	2
4RC75 Angled Tube Adapter for Children	2
1EC21 Dynamic Foot for Children	3
1N04 SACH Foot for Children.....	3
1N04B SACH Foot, Toe Split for Children.....	3
4RC67 4-Ear Socket Adapter.....	4
4RC83 Tube Clamp Adapter	4
2RC40 Foot Adapter	4
2RC41 Tube Assembly	4
4RC60 4-Hole Female Adapter.....	4
4RC61 Socket Adapter	4
4RC65 4-Hole Pyramid Adapter.....	5
4RC117 3-Arm Rotatable Adapter.....	5
4RC118 3-Arm Rotatable Adapter with Pyramid	5
4RC69 Thermoplastic Socket Adapter	5
4RC66 Tube Clamp Adapter with Pyramid.....	5
4RC110 4-Ear Rotatable Socket Adapter.....	5
4RC111 4-Ear Female Socket Adapter	6
4RC255 Female Double Adapter	6
4RC211 Pyramid Double Adapter	6
4RC76 Short Tube Adapter.....	6

KNEE JOINTS AND HIP JOINTS7

2SH1200 Hydraulic Geometric Knee Joint.....	7
2SH1000 Hydraulic Geometric Knee Joint.....	7
2SR500 Pneumatic Knee Joint	7
2SR480 Monocentric Pneumatic Knee Joint.....	8
2SR100 Pneumatic Knee Joint.....	8
2SR430 Pneumatic Knee Joint.....	8
2SR330 Four-bar knee joint.....	9
2SR120 Four -Bar Knee Joint with Manual Lock	9
2SR380 Four-Bar Knee Joint.....	9
2SR380M Four-Bar Knee Joint with Manual Lock	9
3R40A Monocentric knee Joint with Manual Lock.....	10
2SR350L Polycentric knee Joint with Manual lock.....	10

3R15 Single Axis Knee Joint.....	10
2SR580 Polycentric Knee Joint with Manual Toggle lock..	10
21B30 Extension Assist for Knee joint 3R15S /3R15T.....	10
3R20 Four-bar Knee Joint w/ Pyramid.....	11
3R20B Four-bar Knee Joint w/ L-Anchor	11
3R35 Four-bar Knee Joint w/ Pyramid.....	11
3R35B Single Axis Knee Joint w/ L-Anchor	11
3R21 Through Knee Joint w/ L-Anchor.....	12
3R23 Through Knee Joint L-Anchor w/ Manual Lock.....	12
3R17 Single Axis Knee Joint Pyramid w/ Manual Lock.....	12
3R22 Single Axis Knee Joint w/ Pyramid	12
2SR440 Pneumatic Knee Joint	13
7SR160 Four-Bar Hip Joint.....	13
7E5A Single Axis Hip Joint with Manual Lock	13
7E4A Single Axis Hip Joint with Manual Lock	13
7E8 Four-Bar Hip Joint	14
7E7 Single Axis Hip Joint.....	14
4R57 Rotation Adapter.....	14
4R157 Quick-release Adapter.....	14

MODULAR PROSTHETIC FEET15

1FC40 Low Profile Carbon Foot	15
1FC45 Carbon Fiber Foot.....	15
1FC50 Carbon Fiber Foot.....	16
1FC10 Carbon Foot.....	17
1FC25 Low Profile Carbon Foot	17
1FC65 Carbon Fiber Foot.....	17
1FC60 Carbon Fiber Foot.....	18
1FC55 Low Profile Carbon Fiber Foot	18
1FC70 Carbon Fiber Foot.....	18
1FC100 Low Profile Carbon Fiber Foot	19
1FC200 Carbon Fiber Foot.....	19
KIT of 1FC40 Carbon Fiber Foot/Foot Shell/Sock	20
KIT of 1FC45 Carbon Fiber Foot/Foot Shell/Sock	21
KIT of 1FC50 Carbon Fiber Foot/Foot Shell/Sock	22
KIT of 1FC10 Carbon Fiber Foot/Foot Shell/Sock	23
KIT of 1FC25 Carbon Fiber Foot/Foot Shell/Sock	24
KIT of 1FC65 Carbon Fiber Foot/Foot Shell/Sock	25
KIT of 1FC60 Carbon Fiber Foot/Foot Shell/Sock	26
KIT of 1FC55 Carbon Fiber Foot/Foot Shell/Sock	27
KIT of 1FC70 Carbon Fiber Foot/Foot Shell/Sock	28
KIT of 1FC100 Low Profile Carbon Fiber Foot.....	29
KIT of 1FC200 High Profile Carbon Fiber Foot.....	30
1FS Carbon Fiber Foot (Pyramid).....	31
1FM Carbon Fiber Foot (Syme).....	31

2R44 Syme Lamination Support	31	4R89 3-Arm Rotatable Pyramid Adapter	45
1N01 Foot Shell	32	4R42 3-Arm Pyramid Adapter	45
1N4200 Quantum Foot Shell, Toe-split	32	4R43 3-Arm Pyramid Adapter with Hole	45
1N3200 Quantum Foot Shell, Non Toe-split.....	32	4R44 3-Arm Lamination Anchor	45
1E20 Dynamic Foot	33	4R123 4-Arm Lamination Anchor.....	45
1E25 Dynamic Foot	33	4R113S Lengthened Female Insert Stainless Steel.....	45
1N05W SACH Foot w/ Toe Split.....	34	4R113T Lengthened Female Insert Titanium	45
2N1 Foot Adapter.....	34	4R21 Tube Clamp Adapter.....	46
2N1-1 Foot Adapter w/ 2 Pins	34	4R6 Tube Clamp Pyramid Adapter	46
2R14 Foot Connection Plate for SACH Foot.....	34	4R20 Angled Tube Clamp Adapter.....	46
1S03W Two Hole Single Axis Foot.....	35	4R202 Angled Tube Clamp Adapter.....	46
1S23W Two Hole Single Axis Foot with Toe Split.....	35	4R28 Length Adjustment Adapter	46
2S2 Foot Adapter for Two Hole Single Axis Foot	35	4R103 Slid Adapter	46
2R22 Foot Connection Cap for Single-Axis-Foot Adapter.	36	4R30T Eccentric Tube Clamp Adapter.....	46
1N03W Low Profile Foot.....	36	2R2 Tube Assembly	47
2N33 Foot Adapter for 1N03W Foot.....	36	2R3 Tube Assembly	47
2N34 Foot Adapter for 1N03W Foot.....	36	2R11 Connection Tube Carbon Fiber.....	47
1S04W One Hole Single Axis Foot	37	2R12 Connection Tube Aluminum	47
1S24W One Hole Single Axis Foot with Toe Split	37	2R50 Length Adjustable Tube Adapter	47
2S1 Foot Adapter	37	2R38 Angled Tube Assembly	47
1FC1 Foot Shell with Cover	38	4R22 4 Hole Female Adapter.....	48
1FC2 Foot Shell without Cover	38	4R23 4-Hole Pyramid Adapter	48
1FO1 Foot Shell with Cover.....	39	4R24 4-Hole Pyramid Adapter with Hole.....	48
1FO2 Foot Shell without Cover.....	39	4R77 4 Hole Rotatable Pyramid Adapter	48
1FO1-EVO Foot Shell with Cover	40	4R96 4-Hole Rotatable Female Adapter	48
1FO2-EVO Foot Shell without Cover	40	4R98 4-Hole Rotatable Base	48
1NA8 Slip-resistant and Water-proof Foot	41	4R47 4-Hole Rotatable Female Adapter	48
99B10 Sock for Carbon foot.....	41	4R73 Eccentric Adapter	49
1P01 Pirogoff Foot.....	42	4R74 Eccentric Adapter	49
1P02 Pirogoff Foot w/ Reinforcing Cloth	42	5R1 Socket Attachment Block.....	49
2WB5 Foot Attachment Block for Pirogoff Foot.....	42	5R5 BK Thermoplastic Socket Adapter.....	49
1M10 Multi-flex Foot	43	4R19 BK Thermoplastic Socket Adapter	49
1MA Multi-flex Ankle.....	43	4R38 AK Thermoplastic Socket Adapter	49
5MA Snubber Kit for Multi-flex Ankle.....	43	4R105 Slid Adapter	50

MODULAR COMPONENTS 44

4R63 4-Ear Socket Adapter	44	4R72 Double Adapter.....	50
4R64 4-Ear Socket Adapter with Hole.....	44	4R70 Short Tube Adapter	50
4R111 4-Ear Rotatable Socket Adapter	44	4R84 Double Adapter with Pyramid	50
4R133 4-Ear Rotatable Pyramid Adapter	44	4R64A 4-Ear Socket Adapter	51
4R112 4-Ear Female Socket Adapter.....	44	4R21A Tube Clamp Adapter	51
4R122 4-Ear Lamination Anchor	44	2R2A AK Tube Assembly	51
4R136 Pyramid Insert	44	2R3A BK Tube Assembly	51
4R131 Female Insert	44	2N1A Foot Adapter	51
4R41 3-Arm Rotatable Female Adapter	45	4R22A 4-Hole Female Adapter	51
		4R24A 4-Hole Pyramid Adapter	51
		4R30A Eccentric Tube Clamp Adapter.....	51
		4R32A Eccentric Tube Adapter	52

4R20A Angled Tube Adapter	52
4R25A BK Thermoplastic Socket Adapter with Tube	52
4R26A BK Thermoplastic Socket Adapter	52
4R29A AK Thermoplastic Socket Adapter	52
4R37A AK Rotatable Socket Adapter	52
4R96A 4-Hole Rotatable Female Adapter	52
4R72A Double Adapter	53
4R84A Double Adapter with Pyramid	53
4R70A Short Tube Adapter	53

LOCK & LINER SYSTEMS 54

6BS20-1 Pyramid Shuttle Lock	54
6BS20-2 Female Shuttle Lock	54
6BS30 Build-in Shuttle Lock	54
6BS40 Shuttle Lock	54
6BS50 Shuttle Lock with Pyramid	55
6BT50 Shuttle Lock	55
6BT51 Shuttle Lock	55
6BS3140 Base Shuttle Lock	56
6AC3140 lamination Dummy	56
6CBS50 Child Shuttle Lock	56
6BL13250 Shuttle Lock for Upper Limb	56
3010L Transtibial silicone liner	57
3090L Transfemoral silicone liner	57
AKDT/AKFR Extreme™ Liner	58
AKDTHD/AKFRHD Extreme™ HD Liner	58
SFX Flex Sleeve	58
ECDTHD/ECFRHD Eco™ Liner	59
ELDT/ELFR Easy Gel Liner®	59
SPDT/SPFR Superior Performance Liner	60
SPDTHD/SPFRHD Superior Performance HD Liner	60
CLBNDT/CLBNFR Economical Liner	61
PLDTHD/PLFRHD HD Economical Liner	61
USHSL/USHSC UltraSeal Silicone Liner	62
USLSL/USLSC UltraSeal Silicone Liner	62
USUSL/ USUSC UltraSeal Silicone Liner	62
GPDT/GPFR General Purpose Liner	63
503D6 Gel. Sock	63
616S-T Silicone Comfort Pad	63

UPPER PROSTHESES 64

12P5 Elbow Set-up	64
12P1 Elbow Hinge	64
12P4 Elbow Hinge	64

12HZ4 Shoulder Joint	64
13R11 Cosmetic Foam	64
12HZ50 Elbow-Arm Component	65
12HZ51 Elbow-Arm Component	65
12HZ56 Elbow-Arm Component	65
12HZ60 Shoulder Disarticulation Component	65
HS30 Hand Cable Controlled	66
HS32 Hand Cable Controlled	66
HW30 Multi-wrist Unit	66
HZ30 Passive Hand	66
HZ35 Passive Hand	66
HZ32 Passive Hand	66

SILICON COSMETIC PRODUCTS 67

CHS70 Child Cosmetic Silicone Glove	67
CHS80 Child Mechanical Glove	67
CHZ30 Child Passive Hand	67
HS70F Female Cosmetic Silicone Glove	68
HS70F-Z Female Cosmetic Glove with Zip & Filler	68
HS70F-BF Female Cosmetic Glove with Filler & Bolt	68
HS70F-XF Female Cosmetic Glove with Filler	68
HS70M Male Cosmetic Silicone Glove	69
HS70M-Z Male Cosmetic Glove with Zip & Filler	69
HS70M-BF Male Cosmetic Glove with Filler & Bolt	69
HS70M-XF Male Cosmetic Glove with Filler	69
HS80M Male Myo./Mechanical Glove	70
HS80F Female Myo./Mechanical Glove	70
HS70-SCM Customized Partial Silicone prostheses	70
HS200 Standard Silicone Fingers Set	71
HS201 Customized Fingers	71
HS300-SCM Customized Foot Toes	71
1HS10 Standard Silicone Footshell	72
1HS10-Z Standard Silicone Footshell with Zip	72
1HS10-SCM Customized Foot	72
14HE20 Silicone Cosmetic Ear	72

ACCESSORIES AND MATERIALS 74

6R20 AK Molded Foam Cover	74
6R21 AK Water-proof Cover	74
6R23 AK Foam Cover	74
6R16 BK Water-proof Cover	74
6R18 BK Foam Cover	74
6R19 BK Foam Cover	74
99B16 Perlon Cosmetic Stocking	75

99B26 Perlon Cosmetic Stocking.....	75
503A50 Adhesive Tape	75
21ES10 Easy Donny Sleeve.....	75
21B37 AK Suspension Sleeve	76
501F3 Cotton Stump Sock.....	76
501U3 Nylon Stump Sock.....	76
501T3 Terry Cotton Stump Sock.....	76
21PF PVA Film.....	77
21P20 PVA Lamination Bag.....	77
6T2 Socket Cone (BK).....	77
6T1 Socket Cone (AK).....	77
22CF Fiberglass Cloth	78
23CF Carbon Fiber Stockinette	78
29NL Nylon Stockinette.....	78
24FG Fiberglass Stockinette.....	78
25PL Perlon Stockinette.....	78
26CT Cotton Stockinette.....	78
21VR551 Expulsion Valve.....	79
21VR552 Expulsion Valve.....	79
21VH01 Button Valve.....	79
21VH02 Auto Valve	79
21V15 Auto Valve.....	79
21V03 Flat Rubber Valve	80
21VS10 Valve Seat with Tube.....	80
21VS20 Valve Seat Ring.....	80
27ES EVA Sheet.....	80
36VBL Velcro Belt with Buckle	81
37CMP Comfort Pad.....	81
38VBF Velcro Belt with Buckle.....	81
34TNB Triangle Nylon Buckle	81
35TNB Triangle Nylon Buckle	81
41ADV Adhesive Elastic Strap.....	82
42SRC Sunk Head Rivet	82
43SRA Sunk Head Rivet.....	82
44DCR Double Caps Rivet	82
50SCR Single Cap Rivet.....	82
623TP11-1 Thermal paper	83
28MP Multicolor Soft Sheet.....	84
41PES Thermoplastic Sheet (Polyethylene)	84
42PPS Thermoplastic Sheet (Polythylene)	84
28MP30 EVA Sheet for Arch Insole Pad (Multicolor).....	84
28MC30 EVA Sheet for Arch Insole Pad (Monochrome)...	85
28TH30 EVA Sheet for Arch Insole Pad (Tri-Layer)	85
31MLS Velcro Loop Strap	85
32MHS Velcro hook Strap.....	85
33ADV Adhesive Velcro Hook Strap	86

40BFS Brushed Fabric Straps	86
39VFS Velcro Fabric Strap	86

TOOLS..... 87

743A11 Casting Apparatus (without handrail).....	87
743A11A Casting Apparatus with handrail	87
743A15 Casting Apparatus with handrail	87
711S1 Bending Iron	87
716Y1 Surform Blade, Flat.....	87
716Y3 Surform Blade, Flat-Round.....	87
716Y4 Surform Blade, Rounded	87
718H12 Fuchs Draw Knife	88
719G6 Undulate Scissor.....	88
756E1 Hand Sealing Iron.....	88
749F Sanding Drum.....	88
749Y Sanding Sleeve	88
749Z9 Conical Sanding Drum.....	89
749Y26 Sanding Sleeve	89
729W3 Rasp Head	89
729F3 Rasp Head.....	90

ORTHOTIC COMPONENTS..... 91

15WJA/B/C Ankle Joint.....	91
15DH Double Action Ankle Hinge	91
15DP Double Action Ankle Hinge.....	91
15EA Elastomer AFO Joint	91
15FA Free Motion Ankle Joint	91
16SL Swiss Lock Hinge with Self-locking & Stick	92
16SL-1 Swiss Lock Hinge with Self-locking	92
16DL Drop Lock Hinge.....	92
16DL Child Drop Lock Hinge.....	92
17PK Axis Posterior Hinge.....	92
17BLH Bale Lock Hinge.....	93
18BLH Bale Lock Hinge.....	93
17H100 Bi-axial RGO hip joint system.....	93
17H300 ARGO hip joint system	93

Index of Product Number (1-9&A-Z)

Item Number/Series	Description	Page
12HZ4	Shoulder Joint	64
12HZ50	Elbow-Arm Component	65
12HZ51	Elbow-Arm Component	65
12HZ56	Elbow-Arm Component	65
12HZ60	Shoulder Disarticulation Component	65
12P1	Elbow Hinge	64
12P4	Elbow Hinge	64
12P5	Elbow Set-up	64
13R11	Cosmetic Foam	64
14HE20	Silicone Cosmetic Ear	72
15DH	Double Action Ankle Hinge	91
15DP	Double Action Ankle Hinge	91
15EA	Elastomer AFO Joint	91
15FA	Free Motion Ankle Joint	91
15WJA	B/C Ankle Joint	91
16DL	Drop Lock Hinge	92
16DL	Child Drop Lock Hinge	92
16SL	Swiss Lock Hinge with Self-locking	92
16SL	Swiss Lock Hinge with Self-locking	92
17BLH	Bale Lock Hinge	93
17H100	Bi-axial RGO hip joint system	93
17H300	ARGO hip joint syste	93
17PK	Axis Posterior Hinge	92
18BLH	Bale Lock Hinge	93
1E20	Dynamic Foot	33
1E25	Dynamic Foot	33
1EC21	Dynamic Foot for Children	3
1FC1	Foot Shell with Cover	38
1FC10	Carbon Foot	17
1FC10 KIT	1FC10 Carbon Fiber Foot/Foot Shell/Sock	23
1FC2	Foot Shell without Cover	38
1FC25	Low Profile Carbon Foot	17
1FC25 KIT	1FC25 Carbon Fiber Foot/Foot Shell/Sock	24
1FC40	Low Profile Carbon Foot	15
1FC40 KIT	1FC40 Carbon Fiber Foot/Foot Shell/Sock	20
1FC45	Carbon Fiber Foot	15
1FC45 KIT	1FC45 Carbon Fiber Foot/Foot Shell/Sock	21
1FC50	Carbon Fiber Foot	16
1FC50 KIT	1FC50 Carbon Fiber Foot/Foot Shell/Sock	22

1FC55	Low Profile Carbon Fiber Foot	18
1FC55 KIT	1FC55 Carbon Fiber Foot/Foot Shell/Sock	27
1FC60	Carbon Fiber Foot	18
1FC60 KIT	1FC60 Carbon Fiber Foot/Foot Shell/Sock	26
1FC65	Carbon Fiber Foot	17
1FC65 KIT	1FC65 Carbon Fiber Foot/Foot Shell/Sock	25
1FC70	Carbon Fiber Foot	18
1FC70 KIT	1FC70 Carbon Fiber Foot/Foot Shell/Sock	28
1FC100	Low Profile Carbon Fiber Foot	19
1FC100 KIT	1FC100 Low Profile Carbon Fiber Foot	29
1FC200	Carbon Fiber Foot	19
1FC200 KIT	1FC200 High Profile Carbon Fiber Foot	30
1FM	Carbon Fiber Foot (Syme)	31
1FO1	Foot Shell with Cover	39
1FO1	EVO Foot Shell with Cover	40
1FO2	Foot Shell without Cover	39
1FO2	EVO Foot Shell without Cover	40
1FS	Carbon Fiber Foot (Pyramid)	31
1HS10	Standard Silicone Footshell	72
1HS10F-Z	Standard Silicone Footshell with Zip	72
1HS10-SCM	Customized Foot	72
1M10	Multi-flex Foot	43
1MA	Multi-flex Ankle	43
1N01	Foot Shell	32
1N03W	Low Profile Foot	36
1N04	SACH Foot for Children	3
1N04B	SACH Foot, Toe Split for Children	3
1N05W	SACH Foot w/ Toe Split	34
1N3200	Quantum Foot Shell, Non Toe-split	32
1N4200	Quantum Foot Shell, Toe-split	32
1NA8	Slip-resistant and Water-proof Foot	41
1P01	Pirogoff Foot	42
1P02	Pirogoff Foot w/ Reinforcing Cloth	42
1S03W	Two Hole Single Axis Foot	35
1S04W	One Hole Single Axis Foot	37
1S23W	Two Hole Single Axis Foot with Toe Split	35
1S24W	One Hole Single Axis Foot with Toe Split	37
21B30	Extension Assist for Knee joint 3R15S /3R15T	10
21B37	AK Suspension Sleeve	76
21ES10	Easy Donny Sleeve	75
21P20	PVA Lamination Bag	77
21PF	PVA Film	77
21V03	Flat Rubber Valve	80
21V15	Auto Valve	79

21VH01	Button Valve	79
21VH02	Auto Valve	79
21VR551	Expulsion Valve	79
21VR552	Expulsion Valve	79
21VS10	Valve Seat with Tube	80
21VS20	Valve Seat Ring	80
22CF	Fiberglass Cloth	78
23CF	Carbon Fiber Stockinette	78
24FG	Fiberglass Stockinette	78
25PL	Perlon Stockinette	78
26CT	Cotton Stockinette	78
27ES	EVA Sheet	80
28MC30	EVA Sheet for Arch Insole Pad (Monochrome)	85
28MP	Multicolor Soft Sheet	84
28MP30	EVA Sheet for Arch Insole Pad (Multicolor)	84
28TH30	EVA Sheet for Arch Insole Pad (Tri-Layer)	85
29NL	Nylon Stockinette	78
2N1	Foot Adapter	34
2N1	Foot Adapter w/ 2 Pins	34
2N1A	Foot Adapter	51
2N33	Foot Adapter for 1N03W Foot	36
2N34	Foot Adapter for 1N03W Foot	36
2R11	Connection Tube Carbon Fiber	47
2R12	Connection Tube Aluminum	47
2R14	Foot Connection Plate for SACH Foot	34
2R2	Tube Assembly	47
2R22	Foot Connection Cap for Single-Axis-Foot Adapter	36
2R2A	AK Tube Assembly	51
2R3	Tube Assembly	47
2R38	Angled Tube Assembly	47
2R3A	BK Tube Assembly	51
2R44	Syme Lamination Support	31
2R45	Length Adjustable Tube Adapter	47
2RC40	Foot Adapter	4
2RC41	Tube Assembly	4
2S1	Foot Adapter	37
2S2	Foot Adapter for Two Hole Single Axis Foot	35
2SH1000	Hydraulic Geometric Knee Joint	7
2SH1200	Hydraulic Geometric Knee Joint	7
2SR100	Pneumatic Knee Joint	8
2SR120	Bar Knee Joint with Manual Lock	9
2SR330	bar knee joint	9
2SR350L	Polycentric knee Joint with Manual lock	10
2SR380	Bar Knee Joint	9
2SR380M	4-Bar Knee Joint with Manual Lock	9

2SR430	Pneumatic Knee Joint	8
2SR440	Pneumatic Knee Joint	13
2SR480	Monocentric Pneumatic Knee Joint	8
2SR580	Polycentric Knee Joint with Manual Toggle lock	10
2SR500	Pneumatic Knee Joint	7
2WB5	Foot Attachment Block for Pirogoff Foot	42
3010L	Transtibial silicone liner	57
3090L	Transfemoral silicone liner	57
31MLS	Velcro Loop Strap	85
32MHS	Velcro hook Strap	85
33ADV	Adhesive Velcro Hook Strap	86
34TNB	Triangle Nylon Buckle	81
35TNB	Triangle Nylon Buckle	81
36VBL	Velcro Belt with Buckle	81
37CMP	Comfort Pad	81
38VBF	Velcro Belt with Buckle	81
39VFS	Velcro Fabric Strap	86
3R15	Single Axis Knee Joint	10
3R17	Single Axis Knee Joint Pyramid w/ Manual Lock	12
3R20	Four-bar Knee Joint w/ Pyramid	11
3R20B	B Four-bar Knee Joint w/ L-Anchor	11
3R21	Through Knee Joint w/ L-Anchor	12
3R22	Single Axis Knee Joint w/ Pyramid	12
3R23	Through Knee Joint L-Anchor w/ Manual Lock	12
3R35	Four-bar Knee Joint w/ Pyramid	11
3R35B	B Single Axis Knee Joint w/ L-Anchor	11
3R40A	A Monocentric knee Joint with Manual Lock	10
3RC10	Single Axis Knee for Children	1
3RC313	Knee Joint for Children	2
3RC45	Pneumatic Knee for Children	1
3RC60	Knee for Children	1
40BFS	Brushed Fabric Straps	86
41ADV	Adhesive Elastic Strap	82
41PES	Thermoplastic Sheet (Polyethylene)	84
42PPS	Thermoplastic Sheet (Polyethylene)	84
42SRC	Sunk Head Rivet	82
43SRC	Sunk Head Rivet	82
44DCR	Double Caps Rivet	82
451F3	Cotton Stump Sock	76
451T3	Terry Cotton Stump Sock	76
451U3	Nylon Stump Sock	76
453A50	Adhesive Tape	75
453D6	Gel. Sock	63
45SCR	Single Cap Rivet	82
4R103	Slide Adapter	46

4R105	Slide Adapter	50
4R111	Ear Rotatable Socket Adapter	44
4R112	Ear Female Socket Adapter	44
4R113S	Lengthened Female Insert Stainless Steel	45
4R113T	Lengthened Female Insert Titanium	45
4R122	Ear Lamination Anchor	44
4R123	Arm Lamination Anchor	45
4R131	Female Insert	44
4R133	Ear Rotatable Pyramid Adapter	44
4R136	Pyramid Insert	44
4R157	Quick-release Adapter	14
4R19	BK Thermoplastic Socket Adapter	49
4R20	Angled Tube Clamp Adapter	46
4R202	Angled Tube Clamp Adapter	46
4R20A	Angled Tube Adapter	52
4R21	Tube Clamp Adapter	46
4R21A	Tube Clamp Adapter	51
4R22	Hole Female Adapter	48
4R22A	4-Hole Female Adapter	51
4R23	Hole Pyramid Adapter	48
4R24	Hole Pyramid Adapter with Hole	48
4R24A	4-Hole Pyramid Adapter	51
4R25A	BK Thermoplastic Socket Adapter with Tube	52
4R26A	BK Thermoplastic Socket Adapter	52
4R28	Length Adjustment Adapter	46
4R29A	AK Thermoplastic Socket Adapter	52
4R30A	Eccentric Tube Clamp Adapter	51
4R30T	Eccentric Tube Clamp Adapter	46
4R32A	Eccentric Tube Adapter	52
4R37A	AK Rotatable Socket Adapter	52
4R38	AK Thermoplastic Socket Adapter	49
4R41	Arm Rotatable Female Adapter	45
4R42	Arm Pyramid Adapter	45
4R43	Arm Pyramid Adapter with Hole	45
4R44	Arm Lamination Anchor	45
4R47	Hole Rotatable Female Adapter	48
4R57	Rotation Adapter	14
4R6	Tube Clamp Pyramid Adapter	46
4R63	Ear Socket Adapter	44
4R64	Ear Socket Adapter with Hole	44
4R64A	4-Ear Socket Adapter	51
4R70	Short Tube Adapter	50
4R70A	Short Tube Adapter	53
4R72	Double Adapter	50

4R72A	Double Adapter	53
4R73	Eccentric Adapter	49
4R74	Eccentric Adapter	49
4R77	4 Hole Rotatable Pyramid Adapter	48
4R84	Double Adapter with Pyramid	50
4R84A	Double Adapter with Pyramid	53
4R89	Arm Rotatable Pyramid Adapter	45
4R96	Hole Rotatable Female Adapter	48
4R96A	4-Hole Rotatable Female Adapter	52
4R98	Hole Rotatable Base	48
4RC110	Ear Rotatable Socket Adapter	5
4RC111	Ear Female Socket Adapter	6
4RC117	Arm Rotatable Adapter	5
4RC118	Arm Rotatable Adapter with Pyramid	5
4RC211	Pyramid Double Adapter	6
4RC255	Female Double Adapter	6
4RC60	Hole Female Adapter	4
4RC61	Socket Adapter	4
4RC65	Hole Pyramid Adapter	5
4RC66	Tube Clamp Adapter with Pyramid	5
4RC67	Ear Socket Adapter	4
4RC69	Thermoplastic Socket Adapter	5
4RC75	Angled Tube Adapter for Children	2
4RC76	Short Tube Adapter	6
4RC83	Tube Clamp Adapter	4
5MA	Snubber Kit for Multi-flex Ankle	43
5R1	Socket Attachment Block	49
5R5	BK Thermoplastic Socket Adapter	49
616S	Silicone Comfort Pad	63
623TP11	Thermal paper	83
6AC3140	Lamination Dummy	56
6BL13250	Shuttle Lock for Upper Limb	56
6BS20-1	Pyramid Shuttle Lock	54
6BS20-2	Female Shuttle Lock	54
6BS30	Build-in Shuttle Lock	54
6BS3140	Base Shuttle Lock	56
6BS40	Shuttle Lock	54
6BS50	Shuttle Lock with Pyramid	55
6BT50T	Shuttle Lock	55
6BT51T	Shuttle Lock	55
6CBS45	Child Shuttle Lock	56
6R16	BK Water-proof Cover	74
6R18	BK Foam Cover	74
6R19	BK Foam Cover	74

6R20	AK Molded Foam Cover	74
6R21	AK Water-proof Cover	74
6R23	AK Foam Cover	74
6T1	Socket Cone (AK)	77
6T2	Socket Cone (BK)	77
711S1	Bending Iron	87
716Y1	Surform Blade, Flat	87
716Y3	Surform Blade, Flat-Round	87
716Y4	Surform Blade, Rounded	87
718H12	Fuchs Draw Knife	88
719G6	Undulate Scissor	88
729F3	Rasp Head	90
729W3	Rasp Head	89
743A11	Casting Apparatus (without handrail)	87
743A11A	Casting Apparatus with handrail	87
743A15	Casting Apparatus with handrail	87
749F	Sanding Drum	88
749Y	Sanding Sleeve	88
749Y26	Sanding Sleeve	89
749Z9	Conical Sanding Drum	89
756E1	Hand Sealing Iron	88
7E4A	Single Axis Hip Joint with Manual Lock	13
7E5A	Single Axis Hip Joint with Manual Lock	13
7E7	Single Axis Hip Joint	14
7E8	Four-Bar Hip Joint	14
7EC10	Hip Joint for Children	2
7SR160	Four-Bar Hip Joint	13
99B10	Sock for Carbon foot	41
99B16	Perlon Cosmetic Stocking	75
99B26	Perlon Cosmetic Stocking	75
AKDT	Extreme™ Liner	58
AKDTHD	Extreme™ HD Liner	58
CHS70	Child Cosmetic Silicone Glove	67
CHS80	Child Mechanical Glove	67
CHZ30	Child Passive Hand	67
CLBNDT	Economical Liner	61
ECDTHD	Eco™ Liner	59
ELDT	Easy Gel Liner ®	59
GPDT	General Purpose Liner	63
HS200	Standard Silicone Fingers Set	71
HS201	Customized Fingers	71
HS30	Hand Cable Controlled	66
HS300-SCM	Customized Foot Toes	71
HS32	Hand Cable Controlled	66
HS70F	Female Cosmetic Silicone Glove	68

HS70F-BF	Female Cosmetic Glove with Filler & Bolt	68
HS70F-XF	Female Cosmetic Glove with Filler	68
HS70F-Z	Female Cosmetic Glove with Zip	68
HS70M	Male Cosmetic Silicone Glove	69
HS70M-BF	Male Cosmetic Glove with Filler & Bolt	69
HS70M-XF	Male Cosmetic Glove with Filler	69
HS70M-Z	Male Cosmetic Glove with Zip	69
HS70-SCM	Customized Partial Silicone prostheses	70
HS80F	Female Myo./Mechanical Glove	70
HS80M	Male Myo./Mechanical Glove	70
HW30	Multi-wrist Unit	66
HZ30	Passive Hand	66
HZ32	Passive Hand	66
HZ35	Passive Hand	66
PLDTHD	HD Economical Liner	61
SFX	Flex Sleeve	58
SPDT	Superior Performance Liner	60
SPDTHD	Superior Performance HD Liner	60
USHSL	UltraSeal Silicone Liner	62
USLSL	UltraSeal Silicone Liner	62
USUSL	UltraSeal Silicone Liner	62

Lower Limb Prostheses for Children

Lower Limb for Children

Knee & Hip Joints

Modular Feet

Modular Components

Lock & Liner

Upper Prost.

Silicon Cosmetic Prost.

Accessories & Materials

Tools

Ortho. Components



3RC10 Single Axis Knee for Children

- Total Height: 145 mm
- Impact Level: Low-Moderate

Article No.	Material	Product Weight	Weight Limit
3RC10	Aluminum	183 g	45 kg



3RC45 Pneumatic Knee for Children

- Total Height: 155 mm
- Impact Level: Low-Moderate
- There is 0~4 mm shift in A-P direction on proximal connection surface
- Max. flexion: 150°

Article No.	Material	Product Weight	Weight Limit
3RC45	Aluminum	507 g	45 kg

3RC60 4-linkage Knee for Children

- Build Height: 105 mm
- Max. flexion: 140°

Article No.	Proximal Connection	Material	Product Weight	Weight Limit
3RC60	Pyramid	Aluminum	320 g	45 kg
3RC60B	L-Anchor	Aluminum	330 g	45 kg

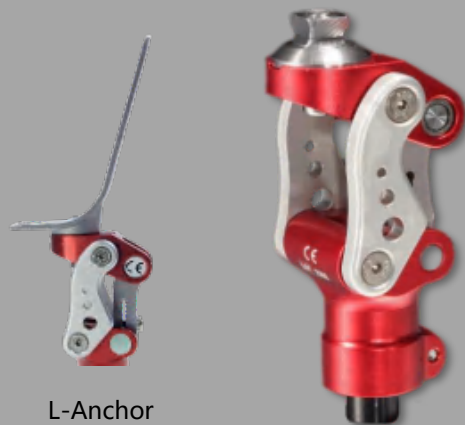

L-Anchor

3RC313 Knee Joint for Children

- Lightweight, 4- bar, polycentric design
- Friction swing control and extension assist
- Adjustable stability control
- Free motion setting available
- Rotatable knee disarticulation adapter available
- Weight Limit: 55 kg
- Max. Flexion: 140°
- Total Height: 110mm

Article No.	Product Weight	Weight Limit	Descriptions
3RC313P	386 g	55 kg	Knee joint with pyramid
3RC313PM	412 g	55 kg	Knee joint with Pyramid & Manual lock
3RC313D	438 g	55 kg	Knee joint for disarticulation with 3-prong adapter
3RC313DM	463 g	55 kg	Knee joint for disarticulation with 3-prong adapter & manual lock

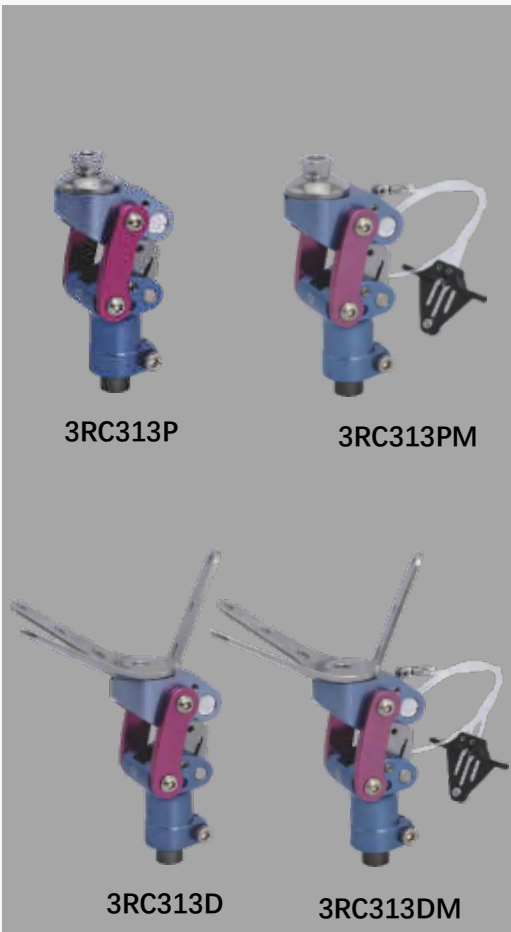

7EC10 Hip Joint for Children

- Lightweight, 4- bar, polycentric design
- Friction swing control and extension assist
- Adjustable stability control
- Rotatable knee disarticulation adapter available
- Weight Limit: 55 kg
- Max. Flexion: 110°
- Total Height: 146mm

Article No.	Total Height	Weight Limit
7EC10	146mm	55 kg



4RC75 Angled Tube Adapter for Children

Article No.	Angle	Material	Product Weight	Weight Limit
4RC75S	10°	Stainless Steel	84 g	60 kg
4RC75T	10°	Titanium	53 g	60 kg



Lower Limb for Children

Knee & Hip Joints

Modular Feet

Modular Components

Lock & Liner

Upper Prost.

Silicon Cosmetic Prost.

Accessories & Materials

Tools

Ortho. Components



1EC21 Dynamic Foot for Children

- Heel Height 5-7 mm, separate toe
- Foot material polyurethane
- Keel material: Carbon Fiber, Reinforced polymer composites
- Specially designed keel provides energy return

Article No.	Size	Side	Thread	Weight	
				Limit	Heel Height
1EC21-14R	14 cm	right	M8	60 kg	5 mm
1EC21-14L	14 cm	left	M8	60 kg	5 mm
1EC21-15R	15 cm	right	M8	60 kg	5 mm
1EC21-15L	15 cm	left	M8	60 kg	5 mm
1EC21-16R	16 cm	right	M8	60 kg	5 mm
1EC21-16L	16 cm	left	M8	60 kg	5 mm
1EC21-17R	17 cm	right	M8	80 kg	7 mm
1EC21-17L	17 cm	left	M8	80 kg	7 mm
1EC21-18R	18 cm	right	M8	80 kg	7 mm
1EC21-18L	18 cm	left	M8	80 kg	7 mm
1EC21-19R	19 cm	right	M8	80 kg	7 mm
1EC21-19L	19 cm	left	M8	80 kg	7 mm



1N04 SACH Foot for Children

Heel Height 5 mm.
Foot of polyurethane
Forefoot is flat-convex

Article No.	Size	Side	Thread	Weight	
				Limit	Heel Height
1N04-12R	12 cm	right	M8	35 kg	5 mm
1N04-12L	12 cm	left	M8	35 kg	5 mm
1N04-13R	13 cm	right	M8	35 kg	5 mm
1N04-13L	13 cm	left	M8	35 kg	5 mm



1N04B SACH Foot, Toe Split for Children

- Toe Split
- Heel Height 5-7 mm
- Foot material polyurethane

Article No.	Size	Side	Thread	Weight	
				Limit	Heel Height
1N04B-14R	14 cm	right	M8	50 kg	5 mm
1N04B-14L	14 cm	left	M8	50 kg	5 mm
1N04B-15R	15 cm	right	M8	50 kg	5 mm
1N04B-15L	15 cm	left	M8	50 kg	5 mm
1N04B-16R	16 cm	right	M8	50 kg	5 mm
1N04B-16L	16 cm	left	M8	50 kg	5 mm
1N04B-17R	17 cm	right	M8	50 kg	7 mm
1N04B-17L	17 cm	left	M8	50 kg	7 mm
1N04B-18R	18 cm	right	M8	60 kg	7 mm
1N04B-18L	18 cm	left	M8	60 kg	7 mm
1N04B-19R	19 cm	right	M8	60 kg	7 mm
1N04B-19L	19 cm	left	M8	60 kg	7 mm



4RC67 4-Ear Socket Adapter

Article No.	Material	Product Weight	Weight Limit
4RC67S	Stainless Steel	50 g	60 kg
4RC67T	Titanium	32 g	60 kg
4RC67A	Aluminum	28 g	45 kg



4RC83 Tube Clamp Adapter

Article No.	Material	Product Weight	Weight Limit
4RC83S	Stainless Steel	70 g	60 kg
4RC83T	Titanium	45 g	60 kg
4RC83A	Aluminum	38 g	45 kg



2RC40 Foot Adapter

Article No.	Material	Product Weight	Weight Limit
2RC40S	Stainless Steel	55 g	60 kg
2RC40T	Titanium	52 g	60 kg
2RC40A	Aluminum	49 g	45 kg

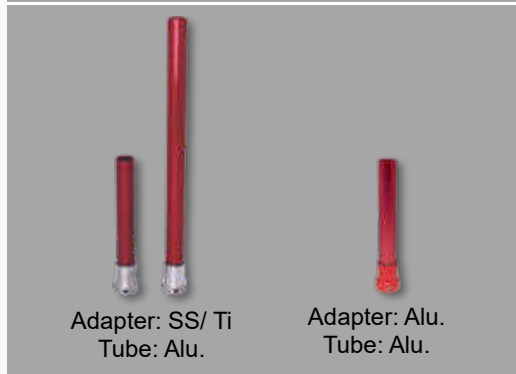

2RC41 Tube Assembly

Article No.	Material	Product Weight	Weight Limit
2RC41S-160	SS & Alu.	110 g	60 kg
2RC41S-310	SS & Alu.	170 g	60 kg
2RC41T-160	Ti. & Alu.	95 g	60 kg
2RC41T-310	Ti. & Alu.	155 g	60 kg
2RC41A-160	Alu. & Alu.	83 g	45 kg
2RC41A-310	Alu. & Alu.	133 g	45 kg



4RC60 4-Hole Female Adapter

Article No.	Material	Product Weight	Weight Limit
4RC60S	Stainless Steel	55 g	60 kg
4RC60A	Aluminum	39 g	45 kg



4RC61 Socket Adapter

Article No.	Material	Product Weight	Weight Limit
4RC61	Plastics	54 g	60 kg

Lower Limb for Children

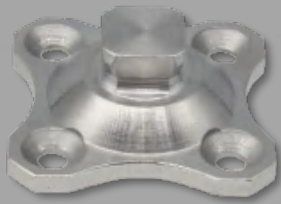

4RC65 4-Hole Pyramid Adapter

Article No.	Material	Product Weight	Weight Limit
4RC65S	Stainless Steel	71 g	60 kg

Knee & Hip Joints



4RC117 3-Arm Rotatable Adapter

Article No.	Material	Product Weight	Weight Limit
4RC117S	Stainless Steel	80 g	60 kg

Modular Feet



4RC118 3-Arm Rotatable Adapter with Pyramid

Article No.	Material	Product Weight	Weight Limit
4RC118S	Stainless Steel	80 g	60 kg

Modular Components

Lock & Liner

Upper Prost.



4RC69 Thermoplastic Socket Adapter

Article No.	Material	Product Weight	Weight Limit
4RC69S	Stainless Steel	140 g	60 kg

Silicon Cosmetic Prost.



4RC66 Tube Clamp Adapter with Pyramid

Article No.	Material	Product Weight	Weight Limit
4RC66S	Stainless Steel	55 g	60 kg
4RC66T	Titanium	36 g	60 kg

Accessories & Materials

Tools

Ortho. Components



4RC110 4-Ear Rotatable Socket Adapter

Article No.	Material	Product Weight	Weight Limit
4RC110S	Stainless Steel	68 g	60 kg

4RC111 4-Ear Female Socket Adapter

Article No.	Material	Product Weight	Weight Limit
4RC111S	Stainless Steel	53 g	60 kg



4RC255 Female Double Adapter

Article No.	Length	Material	Product Weight	Weight Limit
4RC255S-22	22 mm	Stainless Steel	55 g	60 kg
4RC255S-30	30 mm	Stainless Steel	65 g	60 kg
4RC255S-38	38 mm	Stainless Steel	70 g	60 kg



22 mm 30 mm 38 mm

4RC211 Pyramid Double Adapter

Article No.	Length	Material	Product Weight	Weight Limit
4RC211S-22	22 mm	Stainless Steel	55 g	60 kg
4RC211S-30	30 mm	Stainless Steel	65 g	60 kg
4RC211S-38	38 mm	Stainless Steel	70 g	60 kg



22 mm 30 mm 38 mm

4RC76 Short Tube Adapter

Article No.	Length	Material	Product Weight	Weight Limit
4RC76S-38	38 mm	Stainless Steel	49 g	60 kg
4RC76S-46	46 mm	Stainless Steel	56 g	60 kg
4RC76S-54	54 mm	Stainless Steel	65 g	60 kg
4RC76S-62	62 mm	Stainless Steel	71 g	60 kg



38 mm 46 mm



54 mm 62 mm

Knee Joints and Hip Joints

Lower Limb for Children

Knee & Hip Joints

Modular Feet

Modular Components

Lock & Liner

Upper Prost.

Silicon Cosmetic Prost.

Accessories & Materials

Tools

Ortho. Components



2SH1200 Hydraulic Geometric Knee Joint

- Hydraulic 5-axis knee with long steering knuckles that ensure high stability and high flexion angle.
- Dual adjustments of flexion resistance offer better stability performance leading to excellent gait.
- Total height: 180 mm
- Impact level: Medium-High
- Max. flexion: 150°

Article No.	Proximal Connection	Material	Product Weight	Weight Limit
2SH1200	Pyramid	Aluminum	875 g	100 kg



2SH1000 Hydraulic Geometric Knee Joint

*** CAN BE USED FOR THROUGH KNEE PROSTHETICS

- Hydraulic 5-axis knee with long steering knuckles that ensure high stability and high flexion angle.
- Pyramid or lamination anchor available for proximal connection of its suspension geometry
- Total height: 212mm
- Impact level: Low-High
- Max. flexion: 145°

Article No.	Proximal Connection	Material	Product Weight	Weight Limit
2SH1000	Pyramid	Aluminum	1030 g	125 kg
2SH1001	L-Anchor	Aluminum	1050 g	125 kg



2SR500 Pneumatic Knee Joint

- Pneumatic 5-axis knee with long steering knuckles that ensure high stability and high flexion angle.
- Pyramid or thread available for proximal connection of its suspension geometry
- Total height: 210mm
- Max. flexion: 155°
- 5 mm shift in A-P direction on proximal connection surface.

*** CAN BE USED FOR THROUGH KNEE PROSTHETICS

Article No.	Proximal Connection	Material	Product Weight	Weight Limit
2SR500A	Pyramid	Aluminum	948 g	125 kg
2SR500C	36 mm Thread	Aluminum	935 g	125 kg



2SR480 Monocentric Pneumatic Knee Joint
with Weight-activated brake

- Total height: 207mm
- Max. flexion: 135°

Article No.	Proximal Connection	Material	Product Weight	Weight Limit
2SR480	Pyramid	Aluminum	857 g	100 kg



2SR100 Pneumatic Knee Joint

- Adjustable flexion and extension screws
- Total height: 200 mm
- Max. flexion: 140°

Article No.	Proximal Connection	Material	Product Weight	Weight Limit
2SR100	Pyramid	Aluminum	720 g	125 kg



2SR430 Pneumatic Knee Joint

- Three proximal connection modes: pyramid , lamination anchor, and 36 mm thread connection.
- Total height: 200 mm
- Max. flexion: 140°
- There are 0-5 mm shift in A-P direction on proximal connection surface.

*** CAN BE USED FOR THROUGH KNEE PROSTHETICS

Article No.	Proximal Connection	Material	Product Weight	Weight Limit
2SR430A	Pyramid	Aluminum	807 g	125 kg
2SR430B	L-Anchor	Aluminum	930 g	125 kg
2SR430C	36 mm Thread	Aluminum	770 g	125 kg

Lower Limb for Children

Knee & Hip Joints

Modular Feet

Modular Components

Lock & Liner

Upper Prost.

Silicon Cosmetic Prost.

Accessories & Materials

Tools

Ortho. Components



2SR330 Four-bar knee joint

- Total height: 113 mm
- Max. flexion: 165°

Article No.	Proximal Connection	Material	Product	Weight
			Weight	Limit
2SR330	Pyramid	Aluminum	490 g	125 kg



2SR120 Four -Bar Knee Joint with Manual Lock

- The lock mode can be changed to free mode when adjusting two screws.
- Total height: 140 mm
- Max. flexion angle: 140°

Article No.	Proximal Connection	Material	Product	Weight
			Weight	Limit
2SR120	Pyramid	Aluminum	570 g	125 kg



2SR380AM

2SR380B



2SR380C

2SR380 Four-Bar Knee Joint

2SR380M Four-Bar Knee Joint with Manual Lock

- Three proximal connection modes: Pyramid , lamination anchor, and 36mm thread connection.
- Total height: 140 mm
- Max. flexion: 150°
- There are 0-5 mm shift in A-P direction on proximal connection surface.

*** CAN BE USED FOR THROUGH KNEE PROSTHETICS

Article No.	Proximal Connection	Material	Product	Weight
			Weight	Limit
2SR380A	Pyramid	Aluminum	642 g	125 kg
2SR380B	L-Anchor	Aluminum	779 g	125 kg
2SR380C	36 mm Thread	Aluminum	632 g	125 kg
2SR380AM	Pyramid	Aluminum	668 g	125 kg
2SR380BM	L- Anchor	Aluminum	805 g	125 kg
2SR380CM	36 mm Thread	Aluminum	659 g	125 kg



3R40A Monocentric knee Joint with Manual Lock

- Light knee, weight limit: 85 kg
- Height (knee center to upper edge) 35 mm
- Suitable for user who have low activity level
- Build height: 123 mm
- Max. flexion angle: 140°

Article No.	Proximal Connection	Material	Product Weight	Weight Limit
3R40A	Pyramid	Aluminum	300 g	85 kg



2SR350L Polycentric knee Joint with Manual lock

- Max. flexion: 135°
- There are two proximal connection modes available: a pyramid connection, a Lotus adapter for disarticulation use.

Article No.	Proximal connection	Material	Product Weight
2SR350L-P	Pyramid	Aluminum	650 g
2SR350L-KD	Lotus	Aluminum	670 g



3R15 Single Axis Knee Joint

- With weight-activated Brake
- Build height: 40 mm
- Max. flexion angle: 150°

Article No.	Proximal Connection	Material	Product Weight	Weight Limit
3R15S	Pyramid	Stainless Steel	520 g	100 kg
3R15T	Pyramid	Titanium	470 g	100 kg



2SR580 Polycentric Knee Joint with Manual Toggle lock

- With weight-activated Brake
- Build height: 40 mm
-

Article No.	Proximal Connection	Material	Product Weight
2SR480	Pyramid	Aluminum	520 g



21B30 Extension Assist for Knee joint 3R15S /3R15T

- It is used for Knee joint 3R15S/3R15T.

Lower Limb for Children



3R20 Four-bar Knee Joint w/ Pyramid

- Knee flexion angle approx. 120°
- Build height: 135 mm

Article No.	Proximal Connection	Material	Product Weight	Weight Limit
3R20S	Pyramid	Stainless steel	690 g	125 kg
3R20T	Pyramid	Titanium	470 g	125 kg

Knee & Hip Joints

Modular Feet



3R20B Four-bar Knee Joint w/ L-Anchor

- Knee flexion angle approx. 120°
- Build height: 142 mm

Article No.	Proximal Connection	Material	Product Weight	Weight Limit
3R20BS	L-Anchor	Stainless steel	690 g	125 kg

Modular Components

Lock & Liner

Upper Prost.



3R35 Four-bar Knee Joint w/ Pyramid

- Build height: 40 mm
- Max. flexion angle: 150°

Article No.	Proximal Connection	Material	Product Weight	Weight Limit
3R35S	Pyramid	Stainless steel	690 g	125 kg
3R35T	Pyramid	Titanium	470 g	125 kg

Silicon Cosmetic Prost.

Accessories & Materials



3R35B Single Axis Knee Joint w/ L-Anchor

- Knee flexion angle approx. 120° with internal extension assist
- Build height: 125 mm

Article No.	Proximal Connection	Material	Product Weight	Weight Limit
3R35BS	L-Anchor	Stainless steel	710 g	125 kg

Tools

Ortho. Components



3R21 Through Knee Joint w/ L-Anchor

- Knee flexion angle approx. 110°
- Height (knee center to upper edge): 18 mm
- Build height: 128 mm

Article No.	Proximal Connection	Material	Product Weight	Weight Limit
3R21S	L-Anchor	Stainless steel	900 g	125 kg
3R21T	L-Anchor	Titanium	668 g	125 kg



3R23 Through Knee Joint L-Anchor w/ Manual Lock

- Knee flexion angle approx. 110°
- Height (knee center to upper edge): 18 mm
- Build height: 128 mm

Article No.	Proximal Connection	Material	Product Weight	Weight Limit
3R23S	L-Anchor	Stainless steel	900 g	125 kg
3R23T	L-Anchor	Titanium	660 g	125 kg



3R17 Single Axis Knee Joint Pyramid w/ Manual Lock

- Knee flexion angle approx. 120°
- With manual lock and internal extension assist
- Build height: 87 mm

Article No.	Proximal Connection	Material	Product Weight	Weight Limit
3R17S	Pyramid	Stainless steel	565 g	125 kg
3R17T	Pyramid	Titanium	390 g	125 kg



3R22 Single Axis Knee Joint w/ Pyramid

- Knee flexion angle approx. 120°
- With internal extension assist
- Build height: 87 mm

Article No.	Proximal Connection	Material	Product Weight	Weight Limit
3R22S	Pyramid	Stainless steel	540 g	125 kg
3R22T	Pyramid	Titanium	365 g	125 kg

Knee Joints & Hip Joints

Lower Limb for Children
Knee & Hip Joints
Modular Feet
Modular Components
Lock & Liner
Upper Prost.
Silicon Cosmetic Prost.
Accessories & Materials
Tools
Ortho. Components



2SR440 Pneumatic Knee Joint

- Knee flexion angle approx. 140°
- Build height: 200 mm
- There are 0-5 mm shift in A-P direction on proximal connection surface.

Article No.	Proximal Connection	Material	Product Weight	Weight Limit
2SR440A	Pyramid	Aluminum	807 g	125 kg
2SR440B	L- Anchor	Aluminum	930 g	125 kg
2SR440C	36 mm Thread	Aluminum	770 g	125 kg



7SR160 Four-Bar Hip Joint

- Designed for hip disarticulation prosthetics use.

Article No.	Material	Product Weight	Weight Limit
7SR160	Aluminum	820 g	125 kg

* The material of lamination plate is stainless steel.

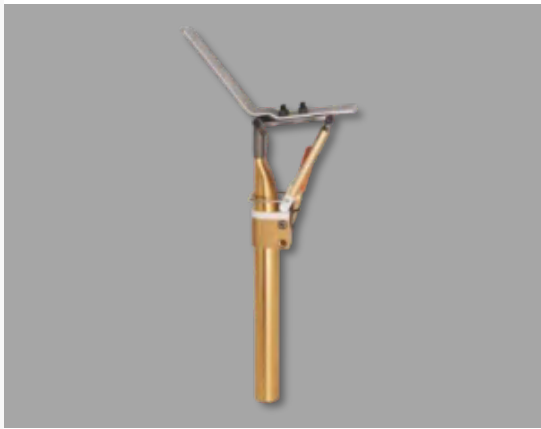

7E5A Single Axis Hip Joint with Manual Lock

- For hip disarticulation and hemipelvectomy amputees with lower functional levels (higher stance phase control).

Article No.	For	Material	Product Weight	Weight Limit
7E5A-L	for Left	Aluminum	895 g	100 kg
7E5A-R	for Right	Aluminum	895 g	100 kg



7E4A Single Axis Hip Joint with Manual Lock

- For hip disarticulation and hemipelvectomy amputees with lower functional levels (moderate stance phase stability, moderate swing phase stability, moderate swing phase control).

Article No.	Material	Product Weight	Weight Limit
7E4A	Aluminum	870 g	100 kg

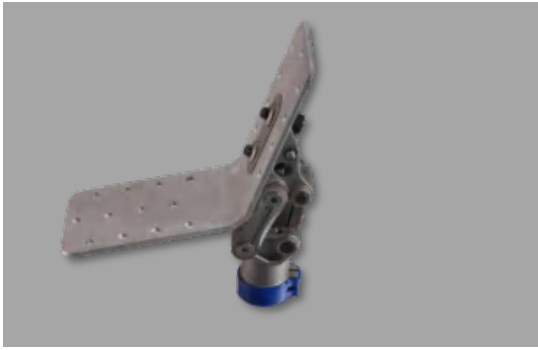

7E8 Four-Bar Hip Joint

- Designed for hip disarticulation prosthetics use.

Article No.	Material	Product	Weight
		Weight	Limit
7E8S	Stainless Steel	830 g	125 kg
7E8T	Titanium	620 g	125 kg



7E7 Single Axis Hip Joint

- Designed for patients who have medium functional levels.
- With internal extension assist

Article No.	Material	Product	Weight
		Weight	Limit
7E7S	Stainless steel	645 g	100 kg
7E7T	Titanium	570 g	100 kg



4R57 Rotation Adapter

- Structure height: 22 mm
- With pyramid for proximal connection and female adjustment adapter for distal connection. Pressing button to un-lock, and you can rotate the adapter. Releasing button, the adapter will be locked automatically.

Article No.	Material	Product
		Weight
4R57S	Stainless steel	255 g
4R57T	Titanium	160 g



4R157 Quick-release Adapter

- There are three proximal connection modes available: a pyramid connection, a Lotus adapter for disarticulation use, and 36mm thread connection.

Article No.	Proximal connection	Material	Product
			Weight
4R157S-A	Pyramid	Stainless Steel	438 g
4R157S-B	Female	Stainless Steel	438 g
4R157S-C	36 mm Thread	Stainless Steel	393 g

Article No.	Proximal connection	Material	Product
			Weight
4R157T-A	Pyramid	Titanium	650 g
4R157T-B	Female	Titanium	930 g
4R157T-C	36 mm Thread	Titanium	770 g

Lower Limb for Children

Knee & Hip Joints

Modular Feet

Modular Components

Lock & Liner

Upper Prost.

Silicon Cosmetic Prost.

Accessories & Materials

Tools

Ortho. Components

Modular Prosthetic Feet

Category Selection Chart					
Weight(kgs)	45-60	61-75	76-90	91-105	106-125
Low Impact Level	1	1	2	3	4
Moderate Impact Level	1	2	3	4	5
High Impact Level	2	3	4	5	NA

1FC40 Low Profile Carbon Foot

- Full-length & split design offers high energy return and superior flexibility.
- The foot enables user to experience natural gait progression.
- Available sizes: 22—29 cm.
- Built height: 68 mm for size of 27 cm
- Foot shell: 1FO foot shell.

	Activity Level			
	1	2	3	4
22 cm	1FC40-22-1	1FC40-22-2	1FC40-22-3	1FC40-22-4
23 cm	1FC40-23-1	1FC40-23-2	1FC40-23-3	1FC40-23-4
24 cm	1FC40-24-1	1FC40-24-2	1FC40-24-3	1FC40-24-4
25 cm	1FC40-25-1	1FC40-25-2	1FC40-25-3	1FC40-25-4
26 cm	1FC40-26-1	1FC40-26-2	1FC40-26-3	1FC40-26-4
27 cm	1FC40-27-1	1FC40-27-2	1FC40-27-3	1FC40-27-4
28 cm	1FC40-28-1	1FC40-28-2	1FC40-28-3	1FC40-28-4
29 cm	1FC40-29-1	1FC40-29-2	1FC40-29-3	1FC40-29-4



1FC45 Carbon Fiber Foot

- Full-length & split design offers stability and comfort while walking.
- The foot enables user to experience natural gait progression.
- Its impact levels are from Low to High which covers many different activities.
- Available sizes: 22—29 cm.
- Built height: 170 mm for size of 27 cm
- Foot shell: 1FO foot shell

	Activity Level			
	1	2	3	4
22 cm	1FC45-22-1	1FC45-22-2	1FC45-22-3	1FC45-22-4
23 cm	1FC45-23-1	1FC45-23-2	1FC45-23-3	1FC45-23-4
24 cm	1FC45-24-1	1FC45-24-2	1FC45-24-3	1FC45-24-4
25 cm	1FC45-25-1	1FC45-25-2	1FC45-25-3	1FC45-25-4
26 cm	1FC45-26-1	1FC45-26-2	1FC45-26-3	1FC45-26-4
27 cm	1FC45-27-1	1FC45-27-2	1FC45-27-3	1FC45-27-4
28 cm	1FC45-28-1	1FC45-28-2	1FC45-28-3	1FC45-28-4
29 cm	1FC45-29-1	1FC45-29-2	1FC45-29-3	1FC45-29-4



Lower Limb for Children

Knee & Hip Joints

Modular Feet

Modular Components

Lock & Liner

Upper Prost.

Silicon Cosmetic Prost.

Accessories & Materials

Tools

Ortho. Components

Category Selection Chart					
Weight(kgs)	45-60	61-75	76-90	91-105	106-125
Low Impact Level	1	1	2	3	4
Moderate Impact Level	1	2	3	4	5
High Impact Level	2	3	4	5	NA



1FC50 Carbon Fiber Foot

- C-shaped carbon fiber lightweight structure ensures stable performance
- Active heel and full-length keel protect the intact limb
- Split-toe design adapts to diverse terrains with lasting comfort
- Balances high reliability and flexible dynamic performance
- Optimizes smooth gait experience for daily walking
- Size range: 22–29 cm
- Built height: 160 mm (for size 27 cm)
- Weight limit: 125kg
- Foot shell: 1FO foot shell

	Activity Level			
	1	2	3	4
22 cm	1FC50-22-1	1FC50-22-2	1FC50-22-3	1FC50-22-4
23 cm	1FC50-23-1	1FC50-23-2	1FC50-23-3	1FC50-23-4
24 cm	1FC50-24-1	1FC50-24-2	1FC50-24-3	1FC50-24-4
25 cm	1FC50-25-1	1FC50-25-2	1FC50-25-3	1FC50-25-4
26 cm	1FC50-26-1	1FC50-26-2	1FC50-26-3	1FC50-26-4
27 cm	1FC50-27-1	1FC50-27-2	1FC50-27-3	1FC50-27-4
28 cm	1FC50-28-1	1FC50-28-2	1FC50-28-3	1FC50-28-4
29 cm	1FC50-29-1	1FC50-29-2	1FC50-29-3	1FC50-29-4

Modular Prosthetic Feet

Lower Limb for Children

Knee & Hip Joints

Modular Feet

Modular Components

Lock & Liner

Upper Prost.

Silicon Cosmetic Prost.

Accessories & Materials

Tools

Ortho. Components

Category Selection Chart					
Weight(kgs)	50-60	61-75	76-90	91-105	106-125
Low Impact Level	1	1	2	3	4
Moderate Impact Level	1	2	3	4	NA
High Impact Level	2	3	4	NA	NA

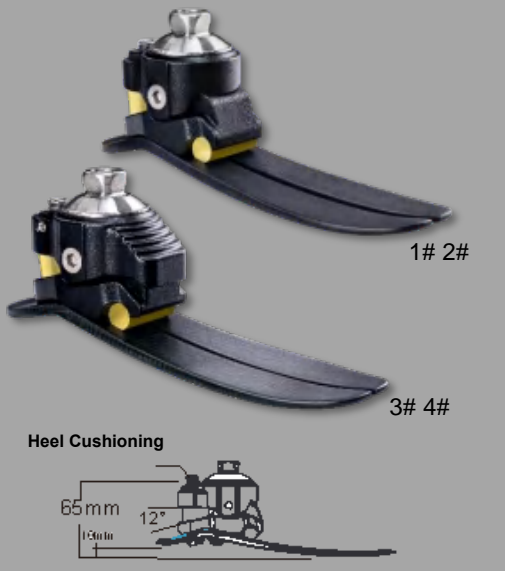

1FC10 Carbon Foot

- Weight limit: 100 kg
- Impact level: Low, Moderate
- Sizes: 22--27cm available

Size	Activity Level			
	1	2	3	4
22 cm	1FC10-S-1	1FC10-S-2	1FC10-S-3	1FC10-S-4
23 cm				
24 cm	1FC10-M-1	1FC10-M-2	1FC10-M-3	1FC10-M-4
25 cm				
26 cm	1FC10-L-1	1FC10-L-2	1FC10-L-3	1FC10-L-4
27 cm				



1FC25 Low Profile Carbon Foot

- Weight limit: 100 kg
- Impact level: Low, Moderate
- Size: 22--27cm available

Size	Activity Level			
	1	2	3	4
22 cm	1FC25-S-1	1FC25-S-2	1FC25-S-3	1FC25-S-4
23 cm				
24 cm	1FC25-M-1	1FC25-M-2	1FC25-M-3	1FC25-M-4
25 cm				
26 cm	1FC25-L-1	1FC25-L-2	1FC25-L-3	1FC25-L-4
27 cm				



1FC65 Carbon Fiber Foot

- Weight limit: 100 kg
- Impact level: Low, Moderate
- Size: 22--27cm available

Size	Activity Level			
	1	2	3	4
22 cm	1FC65-S-1	1FC65-S-2	1FC65-S-3	1FC65-S-4
23 cm				
24 cm	1FC65-M-1	1FC65-M-2	1FC65-M-3	1FC65-M-4
25 cm				
26 cm	1FC65-L-1	1FC65-L-2	1FC65-L-3	1FC65-L-4
27 cm				

Category Selection Chart					
Weight(kgs)	50-60	61-75	76-90	91-105	106-125
Low Impact Level	1	1	2	3	4
Moderate Impact Level	1	2	3	4	NA
High Impact Level	2	3	4	NA	NA



1FC60 Carbon Fiber Foot

- Weight limit: 100 kg
- Impact level: Low, Moderate
- Size: 22--28cm available

Size	Activity Level			
	1	2	3	4
22 cm	1FC60-S-1	1FC60-S-2	1FC60-S-3	1FC60-S-4
23 cm				
24 cm	1FC60-M-1	1FC60-M-2	1FC60-M-3	1FC60-M-4
25 cm				
26 cm	1FC60-L-1	1FC60-L-2	1FC60-L-3	1FC60-L-4
27 cm				
28 cm	1FC60-XL-1	1FC60-XL-2	1FC60-XL-3	1FC60-XL-4



1FC55 Low Profile Carbon Fiber Foot

- Weight limit: 70 kg
- Impact level: Low, Moderate
- Size: 22--27cm available

Size	Activity Level			
	1	2	3	4
22 cm	1FC55-S-1	1FC55-S-2	1FC55-S-3	1FC55-S-4
23 cm				
24 cm	1FC55-M-1	1FC55-M-2	1FC55-M-3	1FC55-M-4
25 cm				
26 cm	1FC55-L-1	1FC55-L-2	1FC55-L-3	1FC55-L-4
27 cm				



1FC70 Carbon Fiber Foot

- Weight limit: 100 kg
- Impact level: Low, Moderate
- Size: 22--27cm available

Size	Activity Level			
	1	2	3	4
22 cm	1FC70-S-1	1FC70-S-2	1FC70-S-3	1FC70-S-4
23 cm				
24 cm	1FC70-M-1	1FC70-M-2	1FC70-M-3	1FC70-M-4
25 cm				
26 cm	1FC70-L-1	1FC70-L-2	1FC70-L-3	1FC70-L-4
27 cm				

Modular Prosthetic Feet

Lower Limb for Children

Knee & Hip Joints

Modular Feet

Modular Components

Lock & Liner

Upper Prosth.

Silicon Cosmetic Prosth.

Accessories & Materials

Tools

Ortho. Components

Category Selection Chart				
Weight(kgs)	50-60	61-75	76-85	86-100
Moderate Impact Level	1	2	3	4
High Impact Level	2	3	4	5



1FC100 Low Profile Carbon Fiber Foot

- Delivers strong ankle power, efficient energy return and smooth rollover for users with longer residual limbs
- Provides greater ankle mobility than traditional low-profile carbon fiber feet
- Lightweight anatomical foot cover with steady-grip sole ensures barefoot stability on slippery surfaces
- Sandal-clamping toe design fits various footwear including flip-flops

	Activity Level				
	1	2	3	4	5
22 cm	1FC100-22-1	1FC100-22-2	1FC100-22-3	1FC100-22-4	1FC100-22-5
23 cm	1FC100-23-1	1FC100-23-2	1FC100-23-3	1FC100-23-4	1FC100-23-5
24 cm	1FC100-24-1	1FC100-24-2	1FC100-24-3	1FC100-24-4	1FC100-24-5
25 cm	1FC100-25-1	1FC100-25-2	1FC100-25-3	1FC100-25-4	1FC100-25-5
26 cm	1FC100-26-1	1FC100-26-2	1FC100-26-3	1FC100-26-4	1FC100-26-5
27 cm	1FC100-27-1	1FC100-27-2	1FC100-27-3	1FC100-27-4	1FC100-27-5
28 cm	1FC100-28-1	1FC100-28-2	1FC100-28-3	1FC100-28-4	1FC100-28-5





1FC200 Carbon Fiber Foot

- Provides strong ankle power, energy return and smooth rollover for long residual limbs
- Enhanced ankle mobility outperforms traditional high-profile feet
- Lightweight ergonomic cover ensures stability on wet surfaces
- Versatile toe fits sandals, flip-flops and more footwear
- Size range: 22–28 cm



















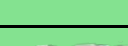

	Activity Level				
	1	2	3	4	5
22 cm	1FC100-22-1	1FC100-22-2	1FC100-22-3	1FC100-22-4	1FC100-22-5
23 cm	1FC100-23-1	1FC100-23-2	1FC100-23-3	1FC100-23-4	1FC100-23-5
24 cm	1FC100-24-1	1FC100-24-2	1FC100-24-3	1FC100-24-4	1FC100-24-5
25 cm	1FC100-25-1	1FC100-25-2	1FC100-25-3	1FC100-25-4	1FC100-25-5
26 cm	1FC100-26-1	1FC100-26-2	1FC100-26-3	1FC100-26-4	1FC100-26-5
27 cm	1FC100-27-1	1FC100-27-2	1FC100-27-3	1FC100-27-4	1FC100-27-5
28 cm	1FC100-28-1	1FC100-28-2	1FC100-28-3	1FC100-28-4	1FC100-28-5

KIT of 1FC40 Carbon Fiber Foot/Foot Shell/Sock

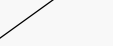
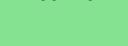

Delivery Content		
Carbon Fiber Foot 1FC40 Series	x1	
Foot shell 1FO2 Series	x1	
Sock of CF Foot 99B10 Series	x1	

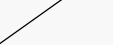
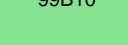
Refer to the Category Selection Chart below to select the model No.

Size	Side	ACTIVITY LEVEL				COMPONENTS				
		1	2	3	4	CF Foot	Sock	Foot Shell		
22		1FC40-22-1	1FC40-22-2	1FC40-22-3	1FC40-22-4					
	Right	1FC40-22R-1	1FC40-22R-2	1FC40-22R-3	1FC40-22R-4				99B10	1FO2 -22R
	Left	1FC40-22L-1	1FC40-22L-2	1FC40-22L-3	1FC40-22L-4				99B10	1FO2 -22L
23		1FC40-23-1	1FC40-23-2	1FC40-23-3	1FC40-23-4					
	Right	1FC40-23R-1	1FC40-23R-2	1FC40-23R-3	1FC40-23R-4				99B10	1FO2 -23R
	Left	1FC40-23L-1	1FC40-23L-2	1FC40-23L-3	1FC40-23L-4				99B10	1FO2 -23L
24		1FC40-24-1	1FC40-24-2	1FC40-24-3	1FC40-24-4					
	Right	1FC40-24R-1	1FC40-24R-2	1FC40-24R-3	1FC40-24R-4				99B10	1FO2 -24R
	Left	1FC40-24L-1	1FC40-24L-2	1FC40-24L-3	1FC40-24L-4				99B10	1FO2 -24L
25		1FC40-25-1	1FC40-25-2	1FC40-25-3	1FC40-25-4					
	Right	1FC40-25R-1	1FC40-25R-2	1FC40-25R-3	1FC40-25R-4				99B10	1FO2 -25R
	Left	1FC40-25L-1	1FC40-25L-2	1FC40-25L-3	1FC40-25L-4				99B10	1FO2 -25L
26		1FC40-26-1	1FC40-26-2	1FC40-26-3	1FC40-26-4					
	Right	1FC40-26R-1	1FC40-26R-2	1FC40-26R-3	1FC40-26R-4				99B10	1FO2 -26R
	Left	1FC40-26L-1	1FC40-26L-2	1FC40-26L-3	1FC40-26L-4				99B10	1FO2 -26L
27		1FC40-27-1	1FC40-27-2	1FC40-27-3	1FC40-27-4					
	Right	1FC40-27R-1	1FC40-27R-2	1FC40-27R-3	1FC40-27R-4				99B10	1FO2 -27R
	Left	1FC40-27L-1	1FC40-27L-2	1FC40-27L-3	1FC40-27L-4				99B10	1FO2 -27L
28		1FC40-28-1	1FC40-28-2	1FC40-28-3	1FC40-28-4					
	Right	1FC40-28R-1	1FC40-28R-2	1FC40-28R-3	1FC40-28R-4				99B10	1FO2 -28R
	Left	1FC40-28L-1	1FC40-28L-2	1FC40-28L-3	1FC40-28L-4				99B10	1FO2 -28L
29		1FC40-29-1	1FC40-29-2	1FC40-29-3	1FC40-29-4					
	Right	1FC40-29R-1	1FC40-29R-2	1FC40-29R-3	1FC40-29R-4				99B10	1FO2 -29R
	Left	1FC40-29L-1	1FC40-29L-2	1FC40-29L-3	1FC40-29L-4				99B10	1FO2 -29L

Lower Limb for Children

Knee & Hip Joints

Modular Feet

Modular Components

Look & Liner

Upper Prost.

Silicon Cosmetic Prost.

Accessories & Materials

Tools

Ortho. Components

Modular Prosthetic Feet

































KIT of 1FC45 Carbon Fiber Foot/Foot Shell/Sock



Delivery Content

Carbon Fiber Foot 1FC45 Series	x1	
Foot shell 1FO Series	x1	
Sock of CF Foot 99B10	x1	

Refer to the Category Selection Chart below to select the model No.

Size	Side	ACTIVITY LEVEL				COMPONENTS		
		1	2	3	4	CF Foot	Sock	Foot Shell
22		1FC45-22-1	1FC45-22-2	1FC45-22-3	1FC45-22-4			
	Right	1FC45-22R-1	1FC45-22R-2	1FC45-22R-3	1FC45-22R-4		99B10	1FO2 -22R
	Left	1FC45-22L-1	1FC45-22L-2	1FC45-22L-3	1FC45-22L-4			1FO2 -22L
23		1FC45-23-1	1FC45-23-2	1FC45-23-3	1FC45-23-4			
	Right	1FC45-23R-1	1FC45-23R-2	1FC45-23R-3	1FC45-23R-4		99B10	1FO2 -23R
	Left	1FC45-23L-1	1FC45-23L-2	1FC45-23L-3	1FC45-23L-4			1FO2 -23L
24		1FC45-24-1	1FC45-24-2	1FC45-24-3	1FC45-24-4			
	Right	1FC45-24R-1	1FC45-24R-2	1FC45-24R-3	1FC45-24R-4		99B10	1FO2 -24R
	Left	1FC45-24L-1	1FC45-24L-2	1FC45-24L-3	1FC45-24L-4			1FO2 -24L
25		1FC45-25-1	1FC45-25-2	1FC45-25-3	1FC45-25-4			
	Right	1FC45-25R-1	1FC45-25R-2	1FC45-25R-3	1FC45-25R-4		99B10	1FO2 -25R
	Left	1FC45-25L-1	1FC45-25L-2	1FC45-25L-3	1FC45-25L-4			1FO2 -25L
26		1FC45-26-1	1FC45-26-2	1FC45-26-3	1FC45-26-4			
	Right	1FC45-26R-1	1FC45-26R-2	1FC45-26R-3	1FC45-26R-4		99B10	1FO2 -26R
	Left	1FC45-26L-1	1FC45-26L-2	1FC45-26L-3	1FC45-26L-4			1FO2 -26L
27		1FC45-27-1	1FC45-27-2	1FC45-27-3	1FC45-27-4			
	Right	1FC45-27R-1	1FC45-27R-2	1FC45-27R-3	1FC45-27R-4		99B10	1FO2 -27R
	Left	1FC45-27L-1	1FC45-27L-2	1FC45-27L-3	1FC45-27L-4			1FO2 -27L
28		1FC45-28-1	1FC45-28-2	1FC45-28-3	1FC45-28-4			
	Right	1FC45-28R-1	1FC45-28R-2	1FC45-28R-3	1FC45-28R-4		99B10	1FO2 -28R
	Left	1FC45-28L-1	1FC45-28L-2	1FC45-28L-3	1FC45-28L-4			1FO2 -28L
29		1FC45-29-1	1FC45-29-2	1FC45-29-3	1FC45-29-4			
	Right	1FC45-29R-1	1FC45-29R-2	1FC45-29R-3	1FC45-29R-4		99B10	1FO2 -29R
	Left	1FC45-29L-1	1FC45-29L-2	1FC45-29L-3	1FC45-29L-4			1FO2 -29L

Lower Limb for Children

Knee & Hip Joints

Modular Feet

Modular Components

Lock & Liner

Upper Prost.

Silicon Cosmetic Prost.

Accessories & Materials



Tools

























Ortho. Components

KIT of 1FC50 Carbon Fiber Foot/Foot Shell/Sock



Delivery Content

Carbon Fiber Foot 1FC50 Series	x1	
Foot shell 1FO Series	x1	
Sock of CF Foot 99B10	x1	

Size	Side	ACTIVITY LEVEL				COMPONENTS				
		1	2	3	4	CF Foot	Sock	Foot Shell		
22		1FC50-22-1	1FC50-22-2	1FC50-22-3	1FC50-22-4					
	Right	1FC50-22R-1	1FC50-22R-2	1FC50-22R-3	1FC50-22R-4				99B10	1FO2 -22R
	Left	1FC50-22L-1	1FC50-22L-2	1FC50-22L-3	1FC50-22L-4					1FO2 -22L
23		1FC50-23-1	1FC50-23-2	1FC50-23-3	1FC50-23-4					
	Right	1FC50-23R-1	1FC50-23R-2	1FC50-23R-3	1FC50-23R-4				99B10	1FO2 -23R
	Left	1FC50-23L-1	1FC50-23L-2	1FC50-23L-3	1FC50-23L-4					1FO2 -23L
24		1FC50-24-1	1FC50-24-2	1FC50-24-3	1FC50-24-4					
	Right	1FC50-24R-1	1FC50-24R-2	1FC50-24R-3	1FC50-24R-4				99B10	1FO2 -24R
	Left	1FC50-24L-1	1FC50-24L-2	1FC50-24L-3	1FC50-24L-4					1FO2 -24L
25		1FC50-25-1	1FC50-25-2	1FC50-25-3	1FC50-25-4					
	Right	1FC50-25R-1	1FC50-25R-2	1FC50-25R-3	1FC50-25R-4				99B10	1FO2 -25R
	Left	1FC50-25L-1	1FC50-25L-2	1FC50-25L-3	1FC50-25L-4					1FO2 -25L
26		1FC50-26-1	1FC50-26-2	1FC50-26-3	1FC50-26-4					
	Right	1FC50-26R-1	1FC50-26R-2	1FC50-26R-3	1FC50-26R-4				99B10	1FO2 -26R
	Left	1FC50-26L-1	1FC50-26L-2	1FC50-26L-3	1FC50-26L-4					1FO2 -26L
27		1FC50-27-1	1FC50-27-2	1FC50-27-3	1FC50-27-4					
	Right	1FC50-27R-1	1FC50-27R-2	1FC50-27R-3	1FC50-27R-4				99B10	1FO2 -27R
	Left	1FC50-27L-1	1FC50-27L-2	1FC50-27L-3	1FC50-27L-4					1FO2 -27L
28		1FC50-28-1	1FC50-28-2	1FC50-28-3	1FC50-28-4					
	Right	1FC50-28R-1	1FC50-28R-2	1FC50-28R-3	1FC50-28R-4				99B10	1FO2 -28R
	Left	1FC50-28L-1	1FC50-28L-2	1FC50-28L-3	1FC50-28L-4					1FO2 -28L
29		1FC50-29-1	1FC50-29-2	1FC50-29-3	1FC50-29-4					
	Right	1FC50-29R-1	1FC50-29R-2	1FC50-29R-3	1FC50-29R-4				99B10	1FO2 -29R
	Left	1FC50-29L-1	1FC50-29L-2	1FC50-29L-3	1FC50-29L-4					1FO2 -29L

Lower Limb for Children

Knee & Hip Joints

Modular Feet

Modular Components

Look & Liner

Upper Prost.

Silicon Cosmetic Prost.

Accessories & Materials

Tools

Ortho. Components

Modular Prosthetic Feet

Lower Limb for Children

Knee & Hip Joints

Modular Feet

Modular Components

Lock & Liner

Upper Prost.

Silicon Cosmetic Prost.

Accessories & Materials

Tools

Ortho. Components

KIT of 1FC10 Carbon Fiber Foot/Foot Shell/Sock

ACTIVITY LEVEL:1, 2





















ACTIVITY LEVEL:3, 4



Delivery Content

Carbon Fiber Foot 1FC10 Series	x1	
Foot shell 1FX2 Series	x1	
Sock of CF Foot 99B10	x1	

Refer to the Category Selection Chart below to select the model No.

Size	Side	ACTIVITY LEVEL				COMPONENTS		
		1	2	3	4	CF Foot	Sock	Foot Shell
22		1FC10-S-1	1FC10-S-2	1FC10-S-3	1FC10-S-4			
	Right	1FC10-22R-1	1FC10-22R-2	1FC10-22R-3	1FC10-22R-4			
	Left	1FC10-22L-1	1FC10-22L-2	1FC10-22L-3	1FC10-22L-4			
23		1FC10-S-1	1FC10-S-2	1FC10-S-3	1FC10-S-4			
	Right	1FC10-23R-1	1FC10-23R-2	1FC10-23R-3	1FC10-23R-4			
	Left	1FC10-23L-1	1FC10-23L-2	1FC10-23L-3	1FC10-23L-4			
24		1FC10-M-1	1FC10-M-2	1FC10-M-3	1FC10-M-4			
	Right	1FC10-24R-1	1FC10-24R-2	1FC10-24R-3	1FC10-24R-4			
	Left	1FC10-24L-1	1FC10-24L-2	1FC10-24L-3	1FC10-24L-4			
25		1FC10-M-1	1FC10-M-2	1FC10-M-3	1FC10-M-4			
	Right	1FC10-25R-1	1FC10-25R-2	1FC10-25R-3	1FC10-25R-4			
	Left	1FC10-25L-1	1FC10-25L-2	1FC10-25L-3	1FC10-25L-4			
26		1FC10-L-1	1FC10-L-2	1FC10-L-3	1FC10-L-4			
	Right	1FC10-26R-1	1FC10-26R-2	1FC10-26R-3	1FC10-26R-4			
	Left	1FC10-26L-1	1FC10-26L-2	1FC10-26L-3	1FC10-26L-4			
27		1FC10-L-1	1FC10-L-2	1FC10-L-3	1FC10-L-4			
	Right	1FC10-27R-1	1FC10-27R-2	1FC10-27R-3	1FC10-27R-4			
	Left	1FC10-27L-1	1FC10-27L-2	1FC10-27L-3	1FC10-27L-4			

























KIT of 1FC25 Carbon Fiber Foot/Foot Shell/Sock



Delivery Content

Carbon Fiber Foot 1FC25 Series	x1	
Foot shell 1FX2 Series	x1	
Sock of CF Foot 99B10	x1	

Refer to the Category Selection Chart below to select the model No.

Size	Side	ACTIVITY LEVEL				COMPONENTS		
		1	2	3	4	CF Foot	Sock	Foot Shell
22		1FC25-S-1	1FC25-S-2	1FC25-S-3	1FC25-S-4			
	Right	1FC25-22R-1	1FC25-22R-2	1FC25-22R-3	1FC25-22R-4		99B10	1FX2-22
	Left	1FC25-22L-1	1FC25-22L-2	1FC25-22L-3	1FC25-22L-4			1FX2-22
23		1FC25-S-1	1FC25-S-2	1FC25-S-3	1FC25-S-4			
	Right	1FC25-23R-1	1FC25-23R-2	1FC25-23R-3	1FC25-23R-4		99B10	1FX2-23
	Left	1FC25-23L-1	1FC25-23L-2	1FC25-23L-3	1FC25-23L-4			1FX2-23
24		1FC25-M-1	1FC25-M-2	1FC25-M-3	1FC25-M-4			
	Right	1FC25-24R-1	1FC25-24R-2	1FC25-24R-3	1FC25-24R-4		99B10	1FX2-24
	Left	1FC25-24L-1	1FC25-24L-2	1FC25-24L-3	1FC25-24L-4			1FX2-24
25		1FC25-M-1	1FC25-M-2	1FC25-M-3	1FC25-M-4			
	Right	1FC25-25R-1	1FC25-25R-2	1FC25-25R-3	1FC25-25R-4		99B10	1FX2-25
	Left	1FC25-25L-1	1FC25-25L-2	1FC25-25L-3	1FC25-25L-4			1FX2-25
26		1FC25-L-1	1FC25-L-2	1FC25-L-3	1FC25-L-4			
	Right	1FC25-26R-1	1FC25-26R-2	1FC25-26R-3	1FC25-26R-4		99B10	1FX2-26
	Left	1FC25-26L-1	1FC25-26L-2	1FC25-26L-3	1FC25-26L-4			1FX2-26
27		1FC25-L-1	1FC25-L-2	1FC25-L-3	1FC25-L-4			
	Right	1FC25-27R-1	1FC25-27R-2	1FC25-27R-3	1FC25-27R-4		99B10	1FX2-27
	Left	1FC25-27L-1	1FC25-27L-2	1FC25-27L-3	1FC25-27L-4			1FX2-27

Modular Prosthetic Feet

KIT of 1FC65 Carbon Fiber Foot/Foot Shell/Sock

Lower Limb for Children

Knee & Hip Joints

Modular Feet

Modular Components

Lock & Liner

Upper Prost.

Silicon Cosmetic Prost.

Accessories & Materials

Tools

Ortho. Components



Delivery Content

Carbon Fiber Foot 1FC65 Series	x1	
Foot shell 1FX2 Series	x1	
Sock of CF Foot 99B10	x1	

Refer to the Category Selection Chart below to select the model No.

Size	Side	ACTIVITY LEVEL				COMPONENTS		
		1	2	3	4	CF Foot	Sock	Foot Shell
22		1FC65-S-1	1FC65-S-2	1FC65-S-3	1FC65-S-4			
	Right	1FC65-22R-1	1FC65-22R-2	1FC65-22R-3	1FC65-22R-4		99B10	1FX2-22
	Left	1FC65-22L-1	1FC65-22L-2	1FC65-22L-3	1FC65-22L-4			1FX2-22
23		1FC65-S-1	1FC65-S-2	1FC65-S-3	1FC65-S-4			
	Right	1FC65-23R-1	1FC65-23R-2	1FC65-23R-3	1FC65-23R-4		99B10	1FX2-23
	Left	1FC65-23L-1	1FC65-23L-2	1FC65-23L-3	1FC65-23L-4			1FX2-23
24		1FC65-M-1	1FC65-M-2	1FC65-M-3	1FC65-M-4			
	Right	1FC65-24R-1	1FC65-24R-2	1FC65-24R-3	1FC65-24R-4		99B10	1FX2-24
	Left	1FC65-24L-1	1FC65-24L-2	1FC65-24L-3	1FC65-24L-4			1FX2-24
25		1FC65-M-1	1FC65-M-2	1FC65-M-3	1FC65-M-4			
	Right	1FC65-25R-1	1FC65-25R-2	1FC65-25R-3	1FC65-25R-4		99B10	1FX2-25
	Left	1FC65-25L-1	1FC65-25L-2	1FC65-25L-3	1FC65-25L-4			1FX2-25
26		1FC65-L-1	1FC65-L-2	1FC65-L-3	1FC65-L-4			
	Right	1FC65-26R-1	1FC65-26R-2	1FC65-26R-3	1FC65-26R-4		99B10	1FX2-26
	Left	1FC65-26L-1	1FC65-26L-2	1FC65-26L-3	1FC65-26L-4			1FX2-26
27		1FC65-L-1	1FC65-L-2	1FC65-L-3	1FC65-L-4			
	Right	1FC65-27R-1	1FC65-27R-2	1FC65-27R-3	1FC65-27R-4		99B10	1FX2-27
	Left	1FC65-27L-1	1FC65-27L-2	1FC65-27L-3	1FC65-27L-4			1FX2-27

















KIT of 1FC60 Carbon Fiber Foot/Foot Shell/Sock

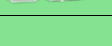

Delivery Content

Carbon Fiber Foot 1FC60 Series	x1	
Foot shell 1FX2 Series	x1	
Sock of CF Foot 99B10	x1	

Refer to the Category Selection Chart below to select the model No.

Size	Side	ACTIVITY LEVEL				COMPONENTS		
		1	2	3	4	CF Foot	Sock	Foot Shell
22		1FC60-S-1	1FC60-S-2	1FC60-S-3	1FC60-S-4			
	Right	1FC60-22R-1	1FC60-22R-2	1FC60-22R-3	1FC60-22R-4	/	99B10	1FX2-22
	Left	1FC60-22L-1	1FC60-22L-2	1FC60-22L-3	1FC60-22L-4			1FX2-22
23		1FC60-S-1	1FC60-S-2	1FC60-S-3	1FC60-S-4			
	Right	1FC60-23R-1	1FC60-23R-2	1FC60-23R-3	1FC60-23R-4	/	99B10	1FX2-23
	Left	1FC60-23L-1	1FC60-23L-2	1FC60-23L-3	1FC60-23L-4			1FX2-23
24		1FC60-M-1	1FC60-M-2	1FC60-M-3	1FC60-M-4			
	Right	1FC60-24R-1	1FC60-24R-2	1FC60-24R-3	1FC60-24R-4	/	99B10	1FX2-24
	Left	1FC60-24L-1	1FC60-24L-2	1FC60-24L-3	1FC60-24L-4			1FX2-24
25		1FC60-M-1	1FC60-M-2	1FC60-M-3	1FC60-M-4			
	Right	1FC60-25R-1	1FC60-25R-2	1FC60-25R-3	1FC60-25R-4	/	99B10	1FX2-25
	Left	1FC60-25L-1	1FC60-25L-2	1FC60-25L-3	1FC60-25L-4			1FX2-25
26		1FC60-L-1	1FC60-L-2	1FC60-L-3	1FC60-L-4			
	Right	1FC60-26R-1	1FC60-26R-2	1FC60-26R-3	1FC60-26R-4	/	99B10	1FX2-26
	Left	1FC60-26L-1	1FC60-26L-2	1FC60-26L-3	1FC60-26L-4			1FX2-26
27		1FC60-L-1	1FC60-L-2	1FC60-L-3	1FC60-L-4			
	Right	1FC60-27R-1	1FC60-27R-2	1FC60-27R-3	1FC60-27R-4	/	99B10	1FX2-27
	Left	1FC60-27L-1	1FC60-27L-2	1FC60-27L-3	1FC60-27L-4			1FX2-27

Lower Limb for Children

Knee & Hip Joints

Modular Feet

Modular Components

Look & Liner

Upper Prost.

Silicon Cosmetic Prost.

Accessories & Materials

Tools

Ortho. Components

Modular Prosthetic Feet

KIT of 1FC55 Carbon Fiber Foot/Foot Shell/Sock

Lower Limb for Children

Knee & Hip Joints

Modular Feet

Modular Components

Lock & Liner

Upper Prost.

Silicon Cosmetic Prost.

Accessories & Materials

Tools



Ortho. Components



Delivery Content

Carbon Fiber Foot 1FC55 Series	x1	
Foot shell 1FN2 Series	x1	
Sock of CF Foot 99B10	x1	

Refer to the Category Selection Chart below to select the model No.

Size	Side	ACTIVITY LEVEL				COMPONENTS		
		1	2	3	4	CF Foot	Sock	Foot Shell
22		1FC55-S-1	1FC55-S-2	1FC55-S-3	1FC55-S-4			
	Right	1FC55-22R-1	1FC55-22R-2	1FC55-22R-3	1FC55-22R-4	/	99B10	1FN2-22
	Left	1FC55-22L-1	1FC55-22L-2	1FC55-22L-3	1FC55-22L-4			1FN2-22
23		1FC55-S-1	1FC55-S-2	1FC55-S-3	1FC55-S-4			
	Right	1FC55-23R-1	1FC55-23R-2	1FC55-23R-3	1FC55-23R-4	/	99B10	1FN2-23
	Left	1FC55-23L-1	1FC55-23L-2	1FC55-23L-3	1FC55-23L-4			1FN2-23
24		1FC55-M-1	1FC55-M-2	1FC55-M-3	1FC55-M-4			
	Right	1FC55-24R-1	1FC55-24R-2	1FC55-24R-3	1FC55-24R-4	/	99B10	1FN2-24
	Left	1FC55-24L-1	1FC55-24L-2	1FC55-24L-3	1FC55-24L-4			1FN2-24
25		1FC55-M-1	1FC55-M-2	1FC55-M-3	1FC55-M-4			
	Right	1FC55-25R-1	1FC55-25R-2	1FC55-25R-3	1FC55-25R-4	/	99B10	1FN2-25
	Left	1FC55-25L-1	1FC55-25L-2	1FC55-25L-3	1FC55-25L-4			1FN2-25
26		1FC55-L-1	1FC55-L-2	1FC55-L-3	1FC55-L-4			
	Right	1FC55-26R-1	1FC55-26R-2	1FC55-26R-3	1FC55-26R-4	/	99B10	1FN2-26
	Left	1FC55-26L-1	1FC55-26L-2	1FC55-26L-3	1FC55-26L-4			1FN2-26
27		1FC55-L-1	1FC55-L-2	1FC55-L-3	1FC55-L-4			
	Right	1FC55-27R-1	1FC55-27R-2	1FC55-27R-3	1FC55-27R-4	/	99B10	1FN2-27
	Left	1FC55-27L-1	1FC55-27L-2	1FC55-27L-3	1FC55-27L-4			1FN2-27











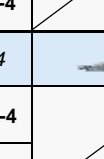



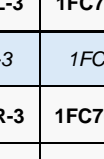



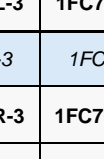

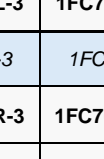

KIT of 1FC70 Carbon Fiber Foot/Foot Shell/Sock

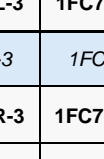

Delivery Content

Carbon Fiber Foot 1FC70 Series	x1	
Foot shell 1FN2 Series	x1	
Sock of CF Foot 99B10	x1	

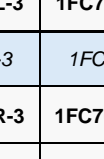
Refer to the Category Selection Chart below to select the model No.

Size	Side	ACTIVITY LEVEL				COMPONENTS		
		1	2	3	4	CF Foot	Sock	Foot Shell
22		1FC70-S-1	1FC70-S-2	1FC70-S-3	1FC70-S-4			
	Right	1FC70-22R-1	1FC70-22R-2	1FC70-22R-3	1FC70-22R-4		99B10	1FN2-22
	Left	1FC70-22L-1	1FC70-22L-2	1FC70-22L-3	1FC70-22L-4			1FN2-22
23		1FC70-S-1	1FC70-S-2	1FC70-S-3	1FC70-S-4			
	Right	1FC70-23R-1	1FC70-23R-2	1FC70-23R-3	1FC70-23R-4		99B10	1FN2-23
	Left	1FC70-23L-1	1FC70-23L-2	1FC70-23L-3	1FC70-23L-4			1FN2-23
24		1FC70-M-1	1FC70-M-2	1FC70-M-3	1FC70-M-4			
	Right	1FC70-24R-1	1FC70-24R-2	1FC70-24R-3	1FC70-24R-4		99B10	1FN2-24
	Left	1FC70-24L-1	1FC70-24L-2	1FC70-24L-3	1FC70-24L-4			1FN2-24
25		1FC70-M-1	1FC70-M-2	1FC70-M-3	1FC70-M-4			
	Right	1FC70-25R-1	1FC70-25R-2	1FC70-25R-3	1FC70-25R-4		99B10	1FN2-25
	Left	1FC70-25L-1	1FC70-25L-2	1FC70-25L-3	1FC70-25L-4			1FN2-25
26		1FC70-L-1	1FC70-L-2	1FC70-L-3	1FC70-L-4			
	Right	1FC70-26R-1	1FC70-26R-2	1FC70-26R-3	1FC70-26R-4		99B10	1FN2-26
	Left	1FC70-26L-1	1FC70-26L-2	1FC70-26L-3	1FC70-26L-4			1FN2-26
27		1FC70-L-1	1FC70-L-2	1FC70-L-3	1FC70-L-4			
	Right	1FC70-27R-1	1FC70-27R-2	1FC70-27R-3	1FC70-27R-4		99B10	1FN2-27
	Left	1FC70-27L-1	1FC70-27L-2	1FC70-27L-3	1FC70-27L-4			1FN2-27

Lower Limb for Children
Knee & Hip Joints
Modular Feet
Modular Components
Look & Liner
Upper Prost.
Silicon Cosmetic Prost.
Accessories & Materials
Tools
Ortho. Components

Modular Prosthetic Feet

KIT of 1FC100 Low Profile Carbon Fiber Foot

A good level of ankle power, energy return and overall dynamics has often eluded people with longer residual limbs. 1FC100 has been specially designed to counter those issues and to provide smooth rollover.



The products offer a high degree of ankle motion and significant improvement on conventional low profile carbon fiber feet.

The well-designed and lightweight anatomical foot cover features a steady-grip sole for barefoot stability on wet or slick surfaces and a sandal-clamping toe for a range of footwear including flipflops.



User Information	
Amputation level	Transfemoral and Transtibial
Impact Level	Moderate to High
Maximum Patient Weight	100kg

Foot Information	
Categories:	1-5
Size:	22-28cm
Weight of Foot: size 25	409g
Adapter Options:	Male Pyramid

Delivery Content	Qty	Picture
Carbon Fiber Foot	X1	
Foot Shell	X1	
Sock of CF Foot	X1	



Activity Level \ Weight kg	45-60	61-75	76-85	86-100
	Moderate	1	2	3
High	2	3	4	5

	1	2	3	4	5
22					
23					
24					
25					
26					
27					
28					

KIT of 1FC200 High Profile Carbon Fiber Foot

The 1FC200 high-profile carbon fiber foot is engineered to give users with longer residual limbs the ankle power, energy return and dynamic gait they need, enabling effortless, smooth rollover.

With enhanced ankle mobility that exceeds traditional high-profile designs, it delivers reliable performance for daily use. The lightweight, ergonomic foot cover features a steady-grip sole for wet-surface stability and a versatile toe design that works with sandals, flip-flops and more.



User Information	
Amputation level	Transfemoral and Transtibial
Impact Level	Moderate to High
Maximum Patient Weight	100kg

Foot Information	
Categories:	1-5
Size:	22-28cm
Weight of Foot: size 25	495g
Adapter Options:	Male Pyramid

Delivery Content	Qty	Picture
Carbon Fiber Foot	X1	
Foot Shell	X1	
Sock of CF Foot	X1	



Activity Level \ Weight kg	45-60	61-75	76-85	86-100
	Moderate	1	2	3
High	2	3	4	5

	1	2	3	4	5
22					
23					
24					
25					
26					
27					
28					

- Lower Limb for Children
- Knee & Hip Joints
- Modular Feet
- Modular Components
- Look & Liner
- Upper Prost.
- Silicon Cosmetic Prost.
- Accessories & Materials
- Tools
- Ortho. Components

Modular Prosthetic Feet

Lower Limb for Children

Knee & Hip Joints

Modular Feet

Modular Components

Lock & Liner

Upper Prost.

Silicon Cosmetic Prost.

Accessories & Materials

Tools

Ortho. Components



1FS Carbon Fiber Foot (Pyramid)

Article No.	Sizes	Adaptive Foot	Product weight	Weight limit
1FS201	Small	22-23cm	243 g	50 kg
1FS301	Small	22-23cm	243 g	70 kg
1FS401	Small	22-23cm	243 g	90 kg
1FS601	Medium	24-25 cm	267 g	50 kg
1FS701	Medium	24-25 cm	267 g	70 kg
1FS901	Medium	24-25 cm	267 g	90 kg
1FS102	Large	26-28 cm	290 g	70 kg
1FS802	Large	26-28 cm	290 g	90 kg



1FM Carbon Fiber Foot (Syme)

Article No.	Sizes	Adaptive Foot	Product weight	Weight limit
1FM201	Small	22-23cm	185 g	50 kg
1FM301	Small	22-23cm	185 g	70 kg
1FM401	Small	22-23cm	185 g	90 kg
1FM601	Medium	24-25 cm	209 g	50 kg
1FM701	Medium	24-25 cm	209 g	70 kg
1FM901	Medium	24-25 cm	209 g	90 kg
1FM102	Large	26-28 cm	232 g	70 kg
1FM802	Large	26-28 cm	232 g	90 kg



2R44 Syme Lamination Support

Article No.	Base Φ	Material	Product weight	Weight limit
2R4421	Φ 62 mm	Titanium	145 g	120 kg
2R4431	Φ 74 mm	Titanium	190 g	120 kg



1N01 Foot Shell

Article No.	Size	Side	Toes	Heel	
				Weight Limit	Height
1N01-22R	22 cm	right	Non Toe-Split	100 kg	10 mm
1N01-22L	22 cm	left	Non Toe-Split	100 kg	10 mm
1N01-23R	23 cm	right	Non Toe-Split	100 kg	10 mm
1N01-23L	23 cm	left	Non Toe-Split	100 kg	10 mm
1N01-24R	24 cm	right	Non Toe-Split	100 kg	10 mm
1N01-24L	24 cm	left	Non Toe-Split	100 kg	10 mm
1N01-25R	25 cm	right	Non Toe-Split	100 kg	10 mm
1N01-25L	25 cm	left	Non Toe-Split	100 kg	10 mm
1N01-26R	26 cm	right	Non Toe-Split	100 kg	10 mm
1N01-26L	26 cm	left	Non Toe-Split	100 kg	10 mm
1N01-27R	27 cm	right	Non Toe-Split	100 kg	10 mm
1N01-27L	27 cm	left	Non Toe-Split	100 kg	10 mm
1N01-28R	28 cm	right	Non Toe-Split	100 kg	10 mm
1N01-28L	28 cm	left	Non Toe-Split	100 kg	10 mm



1N4200 Quantum Foot Shell, Toe-split

1N3200 Quantum Foot Shell, Non Toe-split

Article No.	Size	Side	Toe-Split	Heel	
				Weight Limit	Height
1N4200-24R	24 cm	right	Yes	100 kg	10 mm
1N4200-24L	24 cm	left	Yes	100 kg	10 mm
1N4200-25R	25 cm	right	Yes	100 kg	10 mm
1N4200-25L	25 cm	left	Yes	100 kg	10 mm
1N4200-26R	26 cm	right	Yes	100 kg	10 mm
1N4200-26L	26 cm	left	Yes	100 kg	10 mm
1N4200-27R	27 cm	right	Yes	100 kg	10 mm
1N4200-27L	27 cm	left	Yes	100 kg	10 mm
1N4200-28R	28 cm	right	Yes	100 kg	10 mm
1N4200-28L	28 cm	left	Yes	100 kg	10 mm
1N4200-29R	29 cm	right	Yes	100 kg	10 mm
1N4200-29L	29 cm	left	Yes	100 kg	10 mm
1N4200-30R	30 cm	right	Yes	100 kg	10 mm
1N4200-30L	30 cm	left	Yes	100 kg	10 mm

Article No.	Size	Side	Toe-Split	Heel	
				Weight Limit	Height
1N3200-22R	22 cm	right	No	100 kg	10 mm
1N3200-22L	22 cm	left	No	100 kg	10 mm
1N3200-23R	23 cm	right	No	100 kg	10 mm
1N3200-23L	23 cm	left	No	100 kg	10 mm
1N3200-24R	24 cm	right	No	100 kg	10 mm
1N3200-24L	24 cm	left	No	100 kg	10 mm
1N3200-25R	25 cm	right	No	100 kg	10 mm
1N3200-25L	25 cm	left	No	100 kg	10 mm
1N3200-26R	26 cm	right	No	100 kg	10 mm
1N3200-26L	26 cm	left	No	100 kg	10 mm
1N3200-27R	27 cm	right	No	100 kg	10 mm
1N3200-27L	27 cm	left	No	100 kg	10 mm

Modular Prosthetic Feet

Lower Limb for Children

Knee & Hip Joints

Modular Feet

Modular Components

Lock & Liner

Upper Prost.

Silicon Cosmetic Prost.

Accessories & Materials

Tools

Ortho. Components



1E20 Dynamic Foot

- Rib core provides energy-return performance.
- The hardness of heel wedge can be adjusted by a screw on ankle surface

Article No.	Size	Side	Weight Limit	Heel Height
1E20-21R	21 cm	right	125 kg	10 mm
1E20-21L	21 cm	left	125 kg	10 mm
1E20-22R	22 cm	right	125 kg	10 mm
1E20-22L	22 cm	left	125 kg	10 mm
1E20-23R	23 cm	right	125 kg	10 mm
1E20-23L	23 cm	left	125 kg	10 mm
1E20-24R	24 cm	right	125 kg	10 mm
1E20-24L	24 cm	left	125 kg	10 mm
1E20-25R	25 cm	right	125 kg	10 mm
1E20-25L	25 cm	left	125 kg	10 mm
1E20-26R	26 cm	right	125 kg	10 mm
1E20-26L	26 cm	left	125 kg	10 mm
1E20-27R	27 cm	right	125 kg	10 mm
1E20-27L	27 cm	left	125 kg	10 mm
1E20-28R	28 cm	right	125 kg	10 mm
1E20-28L	28 cm	left	125 kg	10 mm
1E20-29R	29 cm	right	125 kg	10 mm
1E20-29L	29 cm	left	125 kg	10 mm

NEW



1E25 Dynamic Foot

- Reliable dynamic prosthetic featuring an integrated S-shaped spring design.
- Provides smooth roll-overs, effective energy return, and stable performance on uneven terrain.
- Designed for users seeking natural gait dynamics at a highly competitive price, the 1E25 delivers excellent value without compromising daily mobility and comfort.

Key Advantages:

- ✓ Integrated S-shaped spring for dynamic response
- ✓ Smooth and physiological roll-over
- ✓ Energy return to support efficient gait
- ✓ Compensation for uneven terrain
- ✓ Cost-effective alternative to premium dynamic feet

Article No.	Size	Side	Weight Limit	Heel Height
1E25-21R	21 cm	right	125 kg	10 mm
1E25-21L	21 cm	left	125 kg	10 mm
1E25-22R	22 cm	right	125 kg	10 mm
1E25-22L	22 cm	left	125 kg	10 mm
1E25-23R	23 cm	right	125 kg	10 mm
1E25-23L	23 cm	left	125 kg	10 mm
1E25-24R	24 cm	right	125 kg	10 mm
1E25-24L	24 cm	left	125 kg	10 mm
1E25-25R	25 cm	right	125 kg	10 mm
1E25-25L	25 cm	left	125 kg	10 mm
1E25-26R	26 cm	right	125 kg	10 mm
1E25-26L	26 cm	left	125 kg	10 mm
1E25-27R	27 cm	right	125 kg	10 mm
1E25-27L	27 cm	left	125 kg	10 mm
1E25-28R	28 cm	right	125 kg	10 mm
1E25-28L	28 cm	left	125 kg	10 mm
1E25-29R	29 cm	right	125 kg	10 mm
1E25-29L	29 cm	left	125 kg	10 mm



1N05W SACH Foot w/ Toe Split

- Colors: Standard Caucasian color; the brown option has the suffix "BR"
- Heel Height 10 mm, Foot of polyurethane, Core made of wood with bushing. Forefoot is flat-convex

Article No.	Size	Side	Weight Limit	Heel Height
1N05W- 20R	20 cm	right	125 kg	10 mm
1N05W-20L	20 cm	left	125 kg	10 mm
1N05W-21R	21 cm	right	125 kg	10 mm
1N05W-21L	21 cm	left	125 kg	10 mm
1N05W-22R	22 cm	right	125 kg	10 mm
1N05W-22L	22 cm	left	125 kg	10 mm
1N05W-23R	23 cm	right	125 kg	10 mm
1N05W-23L	23 cm	left	125 kg	10 mm
1N05W-24R	24 cm	right	125 kg	10 mm
1N05W-24L	24 cm	left	125 kg	10 mm
1N05W-25R	25 cm	right	125 kg	10 mm
1N05W-25L	25 cm	left	125 kg	10 mm
1N05W-26R	26 cm	right	125 kg	10 mm
1N05W-26L	26 cm	left	125 kg	10 mm
1N05W-27R	27 cm	right	125 kg	10 mm
1N05W-27L	27 cm	left	125 kg	10 mm
1N05W-28R	28 cm	right	125 kg	10 mm
1N05W-28L	28 cm	left	125 kg	10 mm
1N05W-29R	29 cm	right	125 kg	10 mm
1N05W-29L	29 cm	left	125 kg	10 mm
1N05W-30R	30 cm	right	125 kg	10 mm
1N05W-30L	30 cm	left	125 kg	10 mm



2N1 Foot Adapter

- Completed with bolted connection

Article No.	2-pins	Material	Product weight	Weight limit
2N1S	No pins	Stainless Steel	110 g	125 kg
2N1T	No pins	Titanium	86 g	125 kg



2N1-1 Foot Adapter w/ 2 Pins

- Completed with bolted connection

Article No.	2-pins	Material	Product weight	Weight limit
2N1S-1	2-pins	Stainless Steel	112 g	125 kg
2N1T-1	2-pins	Titanium	88 g	125 kg

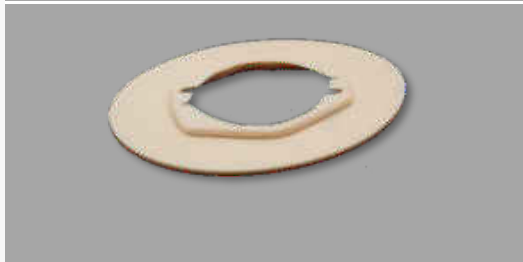

2R14 Foot Connection Plate for SACH Foot

- Made of plastic.
- To be bonded to cosmetic soft foam cover and snapped onto 20-30 SACH Foot Adapter

Modular Prosthetic Feet

Lower Limb for Children

Knee & Hip Joints

Modular Feet

Modular Components

Lock & Liner

Upper Prost.

Silicon Cosmetic Prost.

Accessories & Materials

Tools

Ortho. Components



1S03W Two Hole Single Axis Foot

- Colors: Standard Caucasian color; the brown option has the suffix "BR"

Article No.	Size	Side	Weight Limit	Heel Height	For Ankle
1S03W-21R	21 cm	right	125 kg	10 mm	
1S03W-21L	21 cm	left	125 kg	10 mm	
1S03W-22R	22 cm	right	125 kg	10 mm	
1S03W-22L	22 cm	left	125 kg	10 mm	
1S03W-23R	23 cm	right	125 kg	10 mm	2S2-22-25
1S03W-23L	23 cm	left	125 kg	10 mm	
1S03W-24R	24 cm	right	125 kg	10 mm	
1S03W-24L	24 cm	left	125 kg	10 mm	
1S03W-25R	25 cm	right	125 kg	10 mm	
1S03W-25L	25 cm	left	125 kg	10 mm	
1S03W-26R	26 cm	right	125 kg	10 mm	
1S03W-26L	26 cm	left	125 kg	10 mm	
1S03W-27R	27 cm	right	125 kg	10 mm	
1S03W-27L	27 cm	left	125 kg	10 mm	
1S03W-28R	28 cm	right	125 kg	10 mm	2S2-26-30
1S03W-28L	28 cm	left	125 kg	10 mm	
1S03W-29R	29 cm	right	125 kg	10 mm	
1S03W-29L	29 cm	left	125 kg	10 mm	
1S03W-30R	30 cm	right	125 kg	10 mm	
1S03W-30L	30 cm	left	125 kg	10 mm	



1S23W Two Hole Single Axis Foot with Toe Split

Article No.	Size	Side	Weight Limit	Heel Height	For Ankle
1S23W-21R	21 cm	right	125 kg	10 mm	
1S23W-21L	21 cm	left	125 kg	10 mm	
1S23W-22R	22 cm	right	125 kg	10 mm	
1S23W-22L	22 cm	left	125 kg	10 mm	
1S23W-23R	23 cm	right	125 kg	10 mm	2S2-22-25
1S23W-23L	23 cm	left	125 kg	10 mm	
1S23W-24R	24 cm	right	125 kg	10 mm	
1S23W-24L	24 cm	left	125 kg	10 mm	
1S23W-25R	25 cm	right	125 kg	10 mm	
1S23W-25L	25 cm	left	125 kg	10 mm	
1S23W-26R	26 cm	right	125 kg	10 mm	
1S23W-26L	26 cm	left	125 kg	10 mm	
1S23W-27R	27 cm	right	125 kg	10 mm	2S2-26-30
1S23W-27L	27 cm	left	125 kg	10 mm	
1S23W-28R	28 cm	right	125 kg	10 mm	
1S23W-28L	28 cm	left	125 kg	10 mm	



2S2 Foot Adapter for Two Hole Single Axis Foot

Article No.	Adaptive Foot	Material	Product weight	Weight limit
2S2S-22-25	21-25cm	Stainless Steel	310 g	125 kg
2S2S-26-30	26-30cm	Stainless Steel	320 g	125 kg
2S2T-22-25	21-25cm	Titanium	180 g	125 kg
2S2T-26-30	26-30cm	Titanium	200 g	125 kg



2R22 Foot Connection Cap for Single-Axis-Footer Adapter

- Made of plastic with slot for easier insertion

Article No.	For Side	For Foot Size
2R22-22	Right/Left	22 cm
2R22-23	Right/Left	23 cm
2R22-24	Right/Left	24 cm
2R22-25	Right/Left	25 cm
2R22-26	Right/Left	26 cm
2R22-27	Right/Left	27 cm
2R22-28	Right/Left	28 cm



1N03W Low Profile Foot

- Designed for long stump and ankle disarticulation use.
- Ankle height can be customized to 35 mm.

Article No.	Size	Side	Weight	Heel	Ankle
			Limit	Height	Height
1N03W-21R	21 cm	right	125 kg	10 mm	40 mm
1N03W-21L	21 cm	left	125 kg	10 mm	40 mm
1N03W-22R	22 cm	right	125 kg	10 mm	40 mm
1N03W-22L	22 cm	left	125 kg	10 mm	40 mm
1N03W-23R	23 cm	right	125 kg	10 mm	45 mm
1N03W-23L	23 cm	left	125 kg	10 mm	45 mm
1N03W-24R	24 cm	right	125 kg	10 mm	45 mm
1N03W-24L	24 cm	left	125 kg	10 mm	45 mm
1N03W-25R	25 cm	right	125 kg	10 mm	45 mm
1N03W-25L	25 cm	left	125 kg	10 mm	45 mm
1N03W-26R	26 cm	right	125 kg	10 mm	45 mm
1N03W-26L	26 cm	left	125 kg	10 mm	45 mm
1N03W-27R	27 cm	right	125 kg	10 mm	45 mm
1N03W-27L	27 cm	left	125 kg	10 mm	45 mm
1N03W-28R	28 cm	right	125 kg	10 mm	45 mm
1N03W-28L	28 cm	left	125 kg	10 mm	45 mm
1N03W-29R	29 cm	right	125 kg	10 mm	45 mm
1N03W-29L	29 cm	left	125 kg	10 mm	45 mm



2N33 Foot Adapter for 1N03W Foot

Article No.	Connection	Material	Product	Weight
			Weight	Limit
2N33S	4-Arm Adapter	Stainless Steel	80g	125 kg



2N34 Foot Adapter for 1N03W Foot

Article No.	Connection	Material	Product	Weight
			Weight	Limit
2N34S	Round Plate	Stainless Steel	80g	125 kg

Modular Prosthetic Feet

Lower Limb for Children

Knee & Hip Joints

Modular Feet

Modular Components

Lock & Liner

Upper Prost.

Silicon Cosmetic Prost.

Accessories & Materials

Tools

Ortho. Components



1S04W One Hole Single Axis Foot

Article No.	Size	Side	Weight	Heel	For Ankle
			Limit	Height	
1S04W-21R	21 cm	right	125 kg	10 mm	2S1-22-25
1S04W-21L	21 cm	left	125 kg	10 mm	
1S04W-22R	22 cm	right	125 kg	10 mm	
1S04W-22L	22 cm	left	125 kg	10 mm	
1S04W-23R	23 cm	right	125 kg	10 mm	
1S04W-23L	23 cm	left	125 kg	10 mm	
1S04W-24R	24 cm	right	125 kg	10 mm	2S1-26-30
1S04W-24L	24 cm	left	125 kg	10 mm	
1S04W-25R	25 cm	right	125 kg	10 mm	
1S04W-25L	25 cm	left	125 kg	10 mm	
1S04W-26R	26 cm	right	125 kg	10 mm	
1S04W-26L	26 cm	left	125 kg	10 mm	
1S04W-27R	27 cm	right	125 kg	10 mm	2S1-26-30
1S04W-27L	27 cm	left	125 kg	10 mm	
1S04W-28R	28 cm	right	125 kg	10 mm	
1S04W-28L	28 cm	left	125 kg	10 mm	
1S04W-29R	29 cm	right	125 kg	10 mm	
1S04W-29L	29 cm	left	125 kg	10 mm	
1S04W-30R	30 cm	right	125 kg	10 mm	2S1-26-30
1S04W-30L	30 cm	left	125 kg	10 mm	



1S24W One Hole Single Axis Foot with Toe Split

Article No.	Size	Side	Weight	Heel	For Ankle
			Limit	Height	
1S24W-21R	21 cm	right	125 kg	10 mm	2S1-22-25
1S24W-21L	21 cm	left	125 kg	10 mm	
1S24W-22R	22 cm	right	125 kg	10 mm	
1S24W-22L	22 cm	left	125 kg	10 mm	
1S24W-23R	23 cm	right	125 kg	10 mm	
1S24W-23L	23 cm	left	125 kg	10 mm	
1S24W-24R	24 cm	right	125 kg	10 mm	2S1-26-30
1S24W-24L	24 cm	left	125 kg	10 mm	
1S24W-25R	25 cm	right	125 kg	10 mm	
1S24W-25L	25 cm	left	125 kg	10 mm	
1S24W-26R	26 cm	right	125 kg	10 mm	
1S24W-26L	26 cm	left	125 kg	10 mm	
1S24W-27R	27 cm	right	125 kg	10 mm	2S1-26-30
1S24W-27L	27 cm	left	125 kg	10 mm	
1S24W-28R	28 cm	right	125 kg	10 mm	
1S24W-28L	28 cm	left	125 kg	10 mm	

2S1 Foot Adapter

Article No.	For Foot	Material	Product Weight	Weight Limit
2S1S-22-25	21-25cm	Stainless Steel	310 g	125 kg
2S1S-26-30	26-30cm	Stainless Steel	320 g	125 kg
2S1T-22-25	21-25cm	Titanium	180 g	125 kg
2S1T-26-30	26-30cm	Titanium	200 g	125 kg



1FC1 Foot Shell with Cover

1FC2 Foot Shell without Cover

- Used for Freedom's foot module

<i>Article No.</i>	<i>Size</i>	<i>Side</i>	<i>Heel Height</i>	<i>With Cover</i>
1FC1-22R	22 cm	right	10 mm	Yes
1FC1-22L	22 cm	left	10 mm	Yes
1FC1-23R	23 cm	right	10 mm	Yes
1FC1-23L	23 cm	left	10 mm	Yes
1FC1-24R	24 cm	right	10 mm	Yes
1FC1-24L	24 cm	left	10 mm	Yes
1FC1-25R	25 cm	right	10 mm	Yes
1FC1-25L	25 cm	left	10 mm	Yes
1FC1-26R	26 cm	right	10 mm	Yes
1FC1-26L	26 cm	left	10 mm	Yes
1FC1-27R	27 cm	right	10 mm	Yes
1FC1-27L	27 cm	left	10 mm	Yes
1FC1-28R	28 cm	right	10 mm	Yes
1FC1-28L	28 cm	left	10 mm	Yes
1FC1-29R	29 cm	right	10 mm	Yes
1FC1-29L	29 cm	left	10 mm	Yes
1FC1-30R	30 cm	right	10 mm	Yes
1FC1-30L	30 cm	left	10 mm	Yes

<i>Article No.</i>	<i>Size</i>	<i>Side</i>	<i>Heel Height</i>	<i>With Cover</i>
1FC2-22R	22 cm	right	10 mm	No
1FC2-22L	22 cm	left	10 mm	No
1FC2-23R	23 cm	right	10 mm	No
1FC2-23L	23 cm	left	10 mm	No
1FC2-24R	24 cm	right	10 mm	No
1FC2-24L	24 cm	left	10 mm	No
1FC2-25R	25 cm	right	10 mm	No
1FC2-25L	25 cm	left	10 mm	No
1FC2-26R	26 cm	right	10 mm	No
1FC2-26L	26 cm	left	10 mm	No
1FC2-27R	27 cm	right	10 mm	No
1FC2-27L	27 cm	left	10 mm	No
1FC2-28R	28 cm	right	10 mm	No
1FC2-28L	28 cm	left	10 mm	No
1FC2-29R	29 cm	right	10 mm	No
1FC2-29L	29 cm	left	10 mm	No
1FC2-30R	30 cm	right	10 mm	No
1FC2-30L	30 cm	left	10 mm	No



1FC1



1FC2

Modular Prosthetic Feet

Lower Limb for Children

Knee & Hip Joints

Modular Feet

Modular Components

Lock & Liner

Upper Prost.

Silicon Cosmetic Prost.

Accessories & Materials

Tools

Ortho. Components



1FO1



1FO2

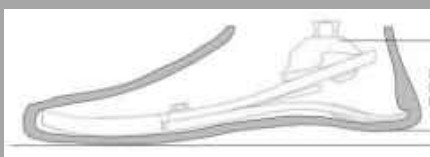

1FO1 Foot Shell with Cover

1FO2 Foot Shell without Cover

- Used for Ossur's foot module

Article No.	Cover	Step
1FO1	with cover	without step
1FO2	without cover	

Article No.	Size	Side	Heel Height	With Cover	With Step
1FO1-22R	22 cm	right	10 mm	Yes	No
1FO1-22L	22 cm	left	10 mm	Yes	No
1FO1-23R	23 cm	right	10 mm	Yes	No
1FO1-23L	23 cm	left	10 mm	Yes	No
1FO1-24R	24 cm	right	10 mm	Yes	No
1FO1-24L	24 cm	left	10 mm	Yes	No
1FO1-25R	25 cm	right	10 mm	Yes	No
1FO1-25L	25 cm	left	10 mm	Yes	No
1FO1-26R	26 cm	right	10 mm	Yes	No
1FO1-26L	26 cm	left	10 mm	Yes	No
1FO1-27R	27 cm	right	10 mm	Yes	No
1FO1-27L	27 cm	left	10 mm	Yes	No
1FO1-28R	28 cm	right	10 mm	Yes	No
1FO1-28L	28 cm	left	10 mm	Yes	No
1FO1-29R	29 cm	right	10 mm	Yes	No
1FO1-29L	29 cm	left	10 mm	Yes	No
1FO1-30R	30 cm	right	10 mm	Yes	No
1FO1-30L	30 cm	left	10 mm	Yes	No

Article No.	Size	Side	Heel Height	With Cover	With Step
1FO2-22R	22 cm	right	10 mm	No	No
1FO2-22L	22 cm	left	10 mm	No	No
1FO2-23R	23 cm	right	10 mm	No	No
1FO2-23L	23 cm	left	10 mm	No	No
1FO2-24R	24 cm	right	10 mm	No	No
1FO2-24L	24 cm	left	10 mm	No	No
1FO2-25R	25 cm	right	10 mm	No	No
1FO2-25L	25 cm	left	10 mm	No	No
1FO2-26R	26 cm	right	10 mm	No	No
1FO2-26L	26 cm	left	10 mm	No	No
1FO2-27R	27 cm	right	10 mm	No	No
1FO2-27L	27 cm	left	10 mm	No	No
1FO2-28R	28 cm	right	10 mm	No	No
1FO2-28L	28 cm	left	10 mm	No	No
1FO2-29R	29 cm	right	10 mm	No	No
1FO2-29L	29 cm	left	10 mm	No	No
1FO2-30R	30 cm	right	10 mm	No	No
1FO2-30L	30 cm	left	10 mm	No	No

1FO1-EVO Foot Shell with Cover

1FO2-EVO Foot Shell without Cover

- Used for Ossur's foot module

Article No.	Cover	Step
1FO1-EVO	with cover	with step
1FO2-EVO	without cover	

Article No.	Size	Side	Heel Height	With Cover	With Step
1FO1-EVO-22R	22 cm	right	10 mm	Yes	Yes
1FO1-EVO-22L	22 cm	left	10 mm	Yes	Yes
1FO1-EVO-23R	23 cm	right	10 mm	Yes	Yes
1FO1-EVO-23L	23 cm	left	10 mm	Yes	Yes
1FO1-EVO-24R	24 cm	right	10 mm	Yes	Yes
1FO1-EVO-24L	24 cm	left	10 mm	Yes	Yes
1FO1-EVO-25R	25 cm	right	10 mm	Yes	Yes
1FO1-EVO-25L	25 cm	left	10 mm	Yes	Yes
1FO1-EVO-26R	26 cm	right	10 mm	Yes	Yes
1FO1-EVO-26L	26 cm	left	10 mm	Yes	Yes
1FO1-EVO-27R	27 cm	right	10 mm	Yes	Yes
1FO1-EVO-27L	27 cm	left	10 mm	Yes	Yes
1FO1-EVO-28R	28 cm	right	10 mm	Yes	Yes
1FO1-EVO-28L	28 cm	left	10 mm	Yes	Yes
1FO1-EVO-29R	29 cm	right	10 mm	Yes	Yes
1FO1-EVO-29L	29 cm	left	10 mm	Yes	Yes
1FO1-EVO-30R	30 cm	right	10 mm	Yes	Yes
1FO1-EVO-30L	30 cm	left	10 mm	Yes	Yes

Article No.	Size	Side	Heel Height	With Cover	With Step
1FO2-EVO-22R	22 cm	right	10 mm	No	Yes
1FO2-EVO-22L	22 cm	left	10 mm	No	Yes
1FO2-EVO-23R	23 cm	right	10 mm	No	Yes
1FO2-EVO-23L	23 cm	left	10 mm	No	Yes
1FO2-EVO-24R	24 cm	right	10 mm	No	Yes
1FO2-EVO-24L	24 cm	left	10 mm	No	Yes
1FO2-EVO-25R	25 cm	right	10 mm	No	Yes
1FO2-EVO-25L	25 cm	left	10 mm	No	Yes
1FO2-EVO-26R	26 cm	right	10 mm	No	Yes
1FO2-EVO-26L	26 cm	left	10 mm	No	Yes
1FO2-EVO-27R	27 cm	right	10 mm	No	Yes
1FO2-EVO-27L	27 cm	left	10 mm	No	Yes
1FO2-EVO-28R	28 cm	right	10 mm	No	Yes
1FO2-EVO-28L	28 cm	left	10 mm	No	Yes
1FO2-EVO-29R	29 cm	right	10 mm	No	Yes
1FO2-EVO-29L	29 cm	left	10 mm	No	Yes
1FO2-EVO-30R	30 cm	right	10 mm	No	Yes
1FO2-EVO-30L	30 cm	left	10 mm	No	Yes



1FO1-EVO

1FO2-EVO

Modular Prosthetic Feet

Lower Limb for Children

Knee & Hip Joints

Modular Feet

Modular Components

Lock & Liner

Upper Prost.

Silicon Cosmetic Prost.

Accessories & Materials

Tools

Ortho. Components



99B10 Sock for Carbon foot

- Used to cover the composite foot module to protect the foot shell and eliminate noise between foot modules and foot shell.

Article No.	Sizes	Length	Width	Color
99B10-S	Small	30 cm	10 mm	White
99B10-L	Large	36-38 cm	10 mm	White
99B10B-S	Small	30 cm	10 mm	Black
99B10B-L	Large	36-38 cm	10 mm	Black

1NA8 Slip-resistant and Water-proof Foot

- Designed for seamless integration into daily life, this component is fully waterproof, allowing for confident use in both bath and shower environments.
- The specialized contour of the base provides superior anti-slip performance, ensuring stability and poise on wet surfaces.

Article No.	Size	Side	Weight Limit	Heel Height	With Cover Attachment
1NA8-22R	22 cm	right	125 kg	10 mm	No
1NA8-22L	22 cm	left	125 kg	10 mm	No
1NA8-23R	23 cm	right	125 kg	10 mm	No
1NA8-23L	23 cm	left	125 kg	10 mm	No
1NA8-24R	24 cm	right	125 kg	10 mm	No
1NA8-24L	24 cm	left	125 kg	10 mm	No
1NA8-25R	25 cm	right	125 kg	10 mm	No
1NA8-25L	25 cm	left	125 kg	10 mm	No
1NA8-26R	26 cm	right	125 kg	10 mm	No
1NA8-26L	26 cm	left	125 kg	10 mm	No
1NA8-27R	27 cm	right	125 kg	10 mm	No
1NA8-27L	27 cm	left	125 kg	10 mm	No
1NA8-28R	28 cm	right	125 kg	10 mm	No
1NA8-28L	28 cm	left	125 kg	10 mm	No

1P01 Pirogoff Foot

1P02 Pirogoff Foot w/ Reinforcing Cloth

- 1P01 without reinforcing cloth.
- 1P02 with reinforcing cloth.



1P01



1P02

Article No.		Size	Side	Weight	Heel
Without Reinforcing Cloth	With Reinforcing Cloth			Limit	Height
1P01-21R	1P02-21R	21 cm	right	125 kg	10 mm
1P01-21L	1P02-21L	21 cm	left	125 kg	10 mm
1P01-22R	1P02-22R	22 cm	right	125 kg	10 mm
1P01-22L	1P02-22L	22 cm	left	125 kg	10 mm
1P01-23R	1P02-23R	23 cm	right	125 kg	10 mm
1P01-23L	1P02-23L	23 cm	left	125 kg	10 mm
1P01-24R	1P02-24R	24 cm	right	125 kg	10 mm
1P01-24L	1P02-24L	24 cm	left	125 kg	10 mm
1P01-25R	1P02-25R	25 cm	right	125 kg	10 mm
1P01-25L	1P02-25L	25 cm	left	125 kg	10 mm
1P01-26R	1P02-26R	26 cm	right	125 kg	10 mm
1P01-26L	1P02-26L	26 cm	left	125 kg	10 mm
1P01-27R	1P02-27R	27 cm	right	125 kg	10 mm
1P01-27L	1P02-27L	27 cm	left	125 kg	10 mm
1P01-28R	1P02-28R	28 cm	right	125 kg	10 mm
1P01-28L	1P02-28L	28 cm	left	125 kg	10 mm
1P01-29R	1P02-29R	29 cm	right	125 kg	10 mm
1P01-29L	1P02-29L	29 cm	left	125 kg	10 mm
1P01-30R	1P02-30R	30 cm	right	125 kg	10 mm
1P01-30L	1P02-30L	30 cm	left	125 kg	10 mm

2WB5 Foot Attachment Block for Pirogoff Foot

- Used for Pirogoff foot.

Article No.	Sizes	Material	Foot Size
2WB5-S	Small	Wooden	21-25 cm
2WB5-L	Large	Wooden	26-30 cm



Modular Prosthetic Feet

Lower Limb for Children

Knee & Hip Joints

Modular Feet

Modular Components

Lock & Liner

Upper Prost.

Silicon Cosmetic Prost.

Accessories & Materials

Tools

Ortho. Components



1M10 Multi-flex Foot

- Max amputee weight 100kg
- Split toe for more appearance.
- Heel height adjustment based on ankle position on foot
- Size: 22-28 cm

Article No.		Size	Side	Heel	Toes
1M10	1M20			Height	
1M10-22R	1M20-22R	22 cm	right	Adjustable	Toe Split
1M10-22L	1M20-22L	22 cm	left	Adjustable	Toe Split
1M10-23R	1M20-23R	23 cm	right	Adjustable	Toe Split
1M10-23L	1M20-23L	23 cm	left	Adjustable	Toe Split
1M10-24R	1M20-24R	24 cm	right	Adjustable	Toe Split
1M10-24L	1M20-24L	24 cm	left	Adjustable	Toe Split
1M10-25R	1M20-25R	25 cm	right	Adjustable	Toe Split
1M10-25L	1M20-25L	25 cm	left	Adjustable	Toe Split
1M10-26R	1M20-26R	26 cm	right	Adjustable	Toe Split
1M10-26L	1M20-26L	26 cm	left	Adjustable	Toe Split
1M10-27R	1M20-27R	27 cm	right	Adjustable	Toe Split
1M10-27L	1M20-27L	27 cm	left	Adjustable	Toe Split
1M10-28R	1M20-28R	28 cm	right	Adjustable	Toe Split
1M10-28L	1M20-28L	28 cm	left	Adjustable	Toe Split

1MA Multi-flex Ankle

- Material: Aluminum alloy.
- Attention: please indicate ankle ball's hardness when ordering.
- There are hardness 60°/70°/80° available for ankle ball.

Article No.	Connection	Total Height	Product weight
1MA	Pyramid	90 mm	305 g
2MA	Pylon	135 mm	290 g
3MA	With Carbon tube	440 mm	285 g
4MA	Tube Clamp	100 mm	285 g



5MA Snubber Kit for Multi-flex Ankle

Article No.	Connection	Hardness
5MA01	Rubber	60°
5MA02	Rubber	70°
5MA03	Rubber	80°



Modular Components



4R63 4-Ear Socket Adapter

Article No.	Material	Product Weight	Weight Limit
4R63S	Stainless Steel	85 g	125 kg
4R63T	Titanium	49 g	125 kg



4R64 4-Ear Socket Adapter with Hole

Article No.	Material	Product Weight	Weight Limit
4R64S	Stainless Steel	82 g	125 kg
4R64T	Titanium	67 g	125 kg



4R111 4-Ear Rotatable Socket Adapter

Article No.	Material	Product Weight	Weight Limit
4R111S	Stainless Steel	130 g	125 kg
4R111T	Titanium	80 g	125 kg



4R133 4-Ear Rotatable Pyramid Adapter

Article No.	Material	Product Weight	Weight Limit
4R133S	Stainless Steel	156 g	125 kg
4R133T	Titanium	95 g	125 kg



4R112 4-Ear Female Socket Adapter

Article No.	Material	Product Weight	Weight Limit
4R112S	Stainless Steel	104 g	125 kg



4R122 4-Ear Lamination Anchor

Article No.	Material	Product Weight	Weight Limit
4R122S	Stainless Steel	78 g	125 kg
4R122T	Titanium	50 g	125 kg



4R136 Pyramid Insert

Article No.	Material	Product Weight	Weight Limit
4R136S	Stainless Steel	80 g	125 kg
4R136T	Titanium	50 g	125 kg



4R131 Female Insert

Article No.	Material	Product Weight	Weight Limit
4R131S	Stainless Steel	85 g	125 kg
4R131T	Titanium	50 g	125 kg

Modular Components

Lower Limb for Children



4R41 3-Arm Rotatable Female Adapter

Article No.	Material	Product Weight	Weight Limit
4R41S	Stainless Steel	155 g	125 kg
4R41T	SS. & Titanium	128 g	125 kg

* 4R41T: The Arm-L anchor part of the 4R41T is made of stainless steel.

Knee & Hip Joints



4R89 3-Arm Rotatable Pyramid Adapter

Article No.	Material	Product Weight	Weight Limit
4R89S	Stainless Steel	155 g	125 kg
4R89T	SS. & Titanium	128 g	125 kg

*4R89T: The Arm-L anchor part of the 4R89T is made of stainless steel.

Modular Feet



4R42 3-Arm Pyramid Adapter

Article No.	Material	Product Weight	Weight Limit
4R42S	Stainless Steel	120 g	125 kg

Modular Components



4R43 3-Arm Pyramid Adapter with Hole

Article No.	Material	Product Weight	Weight Limit
4R43S	Stainless Steel	118 g	125 kg

Lock & Liner



4R44 3-Arm Lamination Anchor

Article No.	Material	Product Weight	Weight Limit
4R44S	Stainless Steel	82 g	125 kg

Upper Prost.



4R123 4-Arm Lamination Anchor

Article No.	Material	Product Weight	Weight Limit
4R123S	Stainless Steel	55 g	125 kg

Silicon Cosmetic Prost.

Accessories & Materials



4R113S Lengthened Female Insert Stainless Steel

Article No.	Length	Material	Product Weight	Weight Limit
4R113S-40	40 mm	Stainless Steel	108 g	125 kg
4R113S-55	55 mm	Stainless Steel	124 g	125 kg
4R113S-70	70 mm	Stainless Steel	146 g	125 kg

4R113T Lengthened Female Insert Titanium

4R113T-40	40 mm	Titanium	68 g	125 kg
4R113T-55	55 mm	Titanium	78 g	125 kg
4R113T-70	70 mm	Titanium	92 g	125 kg

Tools

Ortho. Components



4R21 Tube Clamp Adapter

Article No.	Material	Product Weight	Weight Limit
4R21S	Stainless Steel	110 g	100 kg
4R21T	Titanium	73 g	100 kg



4R6 Tube Clamp Pyramid Adapter

Article No.	Material	Product Weight	Weight Limit
4R6S	Stainless Steel	110 g	125 kg
4R6T	Titanium	73 g	125 kg



4R20 Angled Tube Clamp Adapter

Article No.	Angle	Material	Product Weight	Weight Limit
4R20S	10°	Stainless Steel	110 g	125 kg
4R20T	10°	Titanium	88 g	125 kg



4R202 Angled Tube Clamp Adapter

Article No.	Angle	Material	Product Weight	Weight Limit
4R202S	20°	Stainless Steel	180 g	125 kg
4R202T	20°	Titanium	110 g	125 kg



4R28 Length Adjustment Adapter

Article No.	Length	Material	Product Weight	Weight Limit
4R28S	66-76 mm	Stainless Steel	238 g	125 kg
4R28T	66-76 mm	Titanium	150 g	125 kg



4R103 Slid Adapter

Article No.	Height	Material	Product Weight	Weight Limit
4R103S	65 mm	Stainless Steel	295 g	85 kg
4R103T	65 mm	Titanium	183 g	85 kg



4R30T Eccentric Tube Clamp Adapter

Article No.	Offset	Material	Product Weight	Weight Limit
4R30T	5 mm	Titanium	150 g	100 kg

Lower Limb for Children

Knee & Hip Joints

Modular Feet

Modular Components

Lock & Liner

Upper Prost.

Silicon Cosmetic Prost.

Accessories & Materials

Tools

Ortho. Components

Lower Limb for Children

Knee & Hip Joints

Modular Feet

Modular Components

Lock & Liner

Upper Prost.

Silicon Cosmetic Prost.

Accessories & Materials

Tools

Ortho. Components



2R2 Tube Assembly

2R3 Tube Assembly

Article No.	Length	Material	Product Weight	Weight Limit
2R2S	220 mm	SS/Aluminum	220 g	125 kg
2R3S	420 mm	SS/Aluminum	310 g	125 kg
2R2T	220 mm	TT/Aluminum	150 g	125 kg
2R3T	420 mm	TT/Aluminum	240 g	125 kg
2R2CS	220 mm	SS/Carbon Fiber	180 g	125 kg
2R3CS	420 mm	SS/Carbon Fiber	220 g	125 kg
2R2CT	220 mm	TT/Carbon Fiber	110 g	125 kg
2R3CT	420 mm	TT/Carbon Fiber	130 g	125 kg

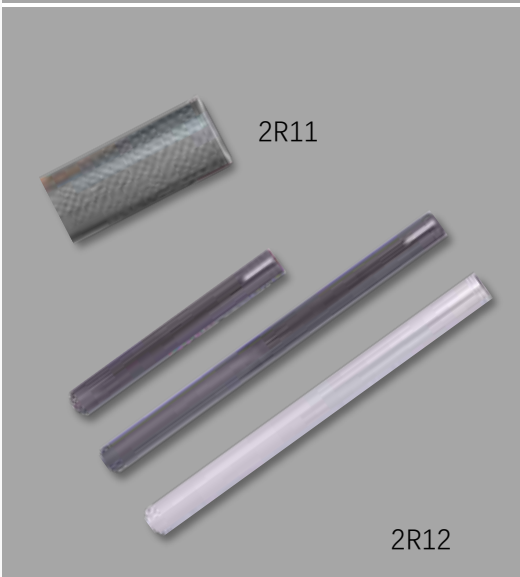

2R11 Connection Tube Carbon Fiber

2R12 Connection Tube Aluminum

Article No.	Length	Material	Product Weight	Weight Limit
2R11-400	400 mm	Carbon Fiber	160 g	125 kg
2R11-200	200 mm	Carbon Fiber	90 g	125 kg

Article No.	Length	Material	Product Weight	Weight Limit
2R12-400	400 mm	Aluminum	250 g	125 kg
2R12-200	200 mm	Aluminum	130 g	125 kg

2R50 Length Adjustable Tube Adapter

- For interim prothesis only.

Article No.	Length	Material	Product Weight	Weight Limit
2R50	270-420 mm	SS. & Alu.	340 g	85 kg



2R38 Angled Tube Assembly

Article No.	Angle	Material	Product Weight	Weight Limit
2R38S	10°	Stainless Steel	260 g	125 kg
2R38T	10°	Titanium	220 g	125 kg





4R22 4 Hole Female Adapter

Article No.	Material	Product Weight	Weight Limit
4R22S	Stainless Steel	90 g	125 kg
4R22T	Titanium	55 g	125 kg



4R23 4-Hole Pyramid Adapter

Article No.	Material	Product Weight	Weight Limit
4R23S	Stainless Steel	97 g	125 kg
4R23T	Titanium	56 g	125 kg



4R24 4-Hole Pyramid Adapter with Hole

Article No.	Material	Product Weight	Weight Limit
4R24S	Stainless Steel	87 g	125 kg
4R24T	Titanium	49 g	125 kg



4R77 4 Hole Rotatable Pyramid Adapter

Article No.	Material	Product Weight	Weight Limit
4R77S	Stainless Steel	160 g	125 kg
4R77T	Titanium	100 g	125 kg



4R96 4-Hole Rotatable Female Adapter

Article No.	Material	Product Weight	Weight Limit
4R96S	Stainless Steel	160 g	125 kg
4R96T	Titanium	100 g	125 kg



4R98 4-Hole Rotatable Base

Article No.	Material	Product Weight	Weight Limit
4R98S	Stainless Steel	110 g	125 kg
4R98T	Titanium	73 g	125 kg



4R47 4-Hole Rotatable Female Adapter

Article No.	Material	Product Weight	Weight Limit
4R47S	Stainless Steel	102 g	125 kg

Lower Limb for Children

Knee & Hip Joints

Modular Feet

Modular Components

Lock & Liner

Upper Prost.

Silicon Cosmetic Prost.

Accessories & Materials

Tools

Ortho. Components

Modular Components

Lower Limb for Children



Knee & Hip Joints



Modular Feet

Modular Components



Lock & Liner

Upper Prost.



Silicon Cosmetic Prost.

Accessories & Materials



Tools

Ortho. Components



4R73 Eccentric Adapter

Article No.	Axially Offset	Material	Product Weight	Weight Limit
4R73S	7 mm	Stainless Steel	105 g	125 kg
4R73T	7 mm	Titanium	67 g	125 kg

4R74 Eccentric Adapter

Article No.	Diagonally Offset	Material	Product Weight	Weight Limit
4R74S	5 mm	Stainless Steel	105 g	125 kg
4R74T	5 mm	Titanium	67 g	125 kg

5R1 Socket Attachment Block

Article No.	Material	Product Weight	Weight Limit
5R1	Wooden	290 g	100 kg

5R5 BK Thermoplastic Socket Adapter

Article No.	Material	Product Weight	Weight Limit
5R5S	Stainless Steel	196 g	125 kg
5R5T	Titanium	128 g	125 kg

4R19 BK Thermoplastic Socket Adapter

Article No.	Material	Product Weight	Weight Limit
4R19S	Stainless Steel	140 g	125 kg
4R19T	Titanium	90 g	125 kg

4R38 AK Thermoplastic Socket Adapter

Article No.	Material	Product Weight	Weight Limit
4R38S	Stainless Steel	130 g	125 kg



4R105 Slid Adapter

Article No.	Length	Material	Product	Weight
			Weight	Limit
4R105S-50	50 mm	Stainless Steel	250 g	85 kg
4R105S-50	50 mm	Stainless Steel	270 g	85 kg
4R105S-60	60 mm	Stainless Steel	295 g	85 kg
4R105S-75	75 mm	Stainless Steel	320 g	85 kg
4R105T-50	50 mm	Titanium	150 g	85 kg
4R105T-50	50 mm	Titanium	150 g	85 kg
4R105T-60	60 mm	Titanium	171 g	85 kg
4R105T-75	75 mm	Titanium	185 g	85 kg



4R72 Double Adapter

Article No.	Length	Material	Product	Weight
			Weight	Limit
4R72-32S	32 mm	Stainless Steel	137 g	125 kg
4R72-50S	50 mm	Stainless Steel	146 g	125 kg
4R72-60S	60 mm	Stainless Steel	165 g	125 kg
4R72-75S	75 mm	Stainless Steel	178 g	125 kg
4R72-32T	32 mm	Titanium	85 g	125 kg
4R72-50T	50 mm	Titanium	91 g	125 kg
4R72-60T	60 mm	Titanium	102 g	125 kg
4R72-75T	75 mm	Titanium	110 g	125 kg



4R70 Short Tube Adapter

Article No.	Length	Material	Product	Weight
			Weight	Limit
4R70-50S	50 mm	Stainless Steel	95 g	125 kg
4R70-60S	60 mm	Stainless Steel	108 g	125 kg
4R70-75S	75 mm	Stainless Steel	120 g	125 kg
4R70-50T	50 mm	Titanium	60 g	125 kg
4R70-60T	60 mm	Titanium	70 g	125 kg
4R70-75T	75 mm	Titanium	80 g	125 kg



4R84 Double Adapter with Pyramid

Article No.	Length	Material	Product	Weight
			Weight	Limit
4R84-32S	32 mm	Stainless Steel	137 g	125 kg
4R84-50S	50 mm	Stainless Steel	146 g	125 kg
4R84-60S	60 mm	Stainless Steel	165 g	125 kg
4R84-75S	75 mm	Stainless Steel	178 g	125 kg
4R84-32T	32 mm	Titanium	85 g	125 kg
4R84-50T	50 mm	Titanium	91 g	125 kg
4R84-60T	60 mm	Titanium	102 g	125 kg
4R84-75T	75 mm	Titanium	110 g	125 kg

Lower Limb for Children

Knee & Hip Joints

Modular Feet

Modular Components

Lock & Liner

Upper Prost.

Silicon Cosmetic Prost.

Accessories & Materials

Tools

Ortho. Components

Modular Components

Lower Limb for Children



4R64A 4-Ear Socket Adapter

Article No.	Material	Product Weight	Weight Limit
4R64A	Aluminum	75 g	75 kg

Knee & Hip Joints



4R21A Tube Clamp Adapter

Article No.	Length	Material	Product Weight	Weight Limit
4R21A	55 mm	Aluminum	90 g	75 kg

Modular Feet



2R2A AK Tube Assembly

2R3A BK Tube Assembly

Article No.	Length	Material	Product Weight	Weight Limit
2R2A	220mm	Alu. & Alu.	180 g	75 kg
2R3A	420mm	Alu. & Alu.	290 g	75 kg

Lock & Liner



2N1A Foot Adapter

Article No.	Material	Product Weight	Weight Limit
2N1A	Aluminum	105 g	75 kg

Upper Prost.



4R22A 4-Hole Female Adapter

Article No.	Material	Product Weight	Weight Limit
4R22A	Aluminum	62 g	75 kg

Silicon Cosmetic Prost.



4R24A 4-Hole Pyramid Adapter

Article No.	Material	Product Weight	Weight Limit
4R24A	Aluminum	67 g	75 kg

Accessories & Materials



4R30A Eccentric Tube Clamp Adapter

Article No.	Offset	Material	Product Weight	Weight Limit
4R30A	4.5mm	Aluminum	84 g	75 kg

Tools

Ortho. Components



4R32A Eccentric Tube Adapter

Article No.	Offset	Length	Product Weight	Weight Limit
4R32A-75	4.5mm	75 mm	100 g	75 kg
4R32A-200	4.5mm	200 mm	185 g	75 kg



4R20A Angled Tube Adapter

Article No.	Angle	Material	Product Weight	Weight Limit
4R20A	10°	Aluminum	72 g	75 kg



4R25A BK Thermoplastic Socket Adapter with Tube

Article No.	Length	Material	Product Weight	Weight Limit
4R25A	81 mm	Aluminum	160 g	75 kg



4R26A BK Thermoplastic Socket Adapter

Article No.	Length	Material	Product Weight	Weight Limit
4R26A	54 mm	Aluminum	170 g	75 kg



4R29A AK Thermoplastic Socket Adapter

Article No.	Length	Material	Product Weight	Weight Limit
4R29A	46 mm	Aluminum	250 g	75 kg



4R37A AK Rotatable Socket Adapter

Article No.	Material	Product Weight	Weight Limit
4R37A	Aluminum	118 g	75 kg



4R96A 4-Hole Rotatable Female Adapter

Article No.	Offset	Material	Product Weight	Weight Limit
4R96A	Aluminum	Aluminum	84 g	75 kg

Lower Limb for Children

Knee & Hip Joints

Modular Feet

Modular Components

Look & Liner

Upper Prost.

Silicon Cosmetic Prost.

Accessories & Materials

Tools

Ortho. Components

Modular Components

Lower Limb for Children



Knee & Hip Joints



Modular Feet

Modular Components



Lock & Liner

Upper Prost.

Silicon Cosmetic Prost.

Accessories & Materials

Tools

Ortho. Components



4R72A Double Adapter

<i>Article No.</i>	<i>Length</i>	<i>Material</i>	<i>Product Weight</i>	<i>Weight Limit</i>
4R72A-32	32 mm	Aluminum	98 g	75 kg
4R72A-50	50 mm	Aluminum	120 g	75 kg
4R72A-60	60 mm	Aluminum	141 g	75 kg
4R72A-75	75 mm	Aluminum	163 g	75 kg

4R84A Double Adapter with Pyramid

<i>Article No.</i>	<i>Length</i>	<i>Material</i>	<i>Product Weight</i>	<i>Weight Limit</i>
4R84A-50	50 mm	Aluminum	109 g	75 kg
4R84A-60	60mm	Aluminum	130 g	75 kg
4R84A-75	75 mm	Aluminum	151 g	75 kg

4R70A Short Tube Adapter

<i>Article No.</i>	<i>Length</i>	<i>Material</i>	<i>Product Weight</i>	<i>Weight Limit</i>
4R70A-32	32 mm	Aluminum	67 g	75 kg
4R70A-50	50 mm	Aluminum	72 g	75 kg
4R70A-60	60 mm	Aluminum	76 g	75 kg
4R70A-75	75 mm	Aluminum	80 g	75 kg

Lock & Liner Systems

Lower Limb for Children

Knee & Hip Joints

Modular Feet

Modular Components

Lock & Liner

Upper Prost.

Silicon Cosmetic Prost.

Accessories & Materials

Tools

Ortho. Components



6BS20-1 Pyramid Shuttle Lock

- Installation height approx:33 mm
- Max. weight: 125 kg

Article No.	Specifications	Material	Weight
6BS20-10	with 4-Ear lamination anchor	Aluminum housing	250g
6BS20-11	with 4-Arm lamination anchor	Aluminum housing	280g



6BS20-2 Female Shuttle Lock

- Installation height approx:33 mm
- Max. weight: 125 kg

Article No.	Specifications	Material	Weight
6BS20-20	with 4-Ear lamination anchor	Aluminum housing	280g
6BS20-21	with 4-Arm lamination anchor	Aluminum housing	300g



6BS30 Build-in Shuttle Lock

- Installation height approx:23 mm
- Suitable for thermoplastic and lamination sockets

Article No.	Specifications	Material
6BS30	Built in socket	Aluminum housing



6BS40 Shuttle Lock

- Installation height approx:30 mm
- Max. weight: 125 kg
- Suitable for thermoplastic and lamination sockets

Article No.	Specifications	Material
6BS40	with lamination disc, flat construction	Aluminum housing

Lower Limb for Children

Knee & Hip Joints

Modular Feet

Modular Components

Lock & Liner

Upper Prost.

Silicon Cosmetic Prost.

Accessories & Materials

Tools

Ortho. Components



6BS50 Shuttle Lock with Pyramid

- Installation height approx:35 mm
- Max. weight: 125 kg
- Suitable for thermoplastic and lamination sockets

Article No.	Specifications	Material
6BS50	with lamination disc, distal Pyramid construction	Aluminum housing

6BT50 Shuttle Lock

- Installation height approx:35 mm
- Max. weight: 125 kg

Article No.	Specifications	Material
6BT50T-10	Pyramid, 4-Ear anchor	Titanium housing
6BT50T-11	Pyramid, 4-Arm anchor	Titanium housing
6BT50S-10	Pyramid, 4-Ear anchor	SS housing
6BT50S-11	Pyramid, 4-Arm anchor	SS housing



6BT51 Shuttle Lock

- Installation height approx:35 mm
- Max. weight: 125 kg

Article No.	Specifications	Material
6BT51S-20	Female, 4-Ear anchor	SS housing
6BT51S-21	Female, 4-Arm anchor	SS housing





6BS3140 Base Shuttle Lock

- Installation height approx: 17 mm
- Suitable for thermoplastic and lamination sockets

Article No.	Specifications	Material
6BS3140	Build-in socket	Plastic housing



6AC3140 lamination Dummy

- Accessory, for 6BS3140 lock use.
- Reusable.

Article No.	Specifications	Material
6AC3140	Outer diameter-65 mm.	Aluminum



6CBS50 Child Shuttle Lock

- Installation Height approx.: 28mm
- Max weight: 65kg
- Suitable for thermoplastic and lamination sockets

Article No.	Specifications	Material
6CBS50	with lamination disc, distal Pyramid construction	Aluminum housing



6BL13250 Shuttle Lock for Upper Limb

- Article No.: 6BL13250
- Material: Aluminum

Lower Limb for Children

Knee & Hip Joints

Modular Feet

Modular Components

Lock & Liner

Upper Prost.

Silicon Cosmetic Prost.

Accessories & Materials

Tools

Ortho. Components

Lower Limb for Children

Knee & Hip Joints

Modular Feet

Modular Components

Lock & Liner

Upper Prost.

Silicon Cosmetic Prost.

Accessories & Materials

Tools

Ortho. Components



3010L

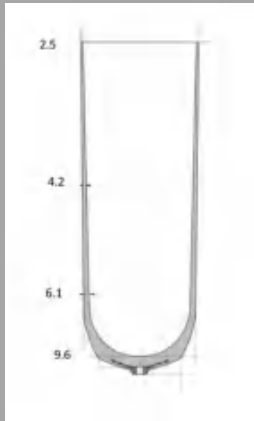

3010L Transtibial silicone liner

- The Forte liner is a silicone gel liner with mineral oil embedded. The soft gel with flexible fabric allows snug fit of various contours without restriction.
- It is suitable for moderate to high activity patients. The matrix which built to the liner prevents distal elongation of the liner for locking application.

Article No.	Stump Cir.
Locking type 	At 6cm above the distal of stump
3010L-18	16-19cm
3010L-20	19-21cm
3010L-22	21-23cm
3010L-23.5	23-24cm
3010L-25	24-26cm
3010L-26.5	26-27cm
3010L-28	27-29cm
3010L-30	29-31cm
3010L-32	31-33cm
3010L-34	33-35cm
3010L-36	35-38cm

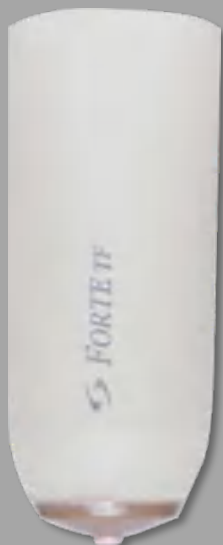

3090L

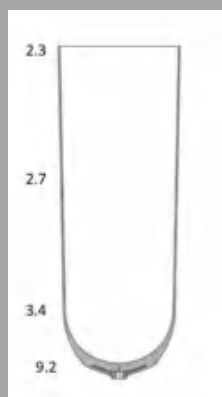

3090L Transfemoral silicone liner

- The Forte liner is a silicone gel liner with mineral oil embedded. The soft gel with flexible fabric allows snug fit of various contours without restriction.
- It is suitable for moderate to high activity patients. The matrix which built to the liner prevents distal elongation of the liner for locking application.

Article No.	Stump Cir.
Locking type 	At 6cm above the distal of stump
3090L-30	28-31cm
3090L-32	31-33cm
3090L-34	33-35cm
3090L-36	35-37cm
3080L-38	37-39cm
3090L-40	39-42cm
3090L-50	42-46cm



AKDT/AKFR Extreme™ Liner

AKDTHD/AKFRHD Extreme™ HD Liner

- Material: Grip Gel
- Fabric: Brown Fabric
- Activity Level: 1,2,3
- Thickness: 3mm, 6mm

Sizing Chart

Measure the circumference of the residual limb at 6 cm above the distal end.

Measured size (cm)	Locking 3mm or 6mm uniform U	Cushion 3mm or 6mm uniform U
16-19 cm	AKDT16-(3 or 6)	AKFR16-(3 or 6)
20-23 cm	AKDT20-(3 or 6)	AKFR20-(3 or 6)
24-25 cm	AKDT24-(3 or 6)	AKFR24-(3 or 6)
26-27 cm	AKDT26-(3 or 6)	AKFR26-(3 or 6)
28-31 cm	AKDT28-(3 or 6)	AKFR28-(3 or 6)
32-34 cm	AKDT32-(3 or 6)	AKFR32-(3 or 6)
35-37 cm	AKDT35-(3 or 6)	AKFR35-(3 or 6)
38-43 cm	AKDT38-(3 or 6)	AKFR38-(3 or 6)
44-53 cm	AKDT44-(3 or 6)	AKFR44-(3 or 6)

Measured size (cm)	Locking 3mm or 6mm uniform U	Cushion 3mm or 6mm uniform U
16-19 cm	AKDTHD16-(3 or 6)	AKFRHD16-(3 or 6)
20-23 cm	AKDTHD20-(3 or 6)	AKFRHD20-(3 or 6)
24-25 cm	AKDTHD24-(3 or 6)	AKFRHD24-(3 or 6)
26-27 cm	AKDTHD26-(3 or 6)	AKFRHD26-(3 or 6)
28-31 cm	AKDTHD28-(3 or 6)	AKFRHD28-(3 or 6)
32-34 cm	AKDTHD32-(3 or 6)	AKFRHD32-(3 or 6)
35-37 cm	AKDTHD35-(3 or 6)	AKFRHD35-(3 or 6)
38-43 cm	AKDTHD38-(3 or 6)	AKFRHD38-(3 or 6)
44-53 cm	AKDTHD44-(3 or 6)	AKFRHD44-(3 or 6)

SFX Flex Sleeve

- Material: High Density Gel
- Fabric: Seamless Knitted Fabric
- Activity Level: 1,2,3,4
- Thickness: 3mm

Sizing Chart

- Measure the circumference of the residual limb at 6 cm above the distal end.

Measured size (cm)	3mm Beige	6mm Gray
34-37 cm	SFX20-3B	SFX20-3G
36-39 cm	SFX23-3B	SFX23-3G
38-42 cm	SFX26-3B	SFX26-3G
41-46 cm	SFX29-3B	SFX29-3G
50-50 cm	SFX32-3B	SFX32-3G



- Lower Limb for Children
- Knee & Hip Joints
- Modular Feet
- Modular Components
- Lock & Liner
- Upper Prost.
- Silicon Cosmetic Prost.
- Accessories & Materials
- Tools
- Ortho. Components



ECDTHD/ECFRHD Eco™ Liner

- Material: High Density Gel
- Fabric: Seamless Knitted Fabric
- Activity Level: 1,2,3,4
- Thickness: 3mm, 6mm

Sizing Chart

Measure the circumference of the residual limb at 6 cm above the distal end.

Measured size (cm)	Locking 3mm or 6mm uniform U	Cushion 3mm or 6mm uniform U
20-23 cm	ECDTHD20-(3 or 6)	ECFRHD20-(3 or 6)
24-25 cm	ECDTHD24-(3 or 6)	ECFRHD24-(3 or 6)
26-27 cm	ECDTHD26-(3 or 6)	ECFRHD26-(3 or 6)
28-31 cm	ECDTHD28-(3 or 6)	ECFRHD28-(3 or 6)
32-34 cm	ECDTHD32-(3 or 6)	ECFRHD32-(3 or 6)
35-37 cm	ECDTHD35-(3 or 6)	ECFRHD35-(3 or 6)
38-43 cm	ECDTHD38-(3 or 6)	ECFRHD38-(3 or 6)
44-53 cm	ECDTHD44-(3 or 6)	ECFRHD44-(3 or 6)



ELDT/ELFR Easy Gel Liner®

- Material: Easy Gel
- Fabric: Beige Fabric
- Activity Level: 1,2,3,4
- Thickness: 3mm, 6mm

Sizing Chart

Measure the circumference of the residual limb at 6 cm above the distal end.

Measured size (cm)	Locking 3mm or 6mm uniform U	Cushion 3mm or 6mm uniform U
10-15cm	ELDT10-(3 or 6)	ELFR10-(3 or 6)
16-20 cm	ELDT16-(3 or 6)	ELFR16-(3 or 6)
21-24 cm	ELDT20-(3 or 6)	ELFR20-(3 or 6)
25-28 cm	ELDT24-(3 or 6)	ELFR24-(3 or 6)
29-30 cm	ELDT26-(3 or 6)	ELRF26-(3 or 6)
31-34 cm	ELDT28-(3 or 6)	ELRF28-(3 or 6)
35-41 cm	ELDT32-(3 or 6)	ELFR32-(3 or 6)
42-48 cm	ELDT38-(3 or 6)	ELFR38-(3 or 6)
49-60 cm	ELDT44-(3 or 6)	ELFR44-(3 or 6)



SPDT/SPFR Superior Performance Liner

- Material: Grip Gel
- Fabric: Black Fabric
- Activity Level: 1,2,3
- Thickness: 3mm, 6mm

Sizing Chart

Measure the circumference of the residual limb at 6 cm above the distal end.

Measured size (cm)	Locking 3mm or 6mm uniform U	Cushion 3mm or 6mm uniform U
16-19cm	SPDT16-(3 or 6)	SPFR16-(3 or 6)
20-23cm	SPDT20-(3 or 6)	SPFR20-(3 or 6)
24-25cm	SPDT24-(3 or 6)	SPFR24-(3 or 6)
26-27cm	SPDT26-(3 or 6)	SPFR26-(3 or 6)
28-31cm	SPDT28-(3 or 6)	SPFR28-(3 or 6)
32-34cm	SPDT32-(3 or 6)	SPFR32-(3 or 6)
35-37cm	SPDT35-(3 or 6)	SPFR35-(3 or 6)
38-43 cm	SPDT38-(3 or 6)	SPFR38-(3 or 6)
44-53cm	SPDT44-(3 or 6)	SPFR44-(3 or 6)

SPDTHD/SPFRHD Superior Performance HD Liner

- Material: High Density Gel
- Fabric: Black Fabric
- Activity Level: 2,3,4
- Thickness: 3mm, 6mm

Sizing Chart

Measure the circumference of the residual limb at 6 cm above the distal end.

Measured size (cm)	Locking 3mm or 6mm uniform U	Cushion 3mm or 6mm uniform U
16-19cm	SPDTHD16-(3 or 6)	SPFRHD16-(3 or 6)
20-23cm	SPDTHD20-(3 or 6)	SPFRHD20-(3 or 6)
24-25cm	SPDTHD24-(3 or 6)	SPFRHD24-(3 or 6)
26-27cm	SPDTHD26-(3 or 6)	SPFRHD26-(3 or 6)
28-31cm	SPDTHD28-(3 or 6)	SPFRHD28-(3 or 6)
32-34cm	SPDTHD32-(3 or 6)	SPFRHD32-(3 or 6)
35-37cm	SPDTHD35-(3 or 6)	SPFRHD35-(3 or 6)
38-43 cm	SPDTHD38-(3 or 6)	SPFRHD38-(3 or 6)
44-53cm	SPDTHD44-(3 or 6)	SPFRHD44-(3 or 6)

Lower Limb for Children

Knee & Hip Joints

Modular Feet

Modular Components

Lock & Liner

Upper Prost.

Silicon Cosmetic Prost.

Accessories & Materials

Tools

Ortho. Components

- Lower Limb for Children
- Knee & Hip Joints
- Modular Feet
- Modular Components
- Lock & Liner
- Upper Prost.
- Silicon Cosmetic Prost.
- Accessories & Materials
- Tools
- Ortho. Components



CLBNDT/CLBNFR Economical Liner

- Material: Gel
- Activity Level: 1,2,3, 4
- Thickness: 3mm
- **Logo Customizable**

Sizing Chart

Measure the circumference of the residual limb at 6 cm above the distal end.

Measured size (cm)	Locking 3mm uniform U	Cushion 3mm uniform U
20-23cm	CLBNDT20-3	CLBNFR20-3
24-25cm	CLBNDT24-3	CLBNFR24-3
26-27cm	CLBNDT26-3	CLBNFR26-3
28-31cm	CLBNDT28-3	CLBNFR28-3
32-34cm	CLBNDT32-3	CLBNFR32-3
35-37cm	CLBNDT35-3	CLBNFR35-3
38-43 cm	CLBNDT38-3	CLBNFR38-3



PLDTHD/PLFRHD HD Economical Liner

- Material: High Density Gel
- Thickness: 3/6mm
- **Logo Customizable**

Sizing Chart

Measure the circumference of the residual limb at 6 cm above the distal end.

Measured size (cm)	Locking 3/6mm uniform U	Cushion 3/6mm uniform U
20-23cm	PLDTHD20-3/6	PLFRHD20-3/6
24-25cm	PLDTHD24-3/6	PLFRHD24-3/6
26-27cm	PLDTHD26-3/6	PLFRHD26-3/6
28-31cm	PLDTHD28-3/6	PLFRHD28-3/6
32-34cm	PLDTHD32-3/6	PLFRHD32-3/6
38-43 cm	PLDTHD38-3/6	PLFRHD38-3/6



USHSL/USHSC UltraSeal Silicone Liner
USLSL/USLSC UltraSeal Silicone Liner
USUSL/ USUSC UltraSeal Silicone Liner

- Material: High Density Gel
- Thickness: 2mm

Sizing Chart

Measure the circumference of the residual limb at 6 cm above the distal end.



<i>Measured size (cm)</i>	<i>High Ring Locking 2mm uniform</i> U	<i>High Ring Cushion 2mm uniform</i> U
20-21 cm	USHSL20	USHSC20
22-23cm	USHSL22	USHSC22
24-25cm	USHSL24	USHSC24
26-27cm	USHSL26	USHSC26
28-31cm	USHSL28	USHSC28
32-34cm	USHSL32	USHSC32
35-37cm	USHSL35	USHSC35
38-40 cm	USHSL38	USHSC38
41-43cm	USHSL41	USHSC41
44-47cm	USHSL44	USHSC44

<i>Measured size (cm)</i>	<i>Low Ring Locking 2mm uniform</i> U	<i>Low Ring Cushion 2mm uniform</i> U
20-21 cm	USLSL20	USHSL20
22-23cm	USLSL22	USHSL22
24-25cm	USLSL24	USHSL24
26-27cm	USLSL26	USHSL26
28-31cm	USLSL28	USHSL28
32-34cm	USLSL32	USHSL32
35-37cm	USLSL35	USHSL35
38-40 cm	USLSL38	USHSL38
41-43cm	USLSL41	USHSL41
44-47cm	USLSL44	USHSL44

<i>Measured size (cm)</i>	<i>Ultra Low Ring Locking 2mm uniform</i> U	<i>Ultra Low Ring Cushion 2mm uniform</i> U
20-21 cm	USUSL20	USUSC20
22-23cm	USUSL22	USUSC22
24-25cm	USUSL24	USUSC24
26-27cm	USUSL26	USUSC26
28-31cm	USUSL28	USUSC28
32-34cm	USUSL32	USUSC32
35-37cm	USUSL35	USUSC35
38-40 cm	USUSL38	USUSC38
41-43cm	USUSL41	USUSC41
44-47cm	USUSL44	USUSC44

Lower Limb for Children

Knee & Hip Joints

Modular Feet

Modular Components

Lock & Liner

Upper Prost.

Silicon Cosmetic Prost.

Accessories & Materials

Tools

Ortho. Components

Lower Limb for Children

Knee & Hip Joints

Modular Feet

Modular Components

Lock & Liner

Upper Prost.

Silicon Cosmetic Prost.

Accessories & Materials

Tools

Ortho. Components





GPDT/GPFR General Purpose Liner

- Material: Grip Gel
- Fabric: Beige Fabric
- Activity Level: 1,2,3,4
- Thickness: 3mm, 6mm

Sizing Chart

Measure the circumference of the residual limb at 6 cm above the distal end.

Measured size (cm)	Locking 3mm or 6mm uniform 	Cushion 3mm or 6mm uniform 
10-15cm	GPDT10-(3 or 6)	GPFR10-(3 or 6)
16-20 cm	GPDT16-(3 or 6)	GPFR16-(3 or 6)
21-24 cm	GPDT20-(3 or 6)	GPFR20-(3 or 6)
25-28 cm	GPDT24-(3 or 6)	GPRF24-(3 or 6)
29-30 cm	GPDT26-(3 or 6)	GPRF26-(3 or 6)
31-34 cm	GPDT28-(3 or 6)	GPFR28-(3 or 6)
35-41 cm	GPDT32-(3 or 6)	GPFR32-(3 or 6)
42-48 cm	GPDT38-(3 or 6)	GPFR38-(3 or 6)
49-60 cm	GPDT44-(3 or 6)	GPFR44-(3 or 6)



503D6 Gel. Sock

- High elastic reinforcement sock with inner gel coating. For transtibial amputees.

Article No.	Length	Distal Cir. (3cm)	Proximal Cir.
503D6-S	27 cm	20 cm	22 cm
503D6-L	36 cm	22 cm	24 cm



616S-T Silicone Comfort Pad

- It is a distal pad, which can be used to provide additional cushion in sensitive areas and also used to manage volume fluctuations of the limb and socket interface.

Article No.	Size	Cir.	Weight
616S-T-S	Small	14-19 cm	32 g
616S-T-M	Medium	19-23 cm	42 g
616S-T-L	Large	23-27 cm	70 g
616S-T-XL	X-Large	27-31 cm	108 g
616S-T-XXL	XX-Large	31-35 cm	125 g
616S-T-XXXL	XXX-Large	35-38 cm	148 g

Upper Prostheses

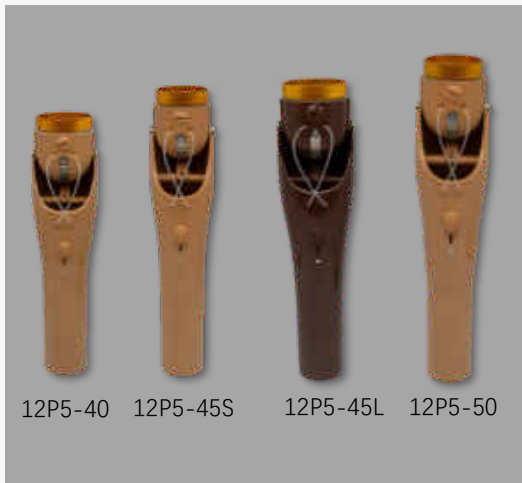

12P5 Elbow Set-up

- Passive Elbow locking, with 13 locking positions in 8° increments.
- Rotatable Elbow joint. Plastic forearm shell.
- Caucasian and brown colors available.

Article No.	Lamination ring Φ	Wrist inner Φ
12P5-50	Φ 64 mm	Φ 50 mm
12P5-50/L	Φ 64 mm	Φ 50 mm
12P5-50/S	Φ 54.5 mm	Φ 50 mm
12P5-40	Φ 54.5 mm	Φ 40 mm



12P1 Elbow Hinge

- Extension or flexion when pressing button.
- To lock the hinge when loosening the button.

Article No.	For Arm side	Product weight
12P1-L	Left	172 g
12P1-R	Right	172 g



12P4 Elbow Hinge

- Flexion is controlled by cable.
- When free, the forearm automatically bends upward.
- When locking, there are five locking positions.

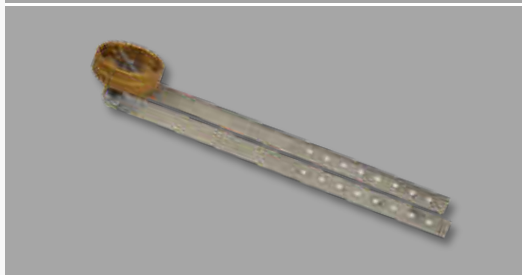

12HZ4 Shoulder Joint

- For Shoulder disarticulation use.
- The joint has two movable axes, which can swing in medial/lateral directions, and in ventral/dorsal directions.

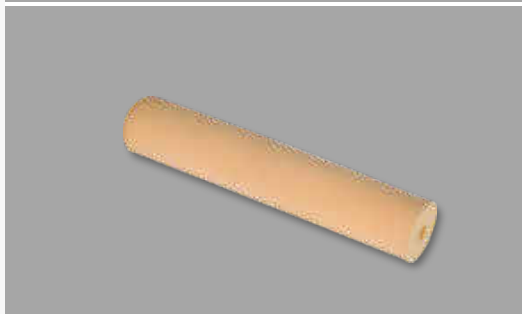

13R11 Cosmetic Foam

- For upper prosthetics use.

Article No.	Specifications	Length
13R11	Φ 120mm/ Φ 22 mm	650 mm

Lower Limb for Children

Knee & Hip Joints

Modular Feet

Modular Components

Lock & Liner

Upper Prost.

Silicon Cosmetic Prost.

Accessories & Materials

Tools

Ortho. Components



12HZ50 Elbow-Arm Component

- For above-elbow short-length residual limb use.

Article No.	For Arm side
12HZ50-L	Left
12HZ50-R	Right



12HZ51 Elbow-Arm Component

- For above-elbow medium-length residual limb use

Article No.	For Arm side
12HZ51-L	Left
12HZ51-R	Right



12HZ56 Elbow-Arm Component

- For above-elbow long-length residual limb use.

Article No.	For Arm side
12HZ56-L	Left
12HZ56-R	Right



12HZ60 Shoulder Disarticulation Component

- For shoulder disarticulation use.

Article No.	For Arm side
12HZ60-L	Left
12HZ60-R	Right

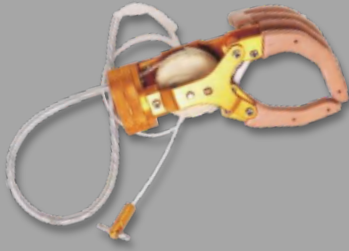

HS30 Hand Cable Controlled

- Voluntary closing

Article No.	Size	Lamination Ring Φ	For side
HS30-R8	Large	50 mm	Right
HS30-L8	Large	50 mm	Left
HS30-R7	Small	50 mm	Right
HS30-L7	Small	50 mm	Left



HS32 Hand Cable Controlled

- Voluntary closing

Article No.	Size	Lamination Ring Φ	For side
HS32-R8	Large	50 mm	Right
HS32-L8	Large	50 mm	Left
HS32-R7.5	Medium	50/50mm	Right
HS32-L7.5	Medium	50/50mm	Left
HS32-R7	Small	50 mm	Right
HS32-L7	Small	50 mm	Left



HW30 Multi-wrist Unit

- Connect to HS35 hand or connect to HS70-BF cosmetic glove with filler & bolt

Article No.	Size	Lamination Ring Φ	Internal Thread
HW30L	Large	50 mm	M12x1.5mm
HW30M	Medium	50 mm	M12x1.5mm
HW30S	Small	40 mm	M12x1.5mm



HZ30 Passive Hand

- Normally closing

Article No.	Size	Lamination Ring Φ	For side
HZ30-R8	Large	50 mm	Right
HZ30-L8	Large	50 mm	Left
HZ30-R7	Small	50 mm	Right
HZ30-L7	Small	50 mm	Left

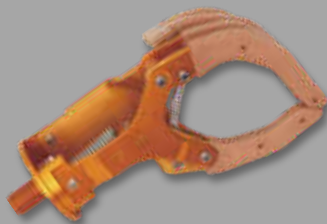

HZ35 Passive Hand

- Normally closing

Article No.	Size	Thread	For side
HZ35-R8	Large	M12x1.5mm	Right
HZ35-L8	Large	M12x1.5mm	Left
HZ35-R7	Small	M12x1.5mm	Right
HZ35-L7	Small	M12x1.5mm	Left



HZ32 Passive Hand

- Normally closing

Article No.	Size	Lamination Ring Φ	For side
HZ32-R8	Large	50 mm	Right
HZ32-L8	Large	50 mm	Left
HZ32-R7	Small	50 mm	Right
HZ32-L7	Small	50 mm	Left

Lower Limb for Children

Knee & Hip Joints

Modular Feet

Modular Components

Lock & Liner

Upper Prost.

Silicon Cosmetic Prost.

Accessories & Materials

Tools

Ortho. Components

Silicon Cosmetic Products

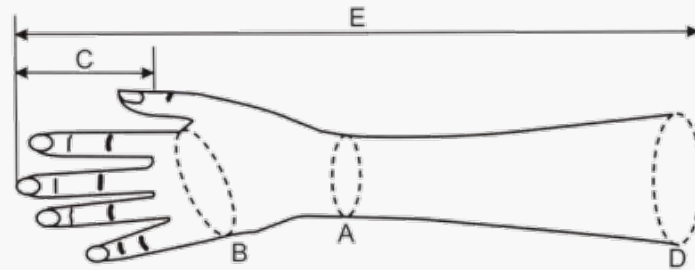

- Lower Limb for Children
- Knee & Hip Joints
- Modular Feet
- Modular Components
- Lock & Liner
- Upper Prost.
- Silicon Cosmetic Prost.
- Accessories & Materials
- Tools
- Ortho. Components



CHS70 Child Cosmetic Silicone Glove

Article No.	Size	A	B	C
		Wrist Cir.	Palm Cir.	Middel Finger Length
CHS70-L	Large	130 mm	150 mm	55 mm
CHS70-M	Medium	115 mm	140 mm	50 mm
CHS70-S	Small	115 mm	115 mm	50 mm

* List above are stand sizes.

* Please specify when ordering glove with inner filler.



CHS80 Child Mechanical Glove

Article No.	Descriptions	A	B	C
		Wrist Cir.	Palm Cir.	Middel Finger Length
CHS80	One size, Left/ Right	135 mm	165 mm	60 mm



CHZ30 Child Passive Hand

Article No.	Descriptions	Lamination Ring Diameter
CHZ30-R6	Right	Φ40 mm
CHZ30-L6	Left	Φ40 mm



HS70F Female Cosmetic Silicone Glove

Article No.	Sizes	A	B	C	E
		Wrist Circ.	Palm Circ.	Middel Finger Length	Length
HS70F-XL	Extra Large	180mm	210mm	80mm	330 mm
HS70F-L	Large	160 mm	195 mm	80 mm	330 mm
HS70F-M	Medium	155 mm	180 mm	70 mm	320 mm
HS70F-S	Small	140 mm	165 mm	68-70 mm	310 mm



HS70F-Z Female Cosmetic Glove with Zip & Filler

Article No.	Sizes	A	B	C	E
		Wrist Circ.	Palm Circ.	Middel Finger Length	Length
HS70F-Z-XL	Extra Large	180mm	210mm	80mm	330 mm
HS70F-Z-L	Large	160 mm	195 mm	80 mm	215 mm
HS70F-Z-M	Medium	155 mm	180 mm	70 mm	205 mm
HS70F-Z-S	Small	140 mm	165 mm	68-70 mm	200 mm



HS70F-BF Female Cosmetic Glove with Filler & Bolt

- Adjustable fingers, inner hand foam fillings
- Bolt thread is M12*1.5mm

Article No.	Sizes	A	B	C	E
		Wrist Circ.	Palm Circ.	Middel Finger Length	Length
HS70F-BF-XL	Extra Large	180mm	210mm	80mm	330 mm
HS70F-BF-L	Large	160 mm	195 mm	80 mm	360 mm
HS70F-BF-M	Medium	155 mm	180 mm	70 mm	330 mm
HS70F-BF-S	Small	140 mm	165 mm	68-70 mm	310 mm

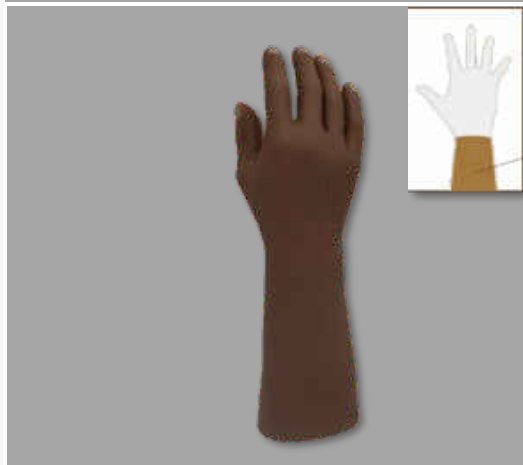

HS70F-XF Female Cosmetic Glove with Filler

- Adjustable fingers, inner hand foam fillings
- With filler only, NO bolt.

Article No.	Sizes	A	B	C	E
		Wrist Circ.	Palm Circ.	Middel Finger Length	Length
HS70F-XF-XL	Extra Large	180mm	210mm	80mm	330 mm
HS70F-XF-L	Large	160 mm	195 mm	80 mm	360 mm
HS70F-XF-M	Medium	155 mm	180 mm	70 mm	330 mm
HS70F-XF-S	Small	140 mm	165 mm	68-70 mm	310 mm

Lower Limb for Children

Knee & Hip Joints

Modular Feet

Modular Components

Lock & Liner

Upper Prost.

Silicon Cosmetic Prost.

Accessories & Materials

Tools

Ortho. Components

Lower Limb for Children

Knee & Hip Joints

Modular Feet

Modular Components

Lock & Liner

Upper Prost.

Silicon Cosmetic Prost.

Accessories & Materials

Tools

Ortho. Components

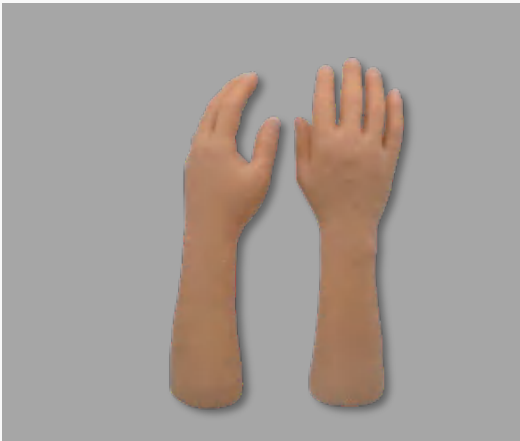

HS70M Male Cosmetic Silicone Glove

Article No.	Sizes	A B C E			
		Wrist Circ.	Palm Circ.	Middel Finger Length	Length
HS70M-XL	Extra Large	190mm	230mm	85mm	360 mm
HS70M-L	Large	180 mm	220 mm	85 mm	360 mm
HS70M-M	Medium	165 mm	200 mm	78-80 mm	330 mm
HS70M-S	Small	155 mm	185 mm	70 mm	310 mm



HS70M-Z Male Cosmetic Glove with Zip & Filler

Article No.	Sizes	A B C E			
		Wrist Circ.	Palm Circ.	Middel Finger Length	Length
HS70M-Z-XL	Extra Large	190mm	230mm	85mm	360 mm
HS70M-Z-L	Large	180 mm	220 mm	85 mm	235 mm
HS70M-Z-M	Medium	165 mm	200 mm	78-80 mm	225 mm
HS70M-Z-S	Small	155 mm	185 mm	70 mm	215 mm



HS70M-BF Male Cosmetic Glove with Filler & Bolt

- Adjustable fingers, inner hand foam fillings,
- Bolt thread is M12*1.5mm

Article No.	Sizes	A B C E			
		Wrist Circ.	Palm Circ.	Middel Finger Length	Length
HS70M-BF-XL	Extra Large	190mm	230mm	85mm	360 mm
HS70M-BF-L	Large	180 mm	220 mm	85 mm	360 mm
HS70M-BF-M	Medium	165 mm	200 mm	78-80 mm	330 mm
HS70M-BF-S	Small	155 mm	185 mm	70 mm	310 mm

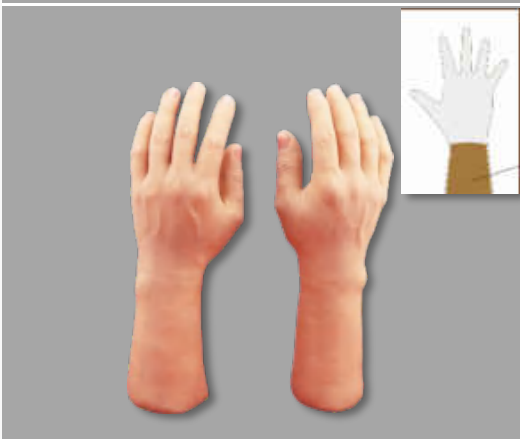

HS70M-XF Male Cosmetic Glove with Filler

- Adjustable fingers, inner hand foam fillings,
- With filler only, NO bolt.

Article No.	Sizes	A B C E			
		Wrist Circ.	Palm Circ.	Middel Finger Length	Length
HS70M-XF-XL	Extra Large	190mm	230mm	85mm	360 mm
HS70M-XF-L	Large	180 mm	220 mm	85 mm	360 mm
HS70M-XF-M	Medium	165 mm	200 mm	78-80 mm	330 mm
HS70M-XF-S	Small	155 mm	185 mm	70 mm	310 mm



HS80M Male Myo./Mechanical Glove

Article No.	Sizes	A	B	C	E
		Wrist Circ.	Palm Circ.	Middel Finger Length	Length
HS80M-XL	Extra Large	190mm	230mm	85mm	360 mm
HS80M-L	Large	180 mm	195 mm	80 mm	325 mm
HS80M-M	Medium	175 mm	190 mm	75 mm	300 mm
HS80M-S	Small	170 mm	180 mm	70 mm	300 mm



HS80F Female Myo./Mechanical Glove

Article No.	Sizes	A	B	C	E
		Wrist Circ.	Palm Circ.	Middel Finger Length	Length
HS80F-XL	Extra Large	190mm	230mm	85mm	360 mm
HS80F-L	Large	175 mm	190 mm	75 mm	305 mm
HS80F-M	Medium	170 mm	180 mm	70 mm	300 mm
HS80F-S	Small	150 mm	170 mm	65 mm	280 mm



HS70-SCM Customized Partial Silicone prostheses

- Male or female, left hand or right hand
- with zip or without zip
- Custom fillings: fillings according to stump shape.
- Custom colorings: we match your required color (according to color swatch number)
- Adjustable fingers
- Need sound hand's and residual hand's dimensions. (refer to Hand Chart.)

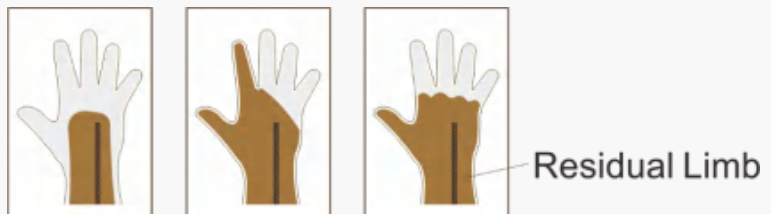

Lower Limb for Children

Knee & Hip Joints

Modular Feet

Modular Components

Lock & Liner

Upper Prost.

Silicon Cosmetic Prost.

Accessories & Materials

Tools

Ortho. Components

- Lower Limb for Children
- Knee & Hip Joints
- Modular Feet
- Modular Components
- Lock & Liner
- Upper Prost.
- Silicon Cosmetic Prost.
- Accessories & Materials
- Tools
- Ortho. Components

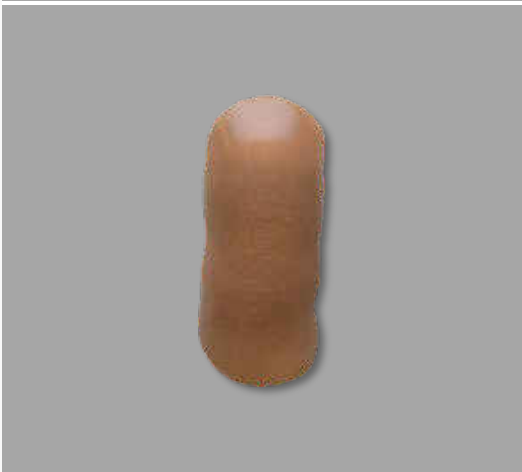
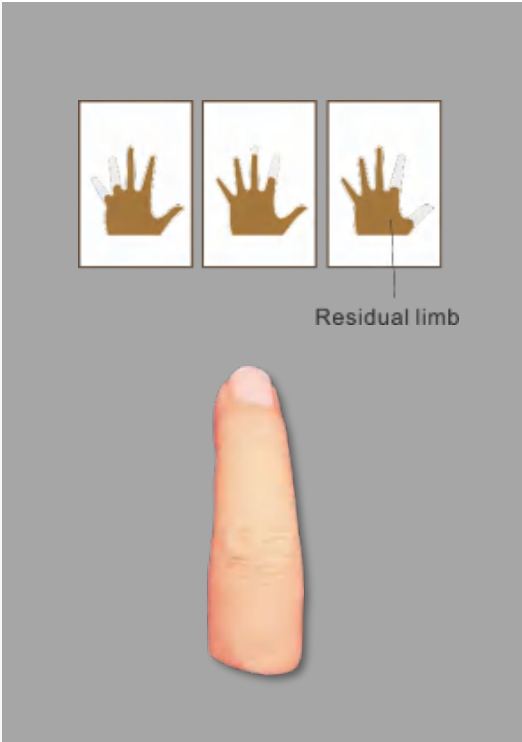

HS200 Standard Silicone Fingers Set

Article No.	Male/Female	Sizes	Middle Finger Length
HS200F-L	Female	Large	80 mm
HS200F-M		Medium	75 mm
HS200F-S		Small	68-70 mm
HS200M-L	Male	Large	85 mm
HS200M-M		Medium	78-80 mm
HS200M-S		Small	70 mm

HS201 Customized Fingers

Article No.	Specifications
HS201	Thumb finger
HS202	Index finger
HS203	Middle finger
HS204	Ring finger
HS205	Little finger

*To make the finger according to the patient residual limb's dimensions.

*Please specify male/female, left/right and color swatch number when ordering.

HS300-SCM Customized Foot Toes

*To make the finger according to the patient residual limb's dimensions.

*Please indicate male/female, left/right and color number when ordering.



1HS10 Standard Silicone Footshell

Article No.	Male/Female	Carbon Plate	Sizes
1HS10F	Female	NO	22-28 cm
1HS10M	Male	NO	22-28 cm
1HS10F-CP	Female	Yes	22-28 cm
1HS10M-CP	Male	Yes	22-28 cm

*Upgrade option: Carbon fiber energy restoring footplate



1HS10-Z Standard Silicone Footshell with Zip

Article No.	Male/Female	Carbon Plate	Sizes
1HS10F-Z	Female	NO	22-28 cm
1HS10M-Z	Male	NO	22-28 cm
1HS10F-Z-CP	Female	Yes	22-28 cm
1HS10M-Z-CP	Male	Yes	22-28 cm

*Upgrade option: Carbon fiber energy restoring footplate

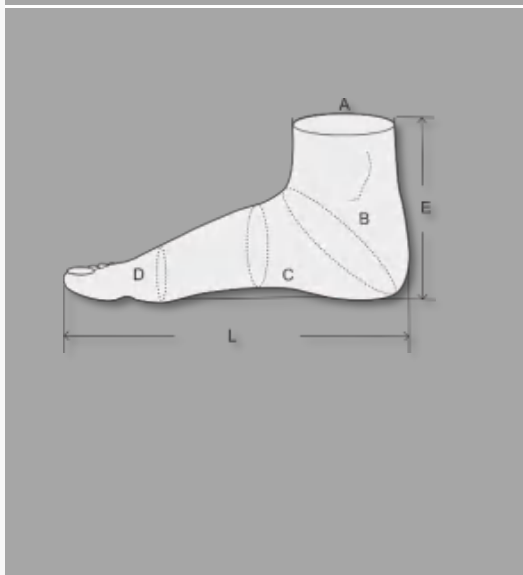

1HS10-SCM Customized Foot

- Please specify when placing an order:
 - (1) male or female;
 - (2) foot size--foot length;
 - (3) Color number;
 - (4) to measuring dimensions/girth of A/B/C/D and E height.



14HE20 Silicone Cosmetic Ear

- Please contact us, when you need more information.

Lower Limb for Children

Knee & Hip Joints

Modular Feet

Modular Components

Lock & Liner

Upper Prost.

Silicon Cosmetic Prost.

Accessories & Materials

Tools

Ortho. Components

Silicon Cosmetic Products

Lower Limb for Children

Knee & Hip Joints

Modular Feet

Modular Components

Lock & Liner

Upper Prost.

Silicon Cosmetic Prost.

Accessories & Materials

Tools

Ortho. Components

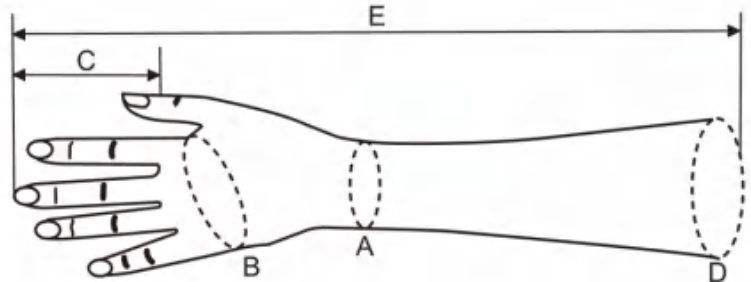
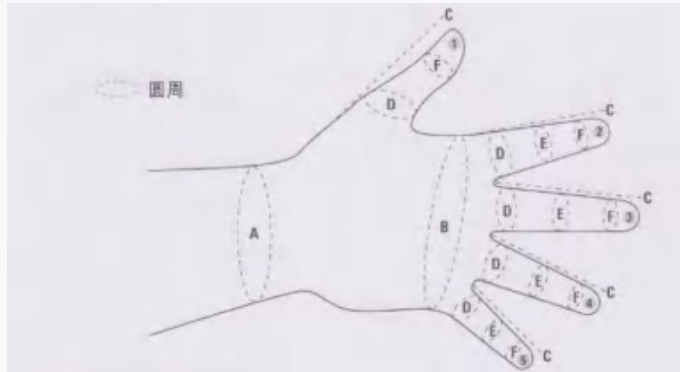
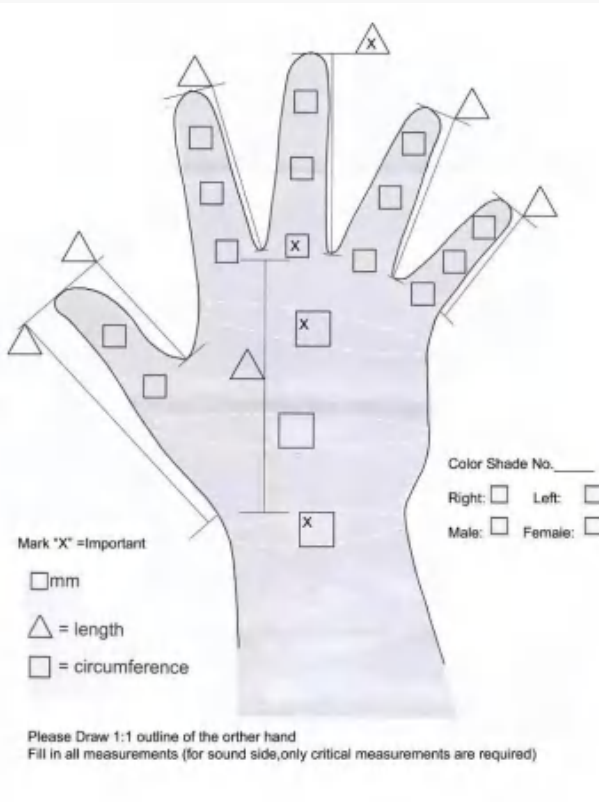

Accessories and Materials



6R20 AK Molded Foam Cover

PU foam material, good surface, skin feeling.

Article No.	Upper Cir.	Calf Cir.	Length
6R20-L	59 cm	38±0.5 cm	88 cm
6R20-M	57 cm	36.5±0.5 cm	85 cm
6R20-S	56 cm	35±0.5 cm	85 cm

*Please specify Left or right when ordering.

6R21 AK Water-proof Cover

Material: EVA foam.

Article No.	Upper Cir.	Calf Cir.	Length
6R21-L	59 cm	37-38 cm	85 cm
6R21-M	58 cm	35-36 cm	83 cm
6R21-S	56 cm	33-34 cm	80 cm
6R21-CH	46 cm	30 cm	65 cm

*6R21-CH is for Children use.

6R23 AK Foam Cover

PUR flexible foam material, pre-shaped

Article No.	Upper Cir.	Calf Cir.	Length
6R23-L	72-73 cm	43-44 cm	85 cm
6R23-M	67-68 cm	39-40 cm	85 cm
6R23-S	67-68 cm	36-37 cm	85 cm

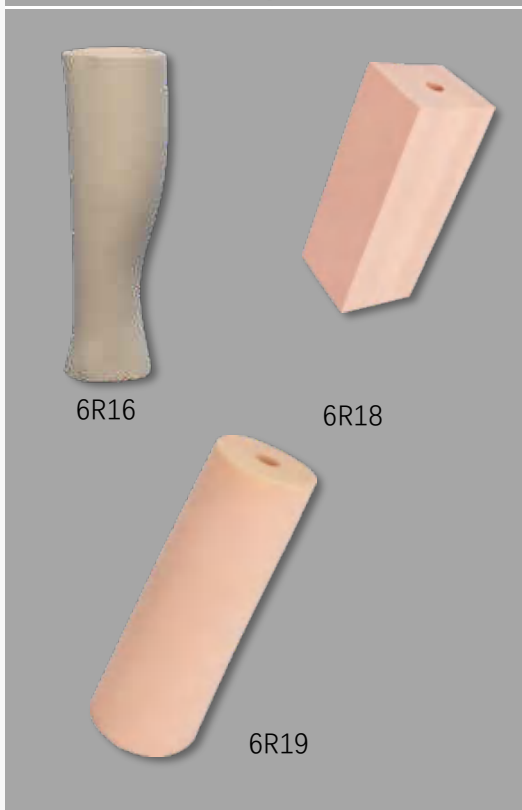

6R16 BK Water-proof Cover

Material: EVA foam material.

Article No.	Upper Cir.	Calf Cir.	Length
6R16-L	40 cm	36-37 cm	43 cm
6R16-M	38 cm	34-35 cm	43 cm
6R16-S	36 cm	32-33 cm	43 cm
6R16-CH	32 cm	28 cm	35 cm

* 6R16-CH is for Children use.

6R18 BK Foam Cover

Material: EVA foam material.

Article No.	Dimensions	Hole
6R18	16*13*L43cm	Φ 30 mm

6R19 BK Foam Cover

Material: PUR foam material.

Article No.	Dimensions	Hole
6R19	Φ 16*L43cm	Φ 30 mm

Lower Limb for Children

Knee & Hip Joints

Modular Feet

Modular Components

Look & Liner

Upper Prost.

Silicon Cosmetic Prost.

Accessories & Materials

Tools

Ortho. Components

Lower Limb for Children

Knee & Hip Joints

Modular Feet

Modular Components

Lock & Liner

Upper Prost.

Silicon Cosmetic Prost.

Accessories & Materials

Tools

Ortho. Components



99B16 Perlon Cosmetic Stocking

- Two colors available: Brown and Beige

Article No.	Used For	Length/width
99B16	BK prosthesis	46/10 cm
99B14	AK prosthesis	56/11 cm



99B26 Perlon Cosmetic Stocking

- Bend at stocking's heel.
- Beige color only.

Article No.	Used For	Length/width
99B26	BK prosthesis	19+29 cm
99B24	AK prosthesis	19+53 cm

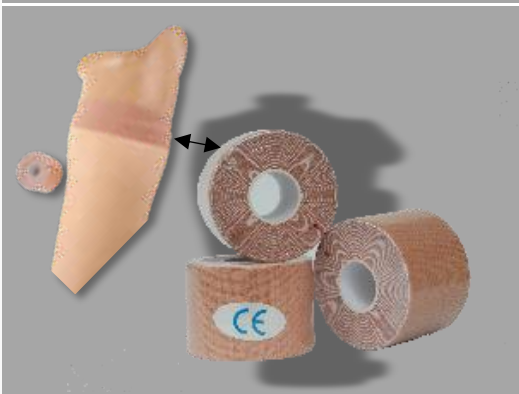

503A50 Adhesive Tape

- For fixing cosmetic stocking/foam cover upon socket.
- Length: 50 meter
- Width: 50 mm



21ES10 Easy Donny Sleeve

Article No.	Proximal Cir.	Distal Cir.
21ES10-XS	40 cm	12 cm
21ES10-S	41-50 cm	13 cm
21ES10-M	46-58 cm	14 cm
21ES10-L	59-70 cm	15 cm
21ES10-XL	71-80 cm	16 cm
21ES10-XXL	81- cm	17 cm



21B37 AK Suspension Sleeve

Article No.	Sizes	Sides	F. Hip Cir.	Socket Cir.
21B37-L1	S-size	left	60-74 cm	36-40 cm
21B37-R1	S-size	right	60-74 cm	36-40 cm
21B37-L2	M-size	left	66-80 cm	40-44 cm
21B37-R2	M-size	right	66-80 cm	40-44 cm
21B37-L3	L-size	left	76-90 cm	44-48 cm
21B37-R3	L-size	right	76-90 cm	44-48 cm
21B37-L4	XL-size	left	86-100 cm	48-52 cm
21B37-R4	XL-size	right	86-100 cm	48-52 cm
21B37-L5	XXL-size	left	96-110 cm	52-56 cm
21B37-R5	XXL-size	right	96-110 cm	52-56 cm

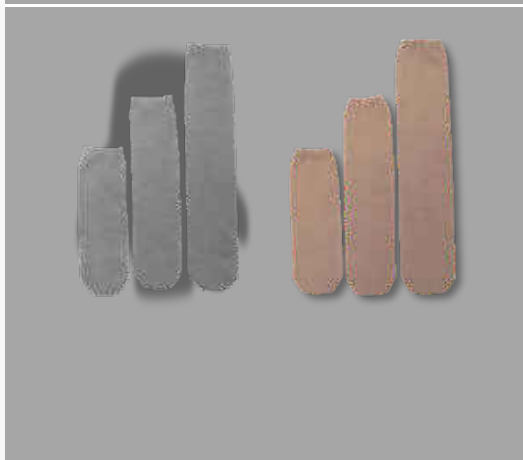

501F3 Cotton Stump Sock

- Two colors available: Beige and Grey

Article No.	Length	Width
501F3-30	30 cm	10 cm
501F3-40	40 cm	11 cm
501F3-50	50 cm	11 cm



501U3 Nylon Stump Sock

- Beige color only.

Article No.	Length	Width
501U3-30	30 cm	8.5 cm
501U3-40	40 cm	8.5 cm
501U3-50	50 cm	8.5 cm



501T3 Terry Cotton Stump Sock

- more soft and comfortable.
- Two colors available: White and Grey

Article No.	Length	Width
501T3-30	30 cm	9.5 cm
501T3-40	40 cm	9.5 cm
501T3-50	50 cm	9.5 cm

Lower Limb for Children



21PF PVA Film

- Thickness 0.08 mm

Article No.	Width	Length	Weight
21PF-100	100 cm	100 meter	12.5 kg
21PF-50	100 cm	50 meter	6.3 kg

Knee & Hip Joints



21P20 PVA Lamination Bag

Article No.	Length	Width A	Width B
21P20-1	100 cm	50 cm	4 cm
21P20-2	100 cm	50 cm	4 cm
21P20-3	100 cm	35 cm	5 cm
21P20-4	100 cm	30 cm	5 cm
21P20-5	100 cm	25 cm	5 cm
21P20-6	100 cm	20 cm	5 cm
21P20-7	100 cm	15 cm	5 cm
21P20-8	100 cm	10 cm	4 cm
21P20-9	70 cm	15 cm	5 cm
21P20-10	50 cm	13 cm	4 cm

* Package: 10 pcs each package

Modular Feet

Modular Components

Lock & Liner



6T2 Socket Cone (BK)

- EVA foam. Thickness: 6 mm

Article No.	Upper Inner Dia	Lower Inner Dia	Length
6T2-S	13 cm	7.6 cm	41 cm
6T2-M	14.5 cm	8.3 cm	43 cm
6T2-L	16.5 cm	8.8 cm	50 cm

Upper Prost.

Silicon Cosmetic Prost.

Accessories & Materials



6T1 Socket Cone (AK)

- EVA foam. Thickness: 6 mm

Article No.	Upper Inner Dia	Lower Inner Dia	Length
6T1-S	57 cm	40.5 cm	37.5 cm
6T1-M	59.5 cm	41.5 cm	49.5 cm
6T1-L	61.5 cm	39.5 cm	47.5 cm
6T1-XL	67 cm	39 cm	50.5 cm

Tools

Ortho. Components



22CF Fiberglass Cloth

Article No.	Width	Package
22CF-3K	100 cm	Pack to order
22CF-5	5 cm	



23CF Carbon Fiber Stockinette

Article No.	Size/width	Package
23CF-S	5 cm	10 meter/roll
23CF-9	9 cm	10 meter/roll
23CF-12	12cm	10 meter/roll
23CF-15	15 cm	10 meter/roll

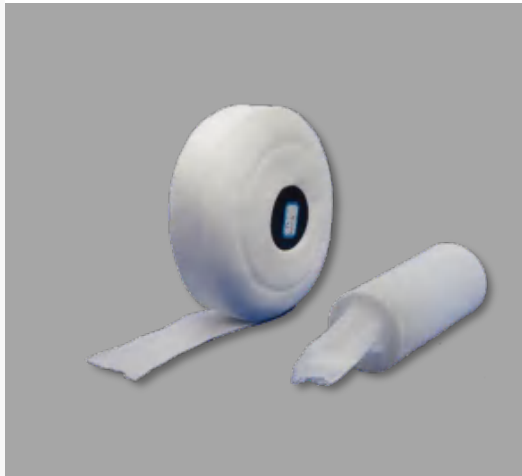

29NL Nylon Stockinette

- Used for internal and external surface of lamination socket, smooth surface and good looking.
- Suggestion: 2-3 layers for internal socket and for external socket.
- Width-6cm used for upper prosthetics
- width-8cm for BK prosthetics
- width-12cm for Ak prosthetics

Article No.	width	Package	Approx. meters/kg
29NL-6	6 cm	0.3 kg/roll	190
29NL-9	9 cm	0.5 kg/roll	128
29NL-12	12 cm	1.0 kg/roll	85



24FG Fiberglass Stockinette

Article No.	width	Package	Approx. meters/kg
24FG-1	10 cm	1 kg/roll	29
24FG-2	13/16/18/20/22/25 cm	2 kg/roll	23/18/16



25PL Perlon Stockinette

Article No.	width	Package	Approx. meters/kg
25PL-1	4/5/6/8/9/10 cm	1 kg/roll	53/47/39/29/26/24
25PL-2	13/15/18/20 cm	2 kg/roll	20/16/13/12
25PL-3	22/25/30/35 cm	3 kg/roll	11/9.5/8/6.8



26CT Cotton Stockinette

Article No.	width	Package	Approx. meters/kg
26CT-1	4/5/6/8/9/10 cm	1 kg/roll	53/47/39/29/26/24
26CT-2	13/15/18/20 cm	2 kg/roll	20/16/13
26CT-3	22/25/30/35 cm	3 kg/roll	12/11/9.5/8/6.8

Lower Limb for Children

Knee & Hip Joints

Modular Feet

Modular Components

Look & Liner

Upper Prost.

Silicon Cosmetic Prost.

Accessories & Materials

Tools

Ortho. Components

Lower Limb for Children



Knee & Hip Joints

Modular Feet



Modular Components



Lock & Liner



Upper Prost.



Silicon Cosmetic Prost.



Accessories & Materials



Tools



Ortho. Components

21VR551 Expulsion Valve

- The Valve 551 is an auto-expulsion & push button suction release in the same compact, easy to install. The valve is recommended for both Transtibial and Transfemoral users.

Article No.	Thread-Φ	Body-Φ	Material
21VR551	10 mm	26 mm	Alu.& Plastic

21VR552 Expulsion Valve

- The Valve 552 is an auto-expulsion valve with push button for suction release. The core of the valve can be unscrewed facilitate rapid donning and it makes it possible to pull donning socks through the valve. The valve can be used with a flexible interface and is recommended for Transfemoral users.

Article No.	Hole-Φ	Socket hole-Φ	Material
21VR552	25 mm	32 mm	Alu.& Plastic

21VH01 Button Valve

- Housing Diameter: Φ 38 mm
- The housing is temperature resistant up to 200°
- The Valve 21VH01 is a valve with push button for suction release. The core of the valve can be unscrewed facilitate rapid donning and it makes it possible to pull donning socks through the valve. The valve is recommended for Transfemoral users.

21VH02 Auto Valve

- Housing Diameter: Φ 38 mm
- The housing is temperature resistant up to 200°
- The Valve 21VH02 is an auto-expulsion valve with push button for suction release. The core of the valve can be unscrewed facilitate rapid donning and it makes it possible to pull donning socks through the valve. The valve is recommended for Transfemoral users.

21V15 Auto Valve

- The Valve 21VH15 is an auto-expulsion valve with push button for suction release. The valve is recommended for Transfemoral users.
- With thump flap, without seat ring

Article No.	Outside-Φ	For Seat ring-Φ	Material
21V15	Φ 40 mm	Φ 24 mm	Rubber

* Assembling with valve seat 21VS10 or 21VS20



21V03 Flat Rubber Valve

- With thump flap, without seat ring

Article No.	Outside- Φ	For Seat ring- Φ	Material
21V03	Φ 40 mm	Φ 24 mm	Rubber

* Assembling with valve seat 21VS10 or 21VS20



21VS10 Valve Seat with Tube

- For valve with 40 mm outside- Φ .

Article No.	Outside- Φ	For Seat ring- Φ	Material
21VS10	24 mm	28 mm	PVC



21VS20 Valve Seat Ring

- For valve with 40 mm outside- Φ .

Article No.	Outside- Φ	For Seat ring- Φ	Material
21VS20	24 mm	28 mm	PVC



27ES EVA Sheet

- EVA material, Hardness Shore-C60°/Shore-C35° ($\pm 2^\circ$)
- TWO color available: beige an brown
- Thermo-plastically moldable temperature approx. 140°C-160°C

Article No.	Thickness	Width	length	Hardness
27ES-5	5 mm	100 cm	150cm	60°
27ES-6	6 mm	100 cm	150cm	60°
27ES-10	10 mm	100 cm	150cm	35°

Lower Limb for Children

Knee & Hip Joints

Modular Feet

Modular Components

Look & Liner

Upper Prost.

Silicon Cosmetic Prost.

Accessories & Materials

Tools

Ortho. Components

Accessories & Materials

Lower Limb for Children

Knee & Hip Joints

Modular Feet

Modular Components

Lock & Liner

Upper Prost.

Silicon Cosmetic Prost.

Accessories & Materials

Tools

Ortho. Components



36VBL Velcro Belt with Buckle

- The inner surface is sewn with Velcro loop strap and Velcro hook strap.
- Five colors available. Total length can be made to order.

Article No.	Width	Length	Material
36VBL-20	20 mm	20-25cm	Microfiber
36VBL-25	25 mm	25-30cm	
36VBL-38	38 mm	35-40cm	

*Please specify Color Number when ordering.

37CMP Comfort Pad

- Option product. Used with Velcro belt with buckle 36VBL.
- Soft/comfort, skin care/pressure-free.
- Five colors available.

Article No.	Width of Belt	Width*Length	Material
37CMP-20	20 mm	4.0*8.0 cm	Microfiber
37CMP-25	25 mm	4.5*8.5 cm	
37CMP-38	38 mm	5.3*13.3 cm	

*Please specify Color Number when ordering.

38VBF Velcro Belt with Buckle

- Inner surface of the fabric strap is sewn with Velcro loop strap. And there is a 2mm thick foam tape inside the strap.
- Soft/comfort, skin care/pressure-free.
- Eight colors available. Total length can be made to order.

Article No.	Width	Width*Length	Material
38VBF-25	25 mm	28 cm	Velcro fabric & foam
38VBF-38	38 mm	38 cm	

*Please specify Color Number when ordering.

34TNB Triangle Nylon Buckle

- Eight colors available.

Article No.	Width	Material	Weight
34TNB-20	20 mm	Nylon & metal	2.1 g
34TNB-25	25 mm	Nylon & metal	4.2 g
34TNB-38	38 mm	Nylon & metal	9.6 g

*Please specify Color Number when ordering.

35TNB Triangle Nylon Buckle

- Four colors available.

Article No.	Width	Material	Weight
35TNB-25	25 mm	Nylon	2.5 g
35TNB-38	38 mm	Nylon	5.5 g

*Please specify Color Number when ordering.





41ADV Adhesive Elastic Strap

- Back surface of the straps are with glue. Excellent ductility.
- Used to wrap the edges of rehabilitation AIDS.
- Colors: Beige

Article No.	Width	Length	Material
41ADV-25	25 mm	25 meters	Nylon Fabric
41ADV-30	30 mm	25 meters	Nylon Fabric



42SRC Sunk Head Rivet

- Head Φ : 10.5 mm.

Article No.	Width	Length	Material
42SRC-410	4 mm	10 mm	Red bronze
42SRC-413	4 mm	13 mm	Red bronze
42SRC-416	4 mm	16 mm	Red bronze
42SRC-420	4 mm	20 mm	Red bronze



43SRA Sunk Head Rivet

- Head Φ : 10.5 mm.

Article No.	Width	Length	Material
43SRA-413	4 mm	13 mm	Aluminum
43SRA-416	4 mm	16 mm	Aluminum
43SRA-420	4 mm	20 mm	Aluminum



44DCR Double Caps Rivet

Article No.	Dimension	Hole Φ	Material
44DCR-1008	Φ 10x08 mm	3.0 mm	Nickle-plated iron
44DCR-1010	Φ 10x10 mm	3.0 mm	
44DCR-1210	Φ 12x10 mm	3.5 mm	
44DCR-1212	Φ 12x12 mm	3.5 mm	



50SCR Single Cap Rivet

Article No.	Dimension	Hole Φ	Material
50SCR-1008	Φ 10x8 mm	3.0 mm	Nickle-plated iron
50SCR-1010	Φ 10x10 mm	3.0 mm	
50SCR-1210	Φ 12x10 mm	3.5 mm	
50SCR-1211	Φ 12x11 mm	3.5 mm	
50SCR-1212	Φ 12x12 mm	3.5 mm	

Lower Limb for Children

Knee & Hip Joints

Modular Feet

Modular Components

Look & Liner

Upper Prost.

Silicon Cosmetic Prost.

Accessories & Materials

Tools

Ortho. Components

- Lower Limb for Children
- Knee & Hip Joints
- Modular Feet
- Modular Components
- Lock & Liner
- Upper Prost.
- Silicon Cosmetic Prost.
- Accessories & Materials
- Tools
- Ortho. Components



623TP11-1



623TP11-2



623TP11-3



623TP11-4



623TP11-5



623TP11-6



623TP11-7



623TP11-8

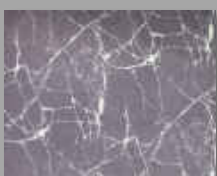

623TP11-9



623TP11-10

623TP11-1 Thermal paper

- For dyeing sheet materials.

Article No.	Pictures	Length * width
623TP11-1	Triangles	2000x600 mm
623TP11-2	Water drop	2000x600 mm
623TP11-3	Water drop	2000x600 mm
623TP11-4	Carbon fiber	3000x400 mm
623TP11-5	flower	3000x400 mm
623TP11-6	Camouflage	3000x400 mm
623TP11-7	Ink Paint	3000x400 mm
623TP11-8	Strawberry	3000x400 mm
623TP11-9	Marbling	3000x400 mm
623TP11-10	Butterfly	3000x400 mm

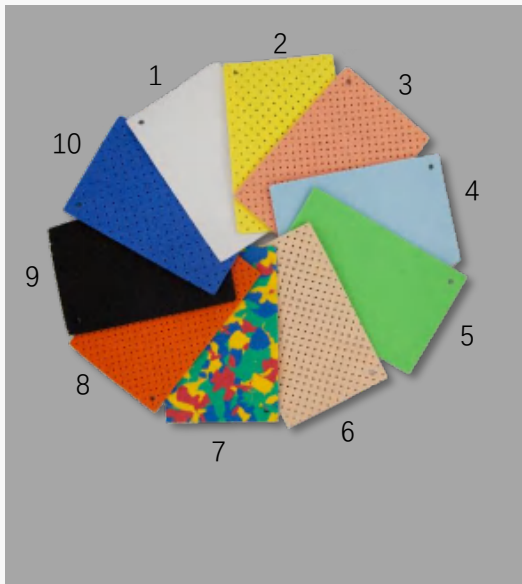

28MP Multicolor Soft Sheet

- EVA material, Hardness Shore-A40°/Shore-C63°(±2°)
- Thermo-plastically moldable temperature approx.: 100°C--140°C.
- TEN color available, marked color number.
- Two kinds: perforated / without perforated

Article No.	Thickness	Width/Length	Perforated
28MP2	2 mm	100 * 140 cm	without perforated
28MP2-P	2 mm	100 * 140 cm	perforated
28MP3	3 mm	100 * 140 cm	without perforated
28MP3-P	3 mm	100 * 140 cm	perforated
28MP4	4 mm	100 * 140 cm	without perforated
28MP4-P	4 mm	100 * 140 cm	perforated

* Please specify COLOR Number when placing order.

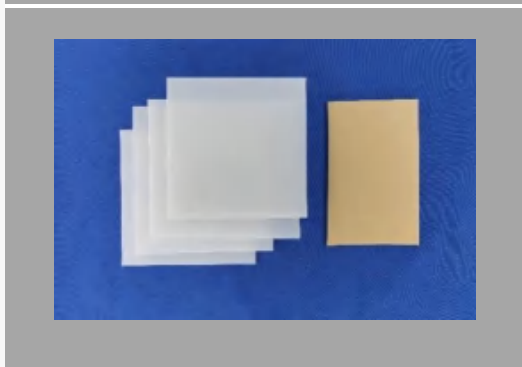

41PES Thermoplastic Sheet (Polyethylene)

- Two colors: Beige and white

Article No.	Thickness	Width/Length
41PES-3	3 mm	1200x2000mm
41PES-4	4 mm	1200x2000mm
41PES-5	5 mm	1200x2000mm

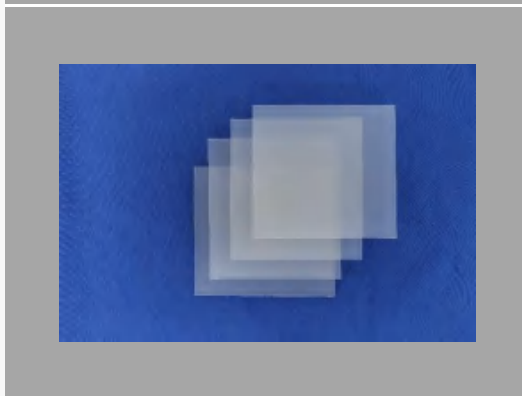

42PPS Thermoplastic Sheet (Polyethylene)

- Colors: transparent with milky

Article No.	Thickness	Width/Length
42PPS-3	3 mm	1000x2000mm
42PPS-4	4 mm	1000x2000mm
42PPS-5	5 mm	1000x2000mm

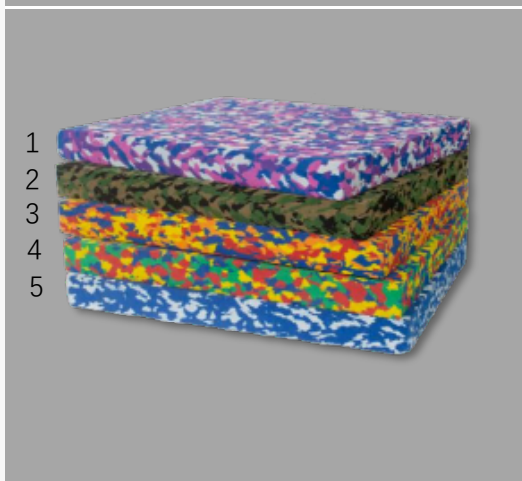

28MP30 EVA Sheet for Arch Insole Pad (Multicolor)

- EVA material, For Foot orthosis use.
- Width-26cm, Length-33cm

Article No.	Color No.	Thickness	Hardness Available
28MP30-1	Color 1#	30 mm	Shore-C60/C75/80
28MP30-2	Color 2#	30 mm	Shore-C65
28MP30-3	Color 3#	30 mm	Shore-C55/C65/70/75
28MP30-4	Color 4#	30 mm	Shore-C65/C70/75
28MP30-5	Color 5#	30 mm	Shore-C55/65/70/75/80

*Normally Dimension 330*260mm can be used for one pair pad.

*Maximum sizes available are as below:

*140cm*100cm for Shore C75-C80 plate,

*150cm*100 for Shore C60-C70 plate,

*160cm*100cm for Shore C50-C55 plate.

Lower Limb for Children

Knee & Hip Joints

Modular Feet

Modular Components

Lock & Liner

Upper Prost.

Silicon Cosmetic Prost.

Accessories & Materials

Tools

Ortho. Components



28MC30 EVA Sheet for Arch Insole Pad (Monochrome)

- EVA material, For Foot orthosis use.
- Width-26cm, Length-33cm

Article No.	Color	Thickness	Hardness Available
28MC30-NO	Dark Blue	30 mm	Shore-C 60/65/70/75/80°
28MC30-WH	White	30 mm	Shore-C70°
28MC30-LB	Light Blue	30 mm	Shore-C55/75/50°
28MC30-GN	Green	30 mm	Shore-C70°
28MC30-PK	Pink	30 mm	Shore-C50°
28MC30-YL	Yellow	30 mm	Shore-C50°
28MC30-DG	Dark Gray	30 mm	Shore-C75°
28MC30-RD	Red	30 mm	Shore-C65~70°
28MC30-ST	Skin Tone	30 mm	Shore-C60°

*Please specify Color Number when ordering.

*Custom-made Dimension (Length * Width) can be supplied.

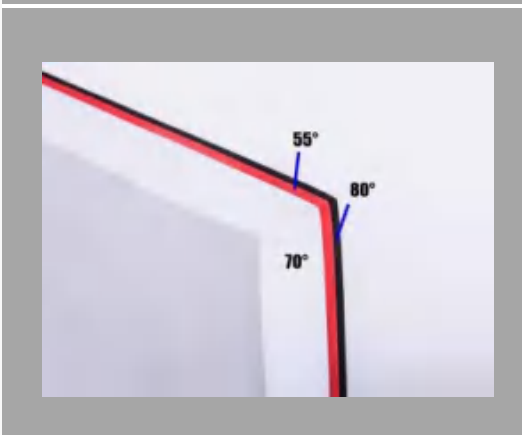

28TH30 EVA Sheet for Arch Insole Pad (Tri-Layer)

- EVA material, For Foot orthosis use.
- Width-26cm, Length-33cm, total thickness-30mm

Article No.	Thickness	Hardness Available
28TH30	White-23 mm	White/Shore-C75°
	Red-4 mm	Red/Shore-C55°
	Black-3 mm	Black/Shore-C80°

*Please specify Color Number when ordering.

*Custom-made Dimension (Length * Width) can be supplied.



31MLS Velcro Loop Strap

- Nylon material.
- Eight colors available. Package: One roll.

Article No.	Width	Length	Hook/Loop
31MLS-25	25 mm	25 meters	Loop
31MLS-38	38 mm	25 meters	Loop

*Please specify Color Number when ordering.



32MHS Velcro hook Strap

- Nylon material.
- Eight colors available. Package: One roll.

Article No.	Width	Length	Hook/Loop
32MHS-25	25 mm	25 meters	Hook
32MHS-38	38 mm	25 meters	Hook

*Please specify Color Number when ordering.



33ADV Adhesive Velcro Hook Strap

- Back surface of the straps are with glue.
- Two colors available: White and Black

Article No.	Width	Length	Material
33ADV-25	25 mm	25 meters	Nylon
33ADV-38	38 mm	25 meters	Nylon

*Please specify Color Number when ordering.



40BFS Brushed Fabric Straps

- Its double surfaces can be stucked with Velcro hook.
- Three colors: Grey ,Black and Blue color.

Article No.	Width	Length	Material
40BFS-20	20 mm	25 meters	Brushed chemical fabric
40BFS -25	25 mm	25 meters	
40BFS -38	38 mm	25 meters	
40BFS -50	50 mm	25 meters	

*Please specify Color Number when ordering.



39VFS Velcro Fabric Strap

- Inner surface of the fabric strap is sewn with Velcro loop strap. And there is a 2mm thick foam tape inside the strap.
- Soft/comfort, skin care/pressure-free.
- Eight colors available. Package: One roll.

Article No.	Width	Length	Material
39VFS-25	25 mm	25 meter	Velcro fabric & foam
39VFS-38	38 mm	25 meter	

*Please specify Color Number when ordering.

Lower Limb for Children

Knee & Hip Joints

Modular Feet

Modular Components

Look & Liner

Upper Prost.

Silicon Cosmetic Prost.

Accessories & Materials

Tools

Ortho. Components

Lower Limb for Children

Knee & Hip Joints

Modular Feet

Modular Components

Lock & Liner

Upper Prost.

Silicon Cosmetic Prost.

Accessories & Materials

Tools

Ortho. Components

Tools



743A11 Casting Apparatus (without handrail)

743A11A Casting Apparatus with handrail

- For functional casting during weight bearing
- with steady base plate
- Easy height adjustment
- **Dimension:**
W*L*H: 80x60x110 cm
Weight: 32 kgs
- **Casting rings:**
plastic material
Three dimensions, diameters inside: \varnothing 105/ \varnothing 115/ \varnothing 130 mm



743A15 Casting Apparatus with handrail

- For functional casting during weight bearing
- with steady base plate
- Easy height adjustment
- Handrail height: 93--150 cm
- **Dimension:**
W*L*H: 92x70x93 cm
Weight: 42 kgs
- **Casting rings:**
plastic material
Three dimensions, diameters inside: \varnothing 105/ \varnothing 115/ \varnothing 130 mm



711S1 Bending Iron

- With flat tines.

Article No.	Mouth Opening	Length
711S1-6x4	4 and 6 mm	250 mm
711S1-8x6	6 and 8 mm	250 mm
711S1-9x7	7 and 9 mm	250 mm

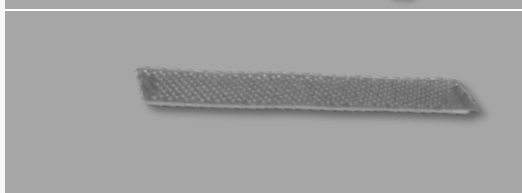

716Y1 Surform Blade, Flat

- Length:250 mm, Weight:40g

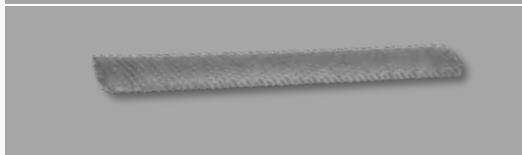

716Y3 Surform Blade, Flat-Round

- Length:250 mm, Weight:40g



716Y4 Surform Blade, Rounded

- Length:250 mm, Weight:35g



718H12 Fuchs Draw Knife

- Steel blade, with wooden handles

Article No.	Length	Bred width
718H12	250 mm	25 mm

719G6 Undulate Scissor

- Optimal for cutting of silicone liners up to 10mm material thickness with or without textile cover.
- Gentle rounding of cutting edges to avoid sections and crack.

Article No.	Length	Undulate width
719G6	235 mm	10 mm



756E1 Hand Sealing Iron

- for sealing PVC and PVA sheeting
- Temperature control, heating surface covered with Teflon sheet.
- with 1.2 meter power cord with grounded plug.
- Temperature Range: 50°C-250°C
- Power Requirement: V/KW220/50-60Hz, or/KW110/50-60Hz



749F Sanding Drum

Article No.	Specifications	Thread
749F6	Φ 72.5* L200 mm	
749Z7- M16	Φ 50 * L70 mm	M16
749Z7- 5/8		5/8"
749Z22- M16	Φ 25 * L40 mm	M16
749Z22- 5/8		5/8"



749Y Sanding Sleeve

Article No.	Specifications	For
749Y8	Φ 72.5* L200 mm	749F6
749Y16	Φ 50 * L70 mm	749Z7
749Y22	Φ 25 * L40 mm	749Z22

Lower Limb for Children

Knee & Hip Joints

Modular Feet

Modular Components

Lock & Liner

Upper Prost.

Silicon Cosmetic Prost.

Accessories & Materials

Tools

Ortho. Components

Lower Limb for Children

Knee & Hip Joints

Modular Feet

Modular Components

Lock & Liner

Upper Prost.

Silicon Cosmetic Prost.

Accessories & Materials

Tools

Ortho. Components



749Z9 Conical Sanding Drum

- Tool steel mandrel, rubber core
- complete with one sanding sleeve.

Article No.	Specifications	Thread
749Z9-M16	Φ 36/Φ 22mm	M16
749Z9-5/8	Length 60 mm	5/8"

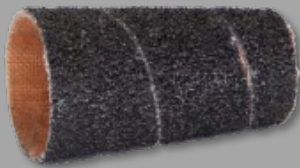

749Y26 Sanding Sleeve

- For 749Z9 Sanding drum
- Three grits available: 60#,80# and 100#



729W3-2
729W5-2



729W3-4
729W5-4



729W3-5
729W5-5



702K7-40
702K8-40



702K7-60
702K8-60

729W3 Rasp Head

- Tool steel, for wood and rigid foam plastic, rough cut.

Article No.	Thread	Rasp Diameter	Rasp Length	Total Length
729W3-2	M16	Φ 50mm	60mm	75mm
729W5-2	5/8"			
729W3-4	M16	Φ 36mm	50mm	60mm
729W5-4	5/8"			
729W3-5	M16	Φ 28mm	75mm	90mm
729W5-5	5/8"			
702K7-40	M16	Φ 40mm	36mm	65mm
702K8-40	5/8"			
702K7-60	M16	Φ 60mm	52mm	70mm
702K8-60	5/8"			



729F3-2



729F3-4



729F3-5

729F3 Rasp Head

- Emery material on surface.

Article No.	Thread	Rasp Diameter	Rasp Length	Total Length
729F3-2	M16	Φ 50mm	60mm	75mm
729F5-2	5/8"			
729F3-4	M16	Φ 36mm	50mm	60mm
729F5-4	5/8"			
729F3-5	M16	75mm	75mm	90mm
729F5-5	5/8"			

Lower Limb for Children

Knee & Hip Joints

Modular Feet

Modular Components

Lock & Liner

Upper Prost.

Silicon Cosmetic Prost.

Accessories & Materials

Tools

Ortho. Components

Orthotic Components

Lower Limb for Children

Knee & Hip Joints

Modular Feet

Modular Components

Lock & Liner

Upper Prosti.

Silicon Cosmetic Prosti.

Accessories & Materials

Tools

Ortho. Components

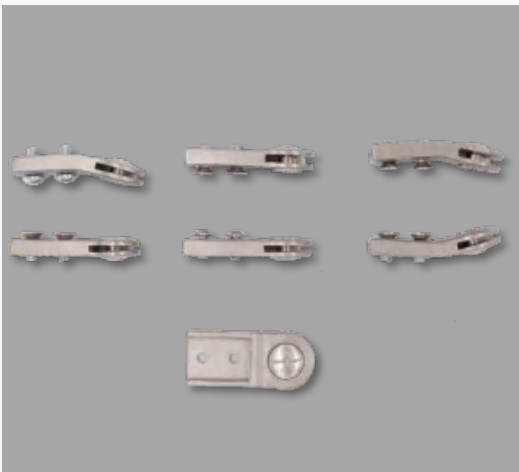

15WJA/B/C Ankle Joint

- Weight:1300g, Material: stainless steel.

Article No.	For Bar	Specification	Left/Right
15WJA-20L	20 mm	Straight & contoured	Left
15WJA-20R			Right
15WJA-16L	16 mm	Straight & contoured	Left
15WJA-16R			Right
15WJB-20L	20 mm	Straight & Straight	Left
15WJB-20R			Right
15WJB-16L	16 mm	Straight & Straight	Left
15WJB-16R			Right
15WJLC-20L	20 mm	contoured & contoured	Left
15WJC-20R			Right
15WJLC-16L	16 mm	contoured & contoured	Left
15WJC-16R			Right

15DH Double Action Ankle Hinge

- The hinge can be changed to two-way or one-way resistance or assisted movements in direction of plantar flexion or dorsiflexion of ankle joint by adjusting support pillar and spring.

Article No.	Length	For Bar	Material
15DH-L	350 mm	5x19 mm	Stainless Steel
15DH-M	300 mm	4x17 mm	Stainless Steel
15DH-S	200 mm	3x13 mm	Stainless Steel

*15DH hinge DO NOT include bars.

15DP Double Action Ankle Hinge

- The hinge can be changed to two-way or one-way resistance or assisted movements in direction of plantar flexion or dorsiflexion of ankle joint by adjusting support pillar and spring.

Article No.	Size	Product Weight	Material
15DP-L	L-size	134 g	Stainless Steel
15DP-S	S-size	95 g	Stainless Steel

15EA Elastomer AFO Joint

Article No.	Size	Two holes spacing	Material
15EA-L	L-size	29.5 mm	High polymer
15EA-S	S-size	17.5 mm	High polymer

15FA Free Motion Ankle Joint

- Designed to prevent the abnormal movements of subtalar joint which has the varus or a valgus deformity.

Article No.	Size	Two holes spacing	Material
15FA-L	L-size	59 mm	Stainless Steel
15FA-S	S-size	43 mm	Stainless Steel

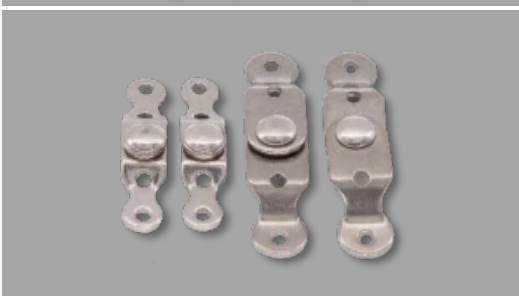
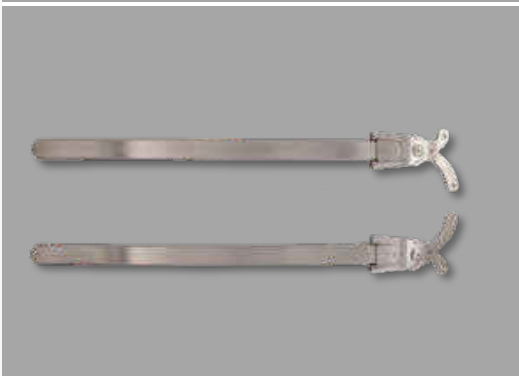

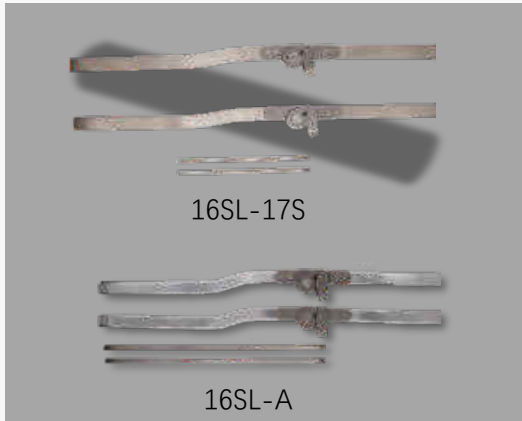

16SL Swiss Lock Hinge with Self-locking & Stick

Article No.	Specification	width	Weight	Material
16SL-19S	840*19*4 mm	19 mm	1350 g	Stainless Steel
16SL-16S	840*16*4 mm	16 mm	1050 g	Stainless Steel
16SL-19A	840*19*6 mm	19 mm	850 g	Aluminum
16SL-17A	840*17*6 mm	17 mm	730 g	Aluminum

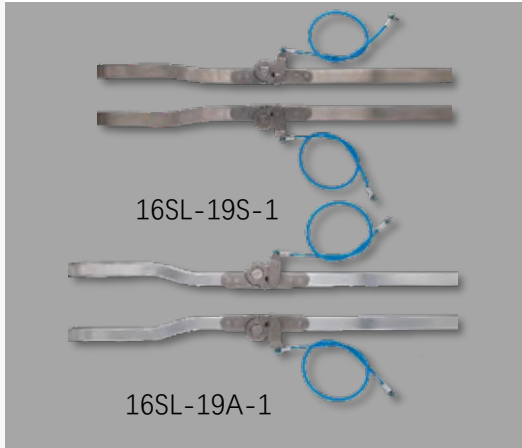

16SL-1 Swiss Lock Hinge with Self-locking

Article No.	Specification	width	Weight	Material
16SL-19S-1	840*19*4 mm	19 mm	1340 g	Stainless Steel
16SL-16S-1	840*16*4 mm	16 mm	1040 g	Stainless Steel
16SL-19A-1	840*19*6 mm	19 mm	840 g	Aluminum
16SL-17A-1	840*17*6 mm	17 mm	720 g	Aluminum

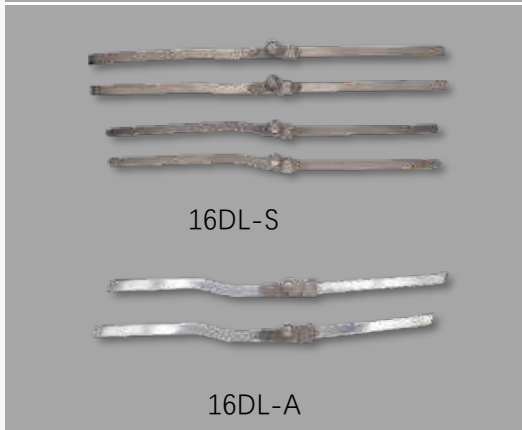

16DL Drop Lock Hinge

Article No.	Specification	width	Weight	Material
16DL-19S	840*19*4 mm	19 mm	1250 g	Stainless Steel
16DL-17S	840*16*4 mm	16 mm	1060 g	Stainless Steel
16DL-13S	800*13*4 mm	13 mm	780 g	Stainless Steel
16DL-19A	840*19*6 mm	19 mm	810 g	Aluminum
16DL-17A	840*17*6 mm	17 mm	610 g	Aluminum
16DL-13A	800*13*5 mm	13 mm	420 g	Aluminum



16DL Child Drop Lock Hinge

- Light type products.

Article No.	Specification	width	Weight	Material
16CDL-13S	470*13*3 mm	13 mm	330 g	Stainless Steel



17PK Axis Posterior Hinge

- Specially for the user who has weakened stretching force caused by flaccid paralysis of lower extremity.
- The hinge has NO mechanical locking strut.

Article No.	Specification	width	Weight	Material
17PK-19S	840*19*4	19 mm	1180 g	Stainless Steel
17PK-19A	840*19*6	19 mm	720 g	

Orthotic Components

Lower Limb for Children

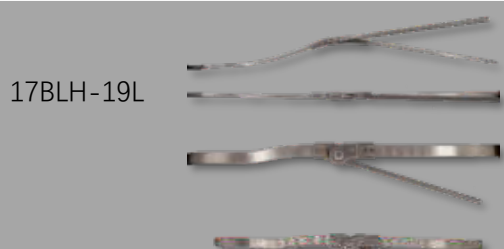

Knee & Hip Joints

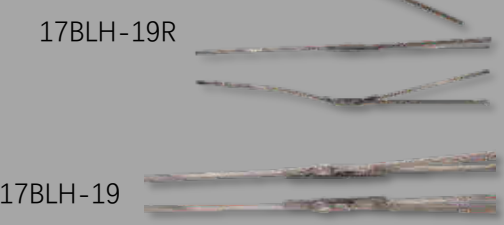

Modular Feet



Modular Components

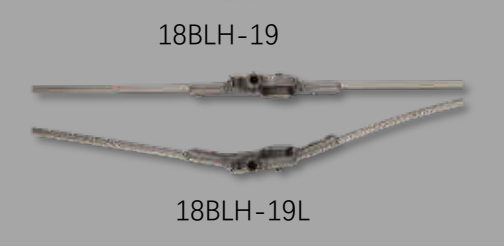

Lock & Liner



Upper Prosti.

Silicon Cosmetic Prosti.

Accessories & Materials



Tools

Ortho. Components

17BLH Bale Lock Hinge

- Approx. weight: 1300g,
- Material: Stainless Steel

Article No.	for side	bar width	Specifications
17BLH-19L	Left	19 mm	Straight & contoured
17BLH-19R	Right	19 mm	Straight & contoured
17BLH-19	Left or Right	19 mm	Straight & Straight

18BLH Bale Lock Hinge

- Approx. weight: 1300g,
- Material: Stainless Steel

Article No.	for side	bar width	Specifications
18BLH-19L	Left	19 mm	Straight & contoured
18BLH-19R	Right	19 mm	Straight & contoured
18BLH-19	Left or Right	19 mm	Straight & Straight

17H100 Bi-axial RGO hip joint system

- Easy-to-use modular system
- Separate components enable the orthosis to fit.
- Torsion-proof aluminum-alloyed pelvic tube allows for moderate connection of joints.

17H300 ARGO hip joint system

- To be used in the case of spinal or traumatic paraplegia (lesion level TH4-L2). Suitable for patients with a weight up to 65 kgs.

Size	Suitable to Length between Hip Trochanters	Specifications
S-Size	25-31 cm	custom-made
M-Size	30-36 cm	
L-Size	35-40 cm	
XL-Size	39-42 cm	
XXL-Size	Over 42 cm	

When ordering, please indicate:

- * Distance between two hip rotors,
- * Distance between hip rotor and knee joint.

FUTURE D&P
ORTHOTICS AND PROSTHETICS

