

## Non-Nuclear Density Meter Quick Start Guide (Version 4.2)

### What's in the Box



Sensor (SRM)



#### 4-20 mA OUTPUT analog cable

- Connects DPM to Plant Control System (PCS) to provide analog output



#### RS485 serial cable with adapter

- Connects DPM to PC
- Can connect DPM to Plant Control System (PCS) to provide a digital output



#### Operators' manual

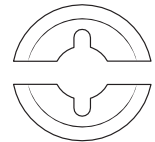

#### Splash guards



#### USB drive with software

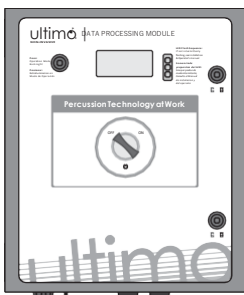

Transmitter (DPM)



#### 4-20 mA INPUT analog cable

- Connects DPM to external sensors (i.e.: flow, pressure, temperature)



#### RS232 serial cable

- Connects DPM to PC
- Use for firmware updates



#### Sensor cable

- Connects SRM to DPM

### Preparing for the System Setup

Before beginning the system set up and initializing the Density Meter's GUI, you must have the following application information available. You will not be able to complete the installation without this information.

Physical Parameters
Pipe material
Liner material, if applicable
Pipe size
Pipe schedule, or Pipe I.D. and O.D.

Instrument Calibration & Output
<b>Measuring Density/% Solids/Concentration:</b> Process variable Measurement Range
<b>Analog Output Interface (4-20 mA Loop):</b> 4 mA Output - Minimum Reading Value 20 mA Output - Maximum Reading value

Process Parameters
Application Type: Density, Percent Solids, Concentration, or Mass Flow
If using Percent Solids measurement: <ul style="list-style-type: none"> <li>• Dry Solids density</li> <li>• Liquid Carrier density</li> </ul>
If using Mass Flow Outputting: <ul style="list-style-type: none"> <li>• Volume flow rate range (min, max)</li> </ul>

## Mounting the SRM to a Straight Pipe

1. Position the SRM at or near the center of the Measurement Zone (**Note:** Refer to **Site Preparation Guides** documents in the **Downloads** tab on Ultimo website for more information).
2. Attach the SRM with worm-gear hose clamps to metal pipes. Attach with constant tension worm gear clamp to plastic pipes.
3. Attach the Splash Guards to the SRM using the provided fasteners.  
Note: The SRM may be mounted on a vertical, horizontal, or angled pipe.

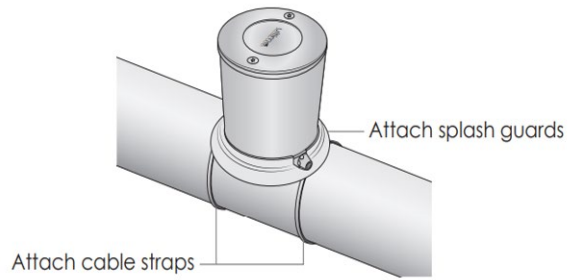

Worm-Gear Clamp for Metal Pipes



Constant Tension Worm-Gear Clamp for Plastic Pipes



## Mounting the SRM to a Pipe with an Elbow

When mounting the SRM on a pipe with a bend or an elbow, the SRM must be positioned perpendicular to the plane that the pipe lies in.

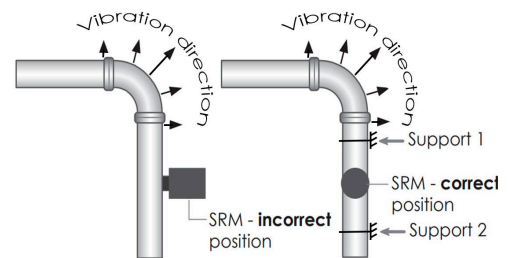

## DPM Display Panel Features

- A. Back Light Button: Lights display/used in Firmware upload.
- B. Display: Displays measurement readings and status messages.
- C. Diagnostic LEDs: Indicates system status.
- D. Power Switch: Power DPM ON and OFF.

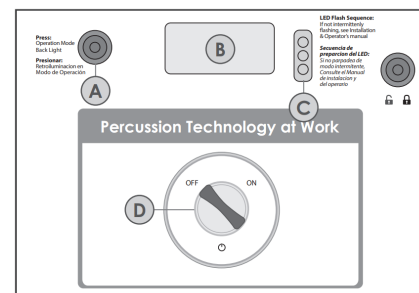

## DPM Connector Panel Features

- A. AC Power Cord
- B. Sensor cable to SRM
- C. USB Port
- D. RS232 connector to computer
- E. RS485 connector to Plant Control System (PCS) or computer
- F. 4-20mA IN, for external sensors
- G. 4-20A OUT to PCS
- H. Data Storage Switch
  - Data Logger: Position for collecting data
  - Computer: Position for setup and calibration
- I. Push to Activate Button for updating configuration file

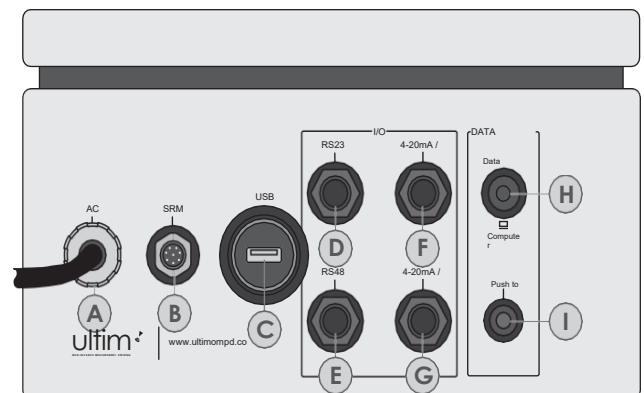

## Powering the DPM

If the attached standard US power cord will not be used, it can be changed to the appropriate cord that meets all local codes and requirements.

1. Open the DPM cabinet door.
2. Remove the US power cord.
3. Insert the new power cord through the hermetic seal on the side panel.
4. Connect the wires to the appropriate terminal blocks.
5. Close and lock the DPM cabinet door.

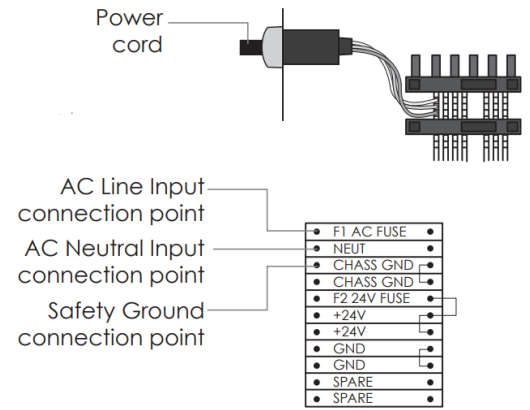

## Connecting the DPM to the Installation PC

1. Switch the DPM to PC Comm Mode:
  - a. Move the DATA STORAGE switch to the COMPUTER position.

The data logger is now off.

Connect the DPM to the Installation PC:

- b. Insert the round connector on the RS485 serial cable into the RS485 connector on the DPM.
- c. Insert the USB connector on the RS485 cable into the PC.

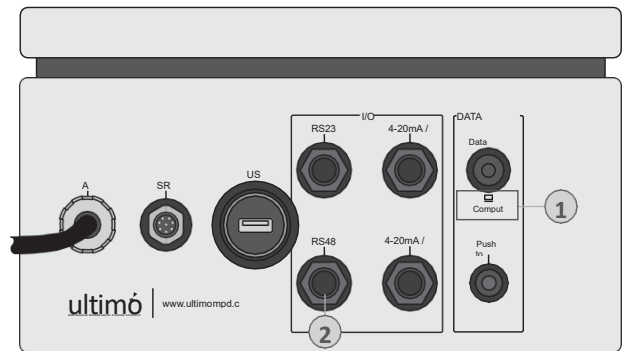

## Enabling DPM to Installation PC Communication

The SRM must be securely mounted to the pipe before applying power or serious damage to the SRM can occur.

**Important!** Do not connect the DPM to the SRM at this time.

1. Turn the DPM power switch to the ON position.
  2. Verify that readable lines of text show up on the display.
- Note:** This may take up to 30 seconds.
3. Verify the LED lights are blinking.

**Note:** If these results do not occur see Section 6.1 in the Operators Manual and verify that all the installation steps have been done correctly.

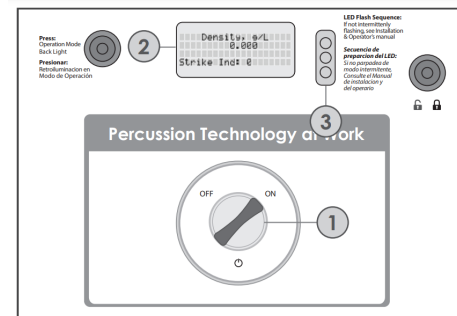

## Connecting the SRM to the DPM

1. Connect the **Sensor cable** to the SRM.
2. Plug the female connector on the **Sensor cable** into the DPM connector that is labeled "SRM".

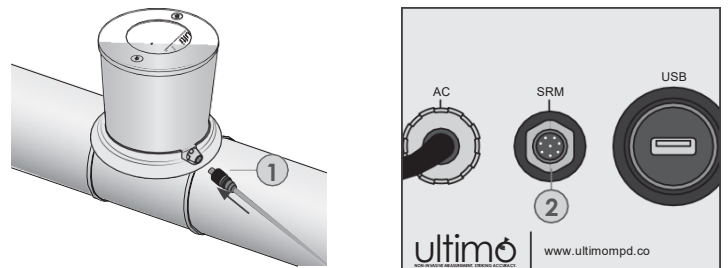

## Preparing the Installation PC Installing the Density Meter's GUI

### Note: System Requirements

- Windows XP or later
- 4 GB RAM
- RS232 and RS485 Drivers

1. Create a new folder on PC named "Installation Site".
2. Insert the ULTIMO USB flash drive in PC.
3. Copy the Ultimo flash drive content into the new folder.

**Note:** If the same PC is used for multiple installations, create separate folders for each density meter.

4. Select and run file named:  
**DVM Setup.msi**

**Important!** Only run this program once on the PC.

5. Ensure the PC is connected to the DPM with the supplied RS485 cable.
6. Make sure the DPM is turned ON.
7. Select and run the file **DM\_Monitor\*.exe**
8. Follow the GUI prompts, verifying each condition when prompted.
9. Select the **Operation** radio button and click **Continue** to enter the guided Device Setup Wizard.
10. The main window of the GUI will pop up.
11. Click on the Setup icon to open the GUI Setup Wizard and begin the setup of the instrument.

11

