

SPECIFICATION SHEET

**BOLLARD - Model MT**





- Up to 5000 lumens
- Dark sky compliant configurations
- LED Accent available on sides of head and pole (optional)
- Patent-pending pole structure design
- Available in 36" to 48" height
- High-definition digital printing
- Low-maintenance DuroClear™ protective coating (no staining, no fading, easy to clean)
- Prewired pole – 24 VDC low-voltage with Easy-access integral drivers
- Concealed cast aluminum base plate



ORDERING OPTIONS

| Model     | Head Accents  | LED module <sup>1</sup> | Head Texture /Color   | Distribution  | Color Temperature   | Height                                      | Pole Texture / Color  | Pole Accents  | Driver          |
|-----------|---|-------------------------|---|---|---|---|---|---|-----------------|
| <b>MT</b> |   |                         |   |   |   |   |   |   | <b>DIM</b>      |
| Model MT  | <b>40K - 4000K</b><br><br><b>60K - 6000K</b><br><br>R - Red<br><br>G - Green<br><br>B - Blue<br><br>Y - Yellow<br><br>GB - Glacier Blue<br><br>NA - No Accent | 5000lm, 36W             | XXXX - See texture chart<br><br>CU - Custom design <sup>2</sup> | FII - Flush lens Type II<br><br>FIII - Flush lens Type III<br><br>FV - Flush lens Type V<br><br>DII - Dome lens Type II<br><br>DIII - Dome lens Type III<br><br>DV - Dome lens Type V | 27K - 2700K<br><br>30K - 3000K<br><br>36K - 3600K<br><br>40K - 4000K<br><br>50K - 5000K<br><br>57K - 5700K<br><br>65K - 6500K | 36 - 36in<br><br>42 - 42in<br><br>48 - 48in | XXXX - See texture chart<br><br>CU - Custom design <sup>2</sup> | 40K - 4000K<br><br>60K - 6000K<br><br>R - Red<br><br>G - Green<br><br>B - Blue<br><br>Y - Yellow<br><br>GB - Glacier Blue<br><br>NA - No Accent | Dimmable driver |

<sup>1</sup> Nominal lumen value.  
<sup>2</sup> Consult factory.  
 Dark sky compliant options.

NOTES

## CONSTRUCTION

Aluminum tapered pole and head assembly made of extruded aluminum, digitally printed aluminum composite panels and cast aluminum. The construction is chemically bonded together to create a robust assembly and a seamless look. The pole is fully prewired in factory and features a proprietary KwikLock™ tenon and quick connector for ease of installation and serviceability.

## LIGHT MODULES

High efficiency, Sealed IP67 LED modules incorporating heat sink for efficient heat dissipation and an impact-resistant lens. The lens is available in two shapes: dome to maximize output or flush for reduced uplight and glare control.

## LED ACCENTS

Our unique design integrates LED Accents as an option, covered by a printed acrylic diffuser that matches the selected fixture finish. The accents are located on the four corners of the pole and the position on the head varies according to the model. The accents color can be specified from a variety of options.

## ELECTRICAL

CETL US listed for wet location and certified to CSA STDs C22.2 250.0, 206 and conforms to UL STDs 1598. Surge protected 100-277V 50/60hz Class II integral dimmable driver located at the base and accessible through hand hole. Dimmable driver compatible with ELV, MLV, 0-10V, 1-10V, PWM and wired to a potentiometer in factory. Operating temperature is -40°C to 70°C / -40°F to 158°F.

## FINISH

Pretreated primer coated aluminum, then digitally printed with the selected texture or design. Consult the factory for custom textures application or to integrate any logos, indications or other references to your finish. The printed surface is covered with our proprietary DUROCLEAR clear coat, tested in accordance with ASTM standards for the following:



ASTM G155  
UV resistance



ASTM D3389  
Abrasion Test



ASTM B117  
Salt Spray Resistance



ASTM D6578  
Graffiti Resistance



ASTM D3359-B  
Adhesion Test

## WARRANTY



15 years limited warranty against defects in workmanship on pole and fixture heads and excessive fading of the finish. LEDs are covered for 10 years and Drivers are covered for 7 years. Please refer to the warranty section of our website for additional information : [zilux warranty](#)



6330 Zéphirin-Paquet Street - Local 1B  
G2C 0M3 Québec QC - Canada  
[info@zilux.com](mailto:info@zilux.com) - 418 842-3222

## DIMENSIONS

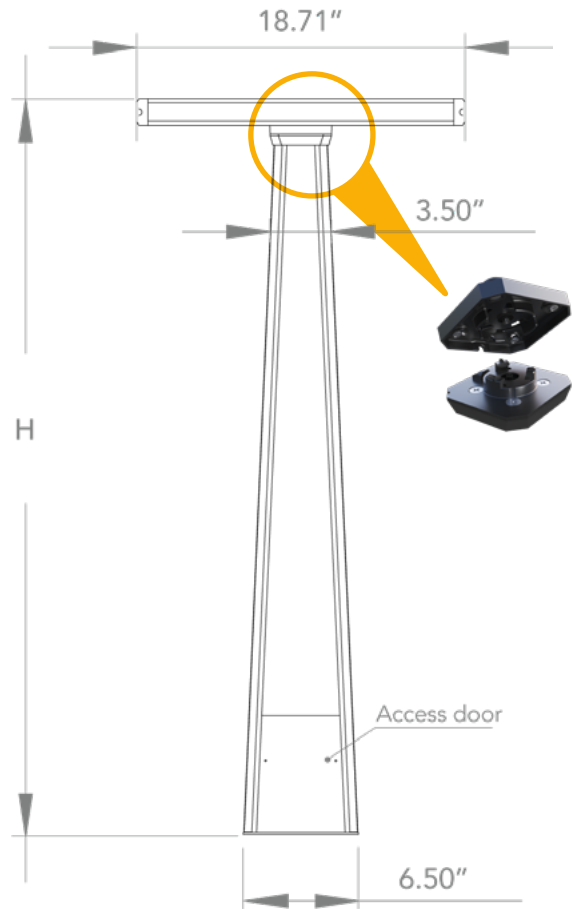

## BASE PLATE

Internal base plate made of heavy duty cast aluminum. Base plate is anchored directly on mounting surface using factory supplied mounting hardware.

### BASE PLATE

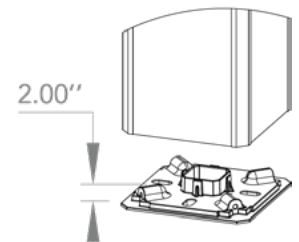
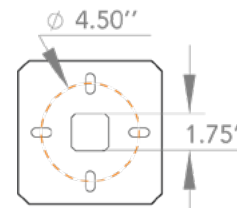

\*Recommended anchor bolt projection

## SERVICEABILITY

Drivers are accessible through the hand hole at the base of the post. Access door is flush mounted, digitally printed to match the pole finish and secured with anti-theft screws. All electrical components are field serviceable.

WOOD



WD-1



WD-2



WD-3



WD-4



WD-5



WD-6



WD-7



WD-8



WD-9



WD-10



WD-11



WD-12



WD-13



WD-14



WD-15

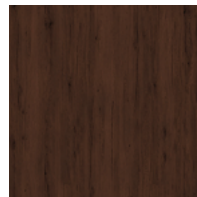

WD-16



WD-17

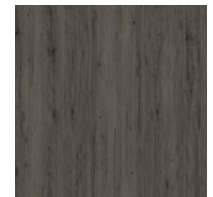

WD-18



WD-19



WD-20



WD-21

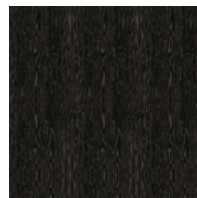

WD-22

MARBLE

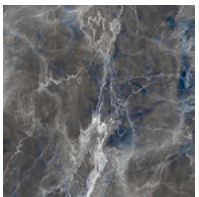

MB-1

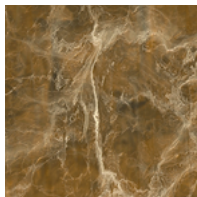

MB-2

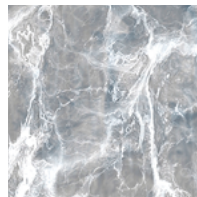

MB-3

RUST METAL

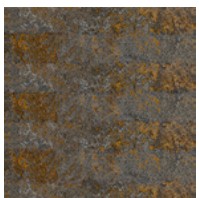

RM-1



RM-2

DIAMOND



DM-1



DM-3

CONCRETE

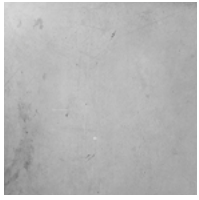

CC-1



CC-2

VEGETAL

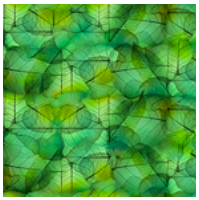

VG-1

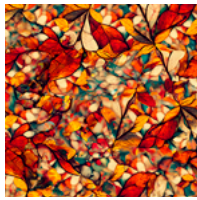

VG-2

STONE

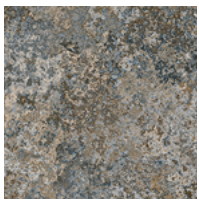

ST-1

MISCELLANEOUS

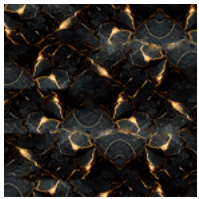

MISC-1



\*Consult us to design your new texture



Online textures