

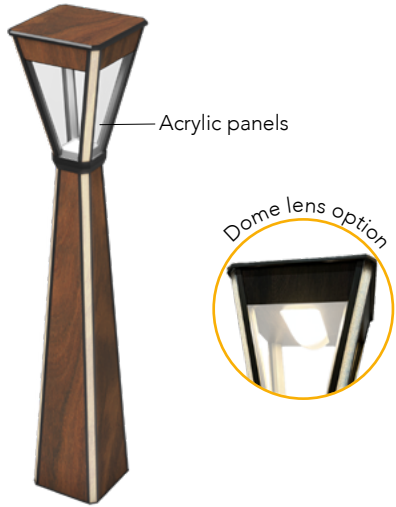

SPECIFICATION SHEET

BOLLARD - Model MV





- Up to 2500 lumens
- LED Accent available on sides of head and pole (optional)
- Patent-pending pole structure design
- Available in 36" to 48" height
- High-definition digital printing
- Low-maintenance DuroClear™ protective coating (no staining, no fading, easy to clean)
- Prewired pole – 24 VDC low-voltage with Easy-access integral drivers
- Concealed cast aluminum base plate
- Sealed head enclosure using impact resistant clear acrylic panels on all our sides



ORDERING OPTIONS

Model	Head Accents	LED module ¹	Head Texture / Color	Distribution	Color Temperature	Height	Pole Texture / Color	Pole Accents	Driver
MV									DIM
MV - Model MV	40K - 4000K	2500lm, 18W	XXXX - See texture chart	FII - Flush lens Type II	27K - 2700K	36 - 36in	XXXX - See texture chart	40K - 4000K	dimmable driver
	60K - 6000K		CU - Custom design ²	FIII - Flush lens Type III	30K - 3000K	42 - 42in	CU - Custom design ²	60K - 6000K	
	R - Red			FV - Flush lens Type V	36K - 3600K	48 - 48in		R - Red	
	G - Green			DII - Dome lens Type II	40K - 4000K			G - Green	
	B - Blue			DIII - Dome lens Type III	50K - 5000K			B - Blue	
	Y - Yellow			DV - Dome lens Type V	57K - 5700K			Y - Yellow	
	GB - Glacier Blue				65K - 6500K			GB - Glacier Blue	
	NA - No Accent							NA - No Accent	

¹ Nominal lumen value.
² Consult factory.

NOTES

CONSTRUCTION

Aluminum tapered pole and head assembly made of extruded aluminum, digitally printed aluminum composite panels and cast aluminum. The head structure is closed with a clear acrylic cover. The construction is chemically bonded together to create a robust assembly and a seamless look. The pole is fully prewired in factory and features a proprietary KwikLock™ tenon and quick connector for ease of installation and serviceability.

LIGHT MODULES

High efficiency, Sealed IP67 LED modules incorporating heat sink for efficient heat dissipation and an impact-resistant lens. The lens is available in two shapes: dome to maximize output or flush for reduced uplight and glare control.

LED ACCENTS

Our unique design integrates LED Accents as an option, covered by a printed acrylic diffuser that matches the selected fixture finish. The accents are located on the four corners of the pole and the position on the head varies according to the model. The accents color can be specified from a variety of options.

ELECTRICAL

CETL US listed for wet location and certified to CSA STDs C22.2 250.0, 206 and conforms to UL STDs 1598. Surge protected 100-277V 50/60hz Class II integral dimmable driver located at the base and accessible through hand hole. Dimmable driver compatible with ELV, MLV, 0-10V, 1-10V, PWM and wired to a potentiometer in factory. Operating temperature is -40°C to 70°C / -40°F to 158°F.

FINISH

Pretreated primer coated aluminum, then digitally printed with the selected texture or design. Consult the factory for custom textures application or to integrate any logos, indications or other references to your finish. The printed surface is covered with our proprietary DUROCLEAR clear coat, tested in accordance with ASTM standards for the following:



ASTM G155
UV resistance



ASTM D3389
Abrasion Test



ASTM B117
Salt Spray Resistance



ASTM D6578
Graffiti Resistance



ASTM D3359-B
Adhesion Test

WARRANTY



15 years limited warranty against defects in workmanship on pole and fixture heads and excessive fading of the finish. LEDs are covered for 10 years and Drivers are covered for 7 years. Please refer to the warranty section of our website for additional information : [zilux warranty](#)



6330 Zéphirin-Paquet Street - Local 1B
G2C 0M3 Québec QC - Canada
info@zilux.com - 418 842-3222

DIMENSIONS

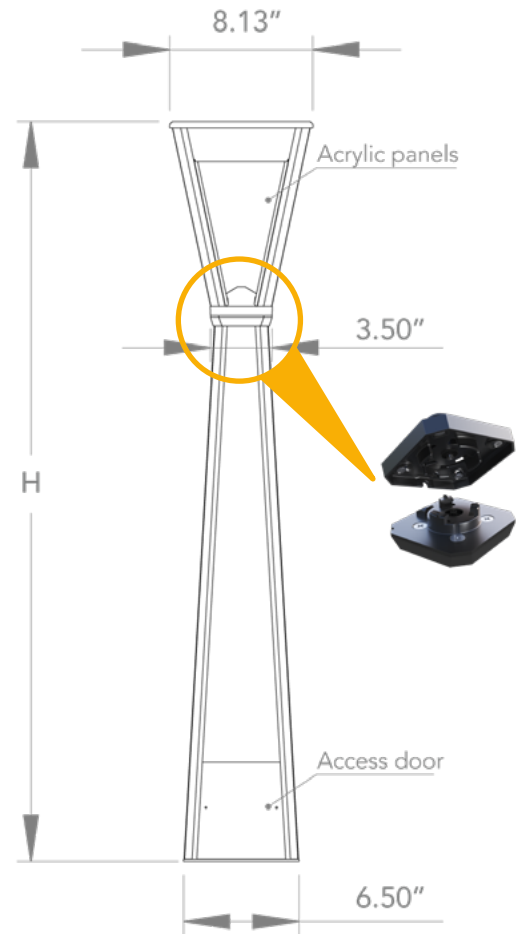

BASE PLATE

Internal base plate made of heavy duty cast aluminum. Base plate is anchored directly on mounting surface using factory supplied mounting hardware.

BASE PLATE

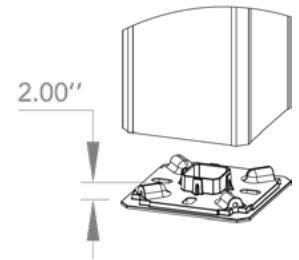
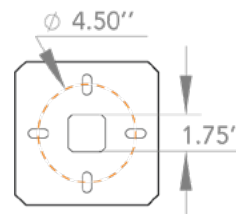

*Recommended anchor bolt projection

SERVICEABILITY

Drivers are accessible through the hand hole at the base of the post. Access door is flush mounted, digitally printed to match the pole finish and secured with anti-theft screws. All electrical components are field serviceable.

WOOD



WD-1



WD-2



WD-3



WD-4



WD-5



WD-6



WD-7



WD-8



WD-9



WD-10



WD-11



WD-12



WD-13



WD-14



WD-15

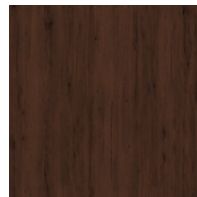

WD-16

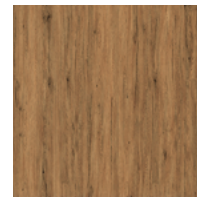

WD-17

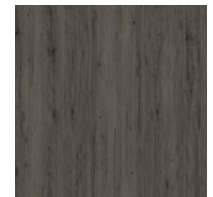

WD-18



WD-19



WD-20



WD-21

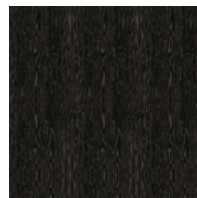

WD-22

MARBLE

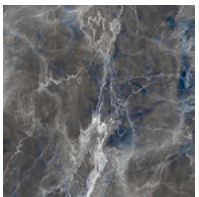

MB-1

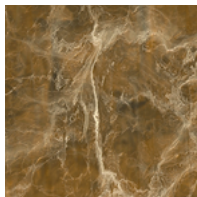

MB-2

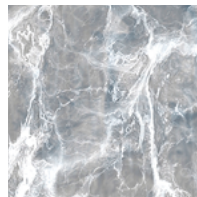

MB-3

RUST METAL

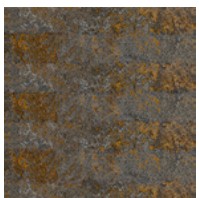

RM-1



RM-2

DIAMOND



DM-1



DM-3

CONCRETE

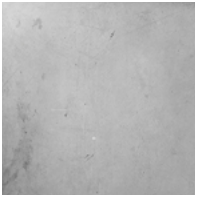

CC-1



CC-2

VEGETAL

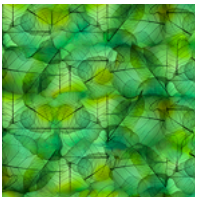

VG-1



VG-2

STONE



ST-1

MISCELLANEOUS

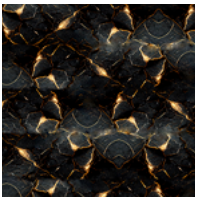

MISC-1



*Consult us to design your new texture



Online textures