

Lantech

User Manual (Hardware)

T(P)GS-H7624XT

24 1G Copper + 6 10G Copper (w/ PoE at/af) EN50155 OS5 Managed Ethernet Switch

T(P)GS-H7624XFT

24 1G Copper + 4 10G Copper + 2 10Q Q-ODC Fiber (w/ PoE at/af)
EN50155 OS5 Managed Ethernet Switch

T(P)GS-H7616XT

16 1G Copper + 6 10G Copper (w/ PoE at/af) EN50155 OS5 Managed Ethernet
Switch

T(P)GS-H7608XT

8 1G Copper + 6 10G Copper (w/ PoE at/af) EN50155 OS5 Managed Ethernet Switch

V1.06

MAY. 2026

RP-001-31

Approval Information

Version 1.06	Name	Title	Date
Author	Alice Huang	Marketing	2026.05.14
Verifier	Jacky Chou	HW QA	2026.05.14
Approver	Thomas Lee	RD head	2026.05.14

Version	Date	Content of Modification	Author(s)
V1.00	2025.03.13		Greg Tsai
V1.01	2025.03.17	Update the 110V attention scenarios	Greg Tsai
V1.02	2025.06.20	Enhance warnings associated with bypass usage.	Greg Tsai
V1.03	2025.10.28	Added unit conversion to torque guideline: 14 kgf·cm \approx 1.4 N·m.	Alice Huang
V1.04	2026.02.05	Add bypass port distance 50M	Greg Tsai
V1.05	2026.02.25	Update the bypass diagram and distance 25M	Greg Tsai
V1.06	2026.05.14	Update the PEXT T-code installation section	Greg Tsai

Recommendation for Shielded network cables

STP cables have additional shielding material that is used to reduce external interference. The shield also reduces emissions at any point in the path of the cable. Our recommendation is to deploy an STP network cable in demanding electrical environments. Examples of demanding indoor environments are where the network cable is located in parallel with electrical mains supply cables or where large inductive loads such as motors or contactors are in close vicinity to the camera or its cable. It is also mandatory to use an STP cable where a power device (like an IP camera) is used outdoors or where the network cable is routed outdoors.



Important Notice

Lantech Communications Global, Inc. reserves the right to modify the equipment, its specification or this manual without prior notice, in the interest of improving performance, reliability, or servicing. At the time of publication all data is correct for the operation of the equipment at the voltage and/or temperature referred to. Performance *data* indicates typical values related to the particular product.

No part of this documentation or information supplied may be divulged to any third party without the express written consent of Lantech Communications Global Inc. Products offered may contain software which is proprietary to Lantech Communications Global Inc. The offer or supply of these products and services does not include or infer any transfer of ownership.

Interference Issues

This Equipment has been tested and has been found to comply with the limits for a Class A digital device, pursuant to Part 15 of the FCC rules. These limits are designed to provide reasonable protection against harmful interference in a commercial or industrial installation. This equipment generates, uses, and can radiate radio frequency energy. It may cause harmful interference to radio communications if the equipment is not installed and used in accordance with the instructions.

FCC Warning

This Equipment has been tested and found to comply with the limits for a Class-A digital device, pursuant to Part 15 of the FCC rules. These limits are designed to provide reasonable protection against harmful interference in a residential installation. This equipment generates, uses, and can radiate radio frequency energy. It may cause harmful interference to radio communications if the equipment is not installed and used in accordance with the instructions. However, there is no guarantee that interference will not occur in a particular installation. If this equipment does cause harmful interference to radio or television reception, which can be determined by turning the equipment off and on, the user is encouraged to try to correct the interference by one or more of the following measures:

- Reorient or relocate the receiving antenna.
- Increase the separation between the equipment and receiver.
- Connect the equipment into an outlet on a circuit different from that to which the receiver is connected.
- Consult the dealer or an experienced radio/TV technician for help.

CE Mark Warning

This is a Class-A product. In a domestic environment this product may cause radio interference in which case the user may be required to take adequate measures.

Content

Chapter 1	Hardware Description	6
1.1	Physical Dimension	6
1.2	Package Content:.....	11
1.3	IP Protection.....	12
1.4	Front Panel.....	15
1.5	Bypass design	20
Chapter 2	Hardware Installation	22
2.1	Wall mount installation	22
Chapter 3	Connect Cable	25
3.1	Power input M12 connector.	25
3.2	Power input for optional external PoE supply (-PEXT model).....	28
3.3	Console & USB dongle M12 connector	29
3.4	DI/DO M12 connector	30
3.5	1G/10G interface M12 connector	32
3.6	Q-ODC fiber interface	33
3.6	Ground interface M6 connector	33
Chapter 4	Maintenance	35
Chapter 5	Console Management	36
5.1	Connecting to the Console Port	36
5.2	Login in to the Console Interface	36
Chapter 6	Reset the Switch.....	37

Chapter 1 Hardware Description

Lantech T(P)GS-H7XXX series are high performance OS5 EN50155 10G uplink Ethernet switches with up to 24 10/100/1000T (incl. up to 24 PoE at/af injectors) by M12 connectors which provides L2 wire speed and advanced security function for connecting PD network.

In this paragraph, it will describe the Industrial switch's hardware spec, port, cabling information, and wiring installation.

1.1 Physical Dimension

T(P)GS-H7624XT

Aluminum case. IP-54, 390mm(W)x103mm(H)x225mm(D)

-OOB-PEXT model

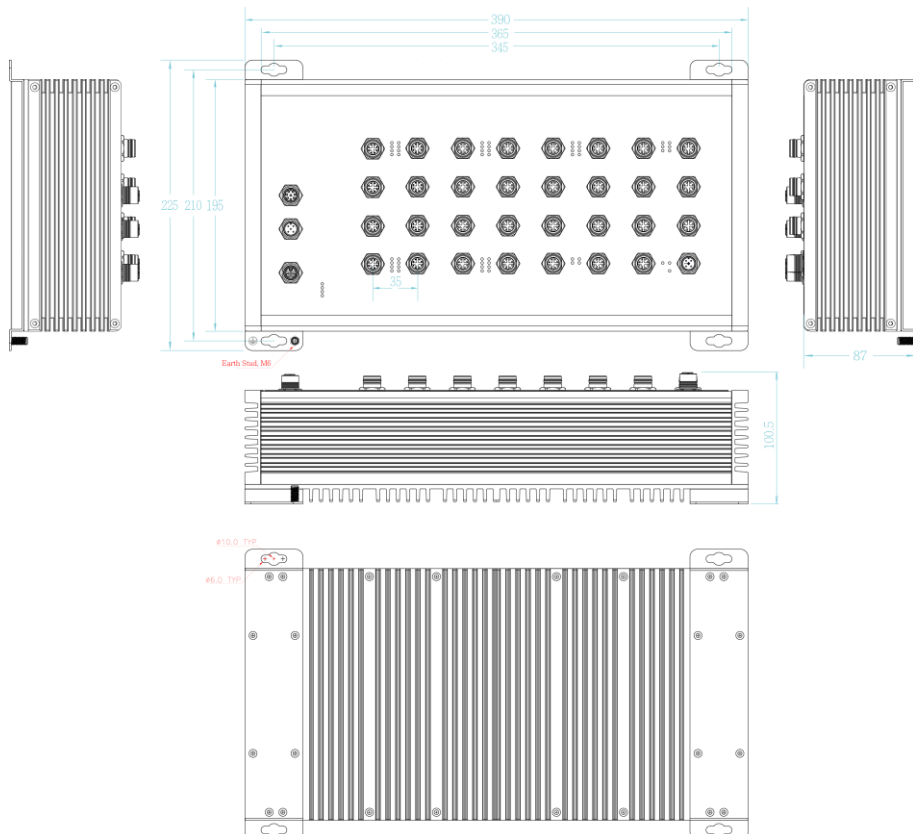

w/o -OOB-PEXT model

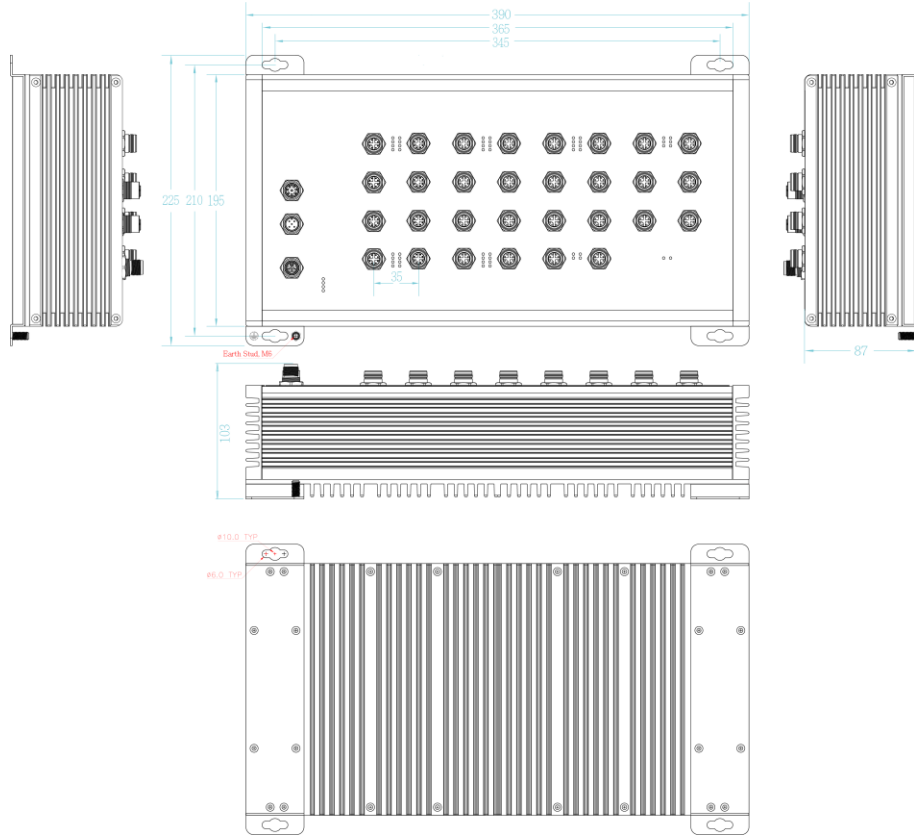

T(P)GS-H7624XFT

Aluminum case. IP-54, 390mm(W)x108.2mm(H)x225mm(D)

-OOB-PEXT model

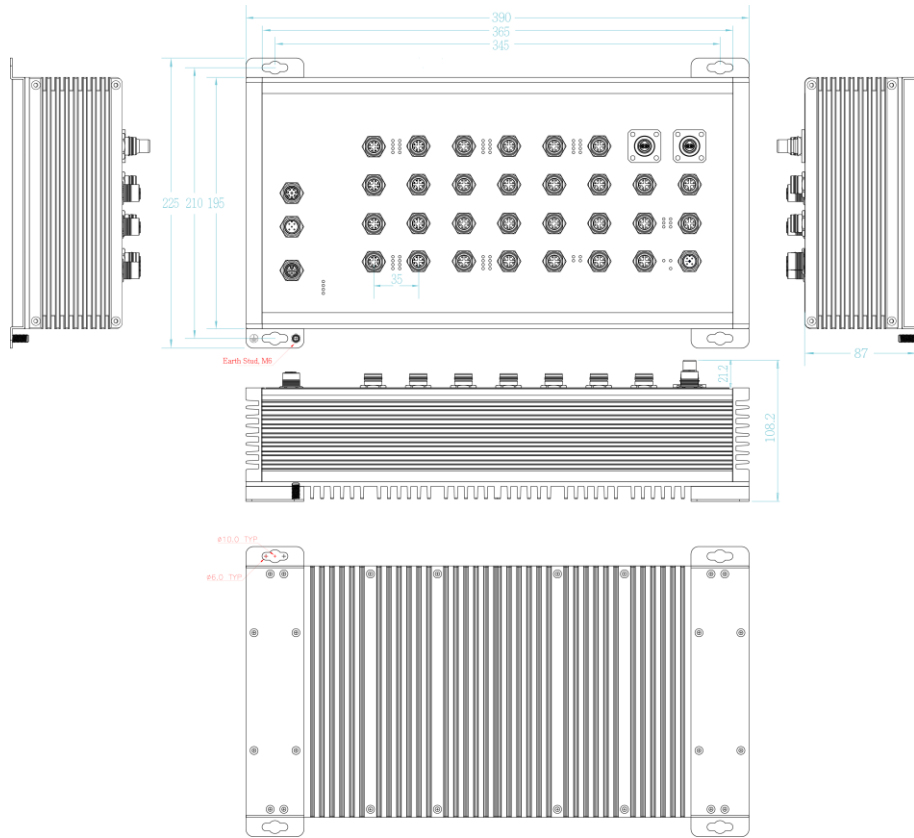

w/o -OOB-PEXT model

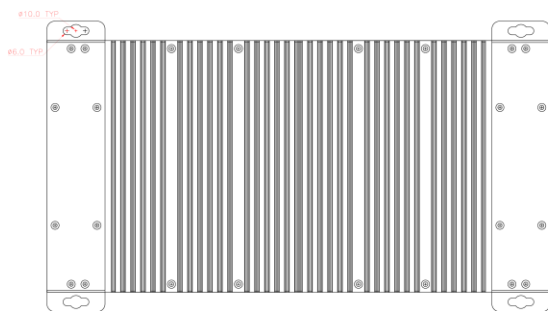
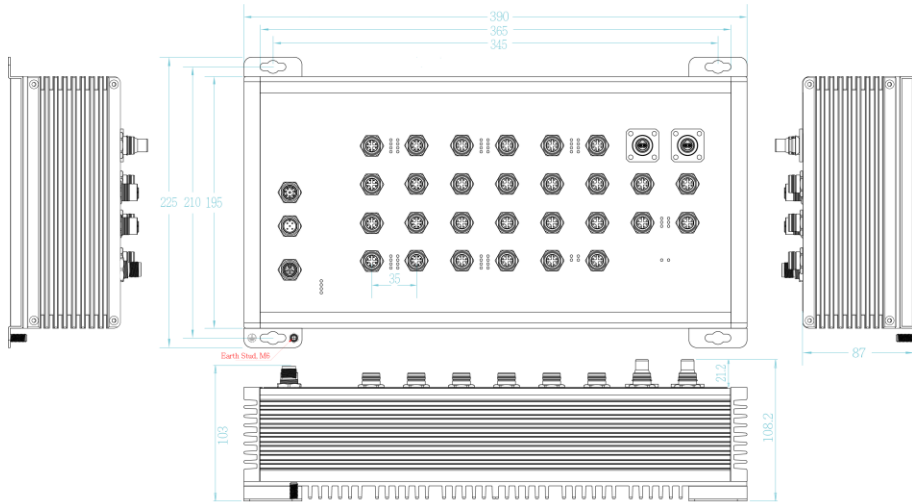

T(P)GS-H7616XT

Aluminum case. IP-54, 390mm(W)x103mm(H)x225mm(D)

-OOB-PEXT model

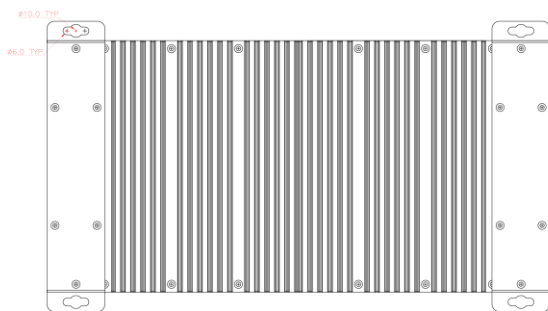
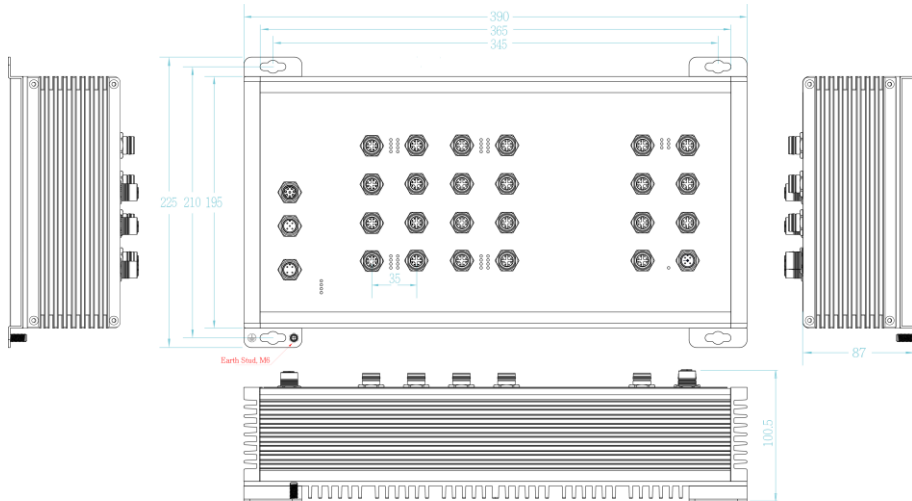

w/o -OOB-PEXT model

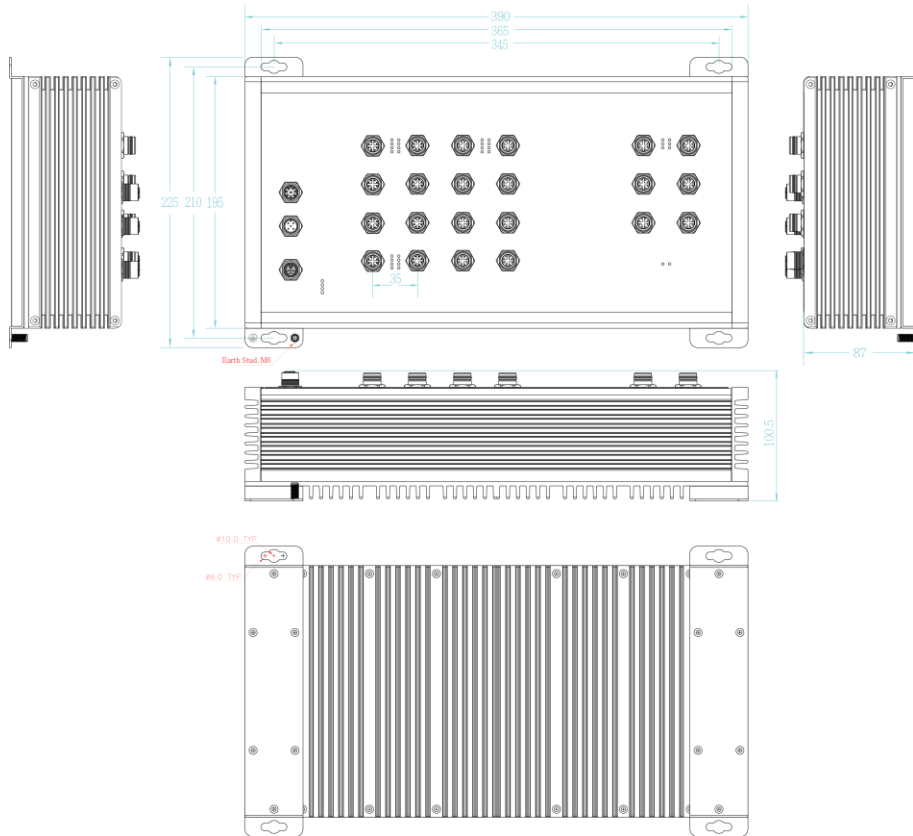

T(P)GS-H7608XT

Aluminum case. IP-54, 390mm(W)x103mm(H)x225mm(D)

-OOB-PEXT model

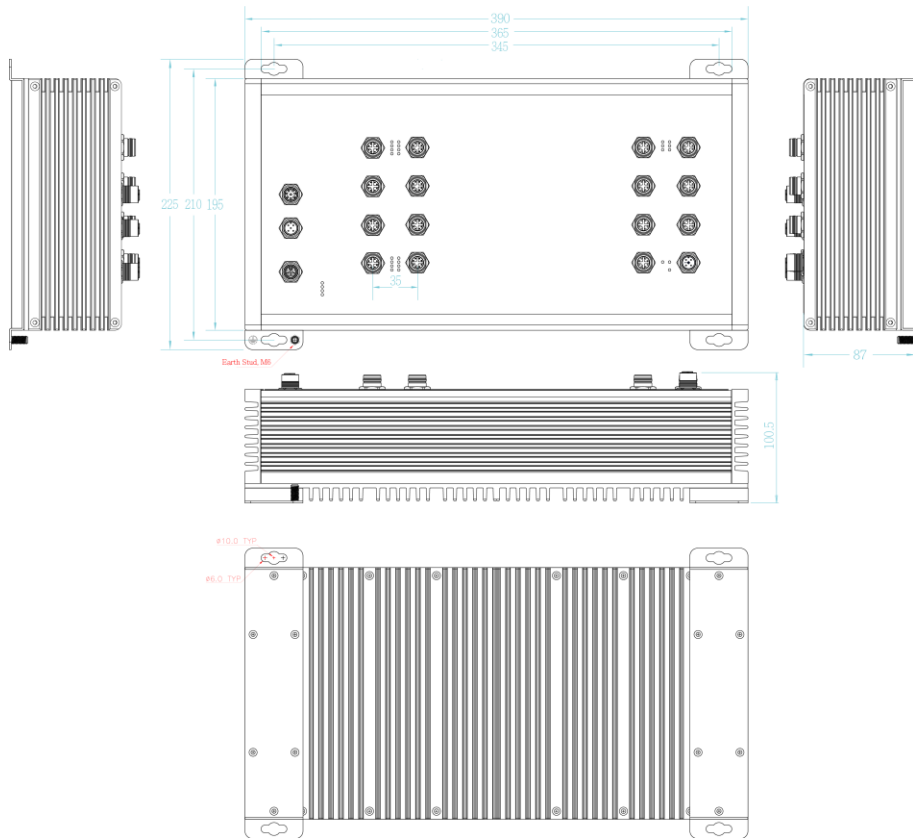

w/o -OOB-PEXT model

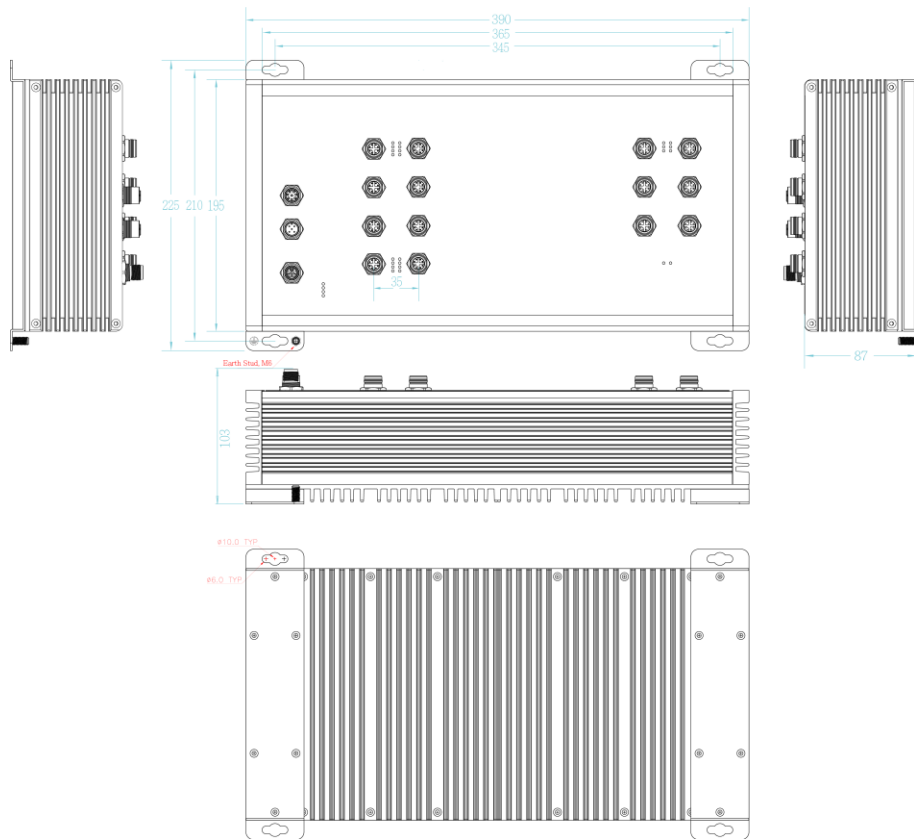

1.2 Package Content:

- Product
- Console cable

1.3 IP Protection

The **IP Code, Ingress Protection Rating**, sometimes also interpreted as **International Protection Rating**, classifies and rates the degree of protection provided against the intrusion (including body parts such as hands and fingers), dust, accidental contact, and water in *mechanical casings* and with electrical enclosures. It is published by the International Electrotechnical Commission (IEC)

Solid particle protection

The first digit indicates the level of protection that the enclosure provides against access to hazardous parts (e.g., electrical conductors, moving parts) and the ingress of solid foreign objects.

Level	Object size protected against	Effective against
0	—	No protection against contact and ingress of objects
1	>50 mm	Any large surface of the body, such as the back of a hand, but no protection against deliberate contact with a body part
2	>12.5 mm	Fingers or similar objects
3	>2.5 mm	Tools, thick wires, etc.
4	>1 mm	Most wires, screws, etc.
5	Dust protected	Ingress of dust is not entirely prevented, but it must not enter in sufficient quantity to interfere with the satisfactory operation of the equipment; complete protection against contact
6	Dust tight	No ingress of dust; complete protection against contact

Liquid ingress protection

The second digit indicates the level of protection that the enclosure provides against harmful ingress of water.

Level	Protected against	Testing for	Details
0	Not protected	—	—
1	Dripping water	Dripping water (vertically falling drops) shall have no harmful effect.	Test duration: 10 minutes Water equivalent to 1 mm rainfall per minute
2	Dripping water when tilted up to 15°	Vertically dripping water shall have no harmful effect when the enclosure is tilted at an angle up to 15° from its normal position.	Test duration: 10 minutes Water equivalent to 3 mm rainfall per minute
3	Spraying water	Water falling as a spray at any angle up to 60° from the vertical shall have no harmful effect.	Test duration: 5 minutes Water volume: 0.7 litres per minute Pressure: 80–100 kPa
4	Splashing of water	Water splashing against the enclosure from any direction shall have no harmful effect.	Test duration: 5 minutes Water volume: 10 litres per minute Pressure: 80–100 kPa
5	Water jets	Water projected by a nozzle (6.3 mm) against enclosure from any direction shall have no harmful effects.	Test duration: at least 15 minutes Water volume: 12.5 litres per minute Pressure: 30 kPa at distance of 3 m

6	Powerful water jets	Water projected in powerful jets (12.5 mm nozzle) against the enclosure from any direction shall have no harmful effects.	Test duration: at least 3 minutes Water volume: 100 litres per minute Pressure: 100 kPa at distance of 3 m
7	Immersion up to 1 m	Ingress of water in harmful quantity shall not be possible when the enclosure is immersed in water under defined conditions of pressure and time (up to 1 m of submersion).	Test duration: 30 minutes Immersion at depth of at least 1 m measured at bottom of device, and at least 15 cm measured at top of device
8	Immersion beyond 1 m	The equipment is suitable for continuous immersion in water under conditions which shall be specified by the manufacturer. Normally, this will mean that the equipment is hermetically sealed. However, with certain types of equipment, it can mean that water can enter but only in such a manner that it produces no harmful effects.	Test duration: continuous immersion in water Depth specified by manufacturer
9	Powerful high temperature water jets	Protected against close-range high pressure, high temperature spray downs.	—

1.4 Front Panel

✘ The PoE and bypass icon may vary depending on different models.

TPGS-H7624XT (-OOB-PEXT model)

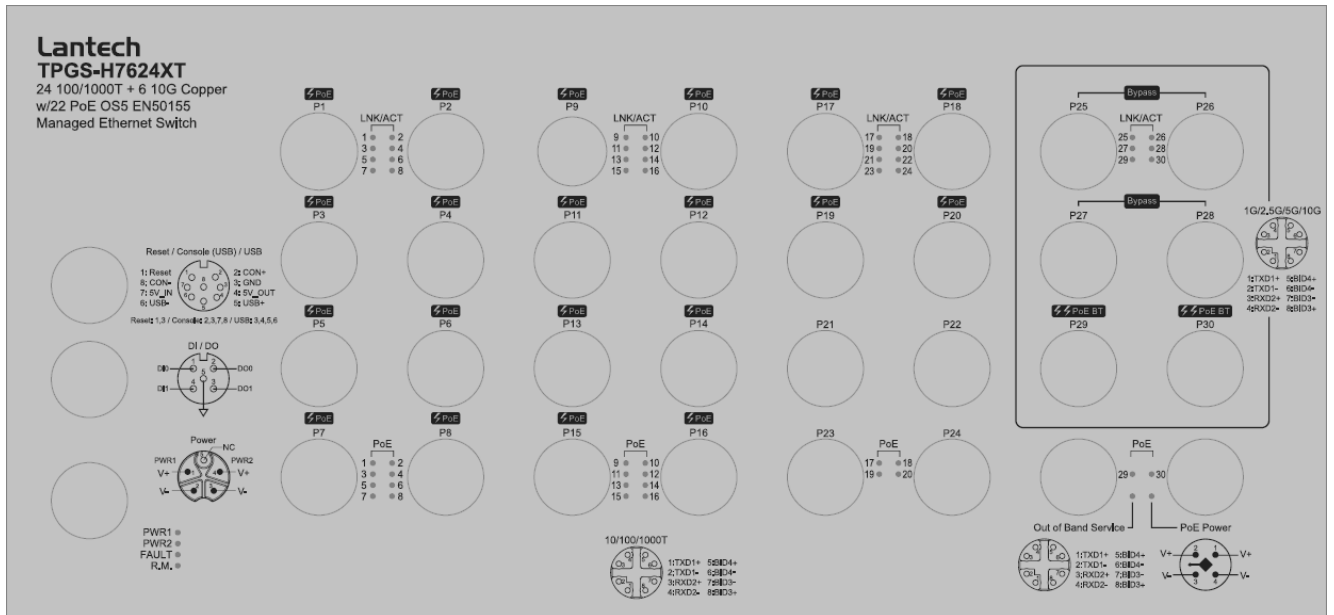

TPGS-H7624XT (w/o -OOB-PEXT model)

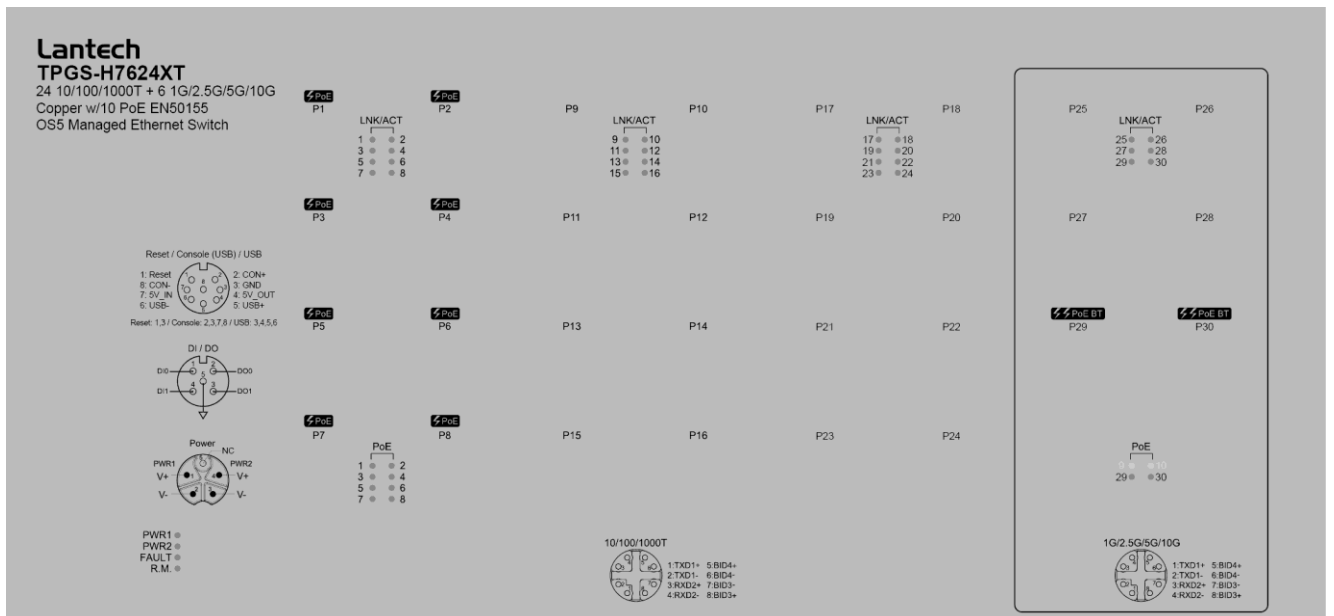

TPGS-H7624XFT (-OOB-PEXT model)

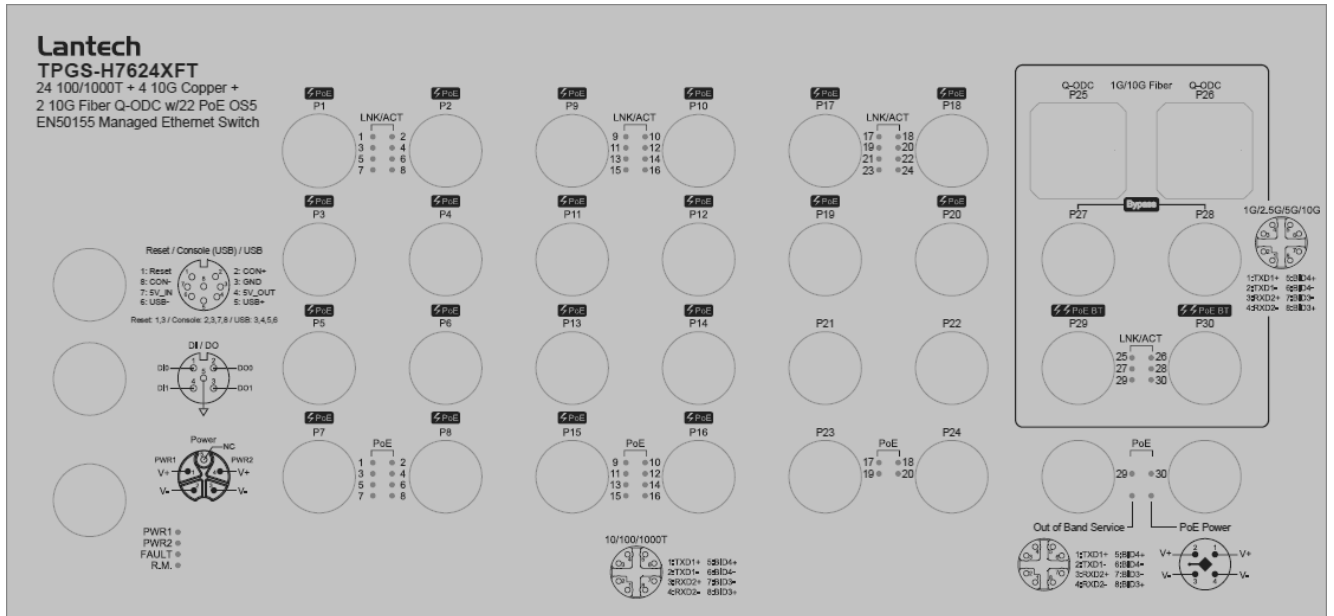

TPGS-H7624XFT (w/o -OOB-PEXT model)

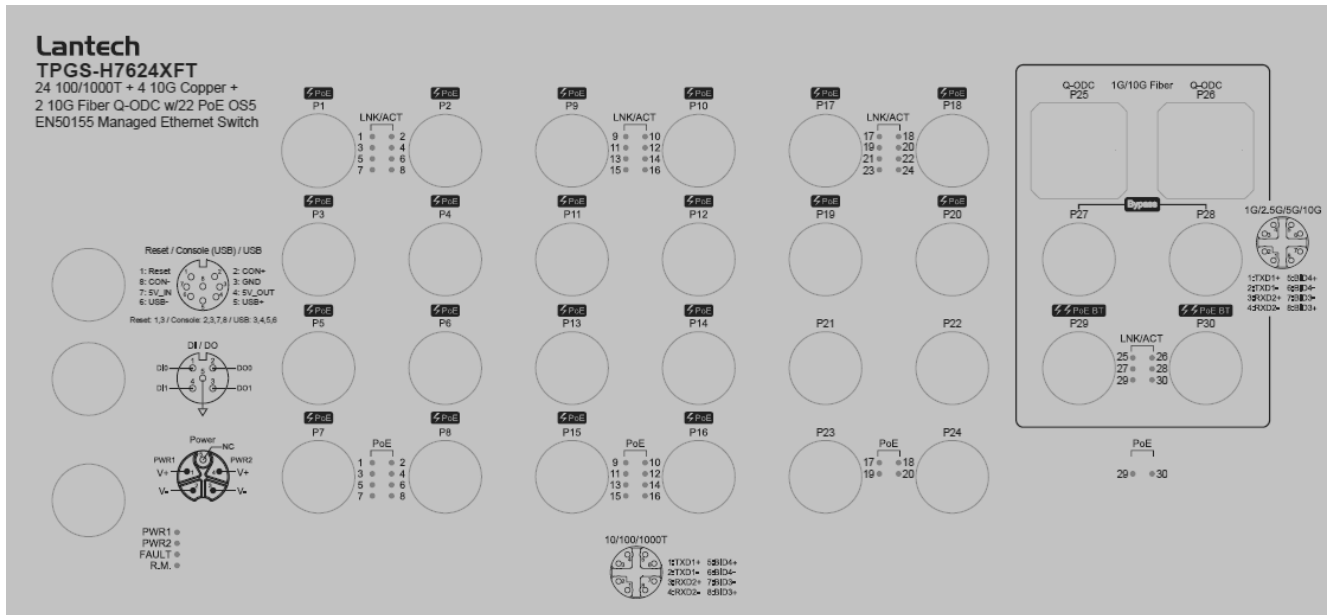

TPGS-H7616XT (-OOB-PEXT model)

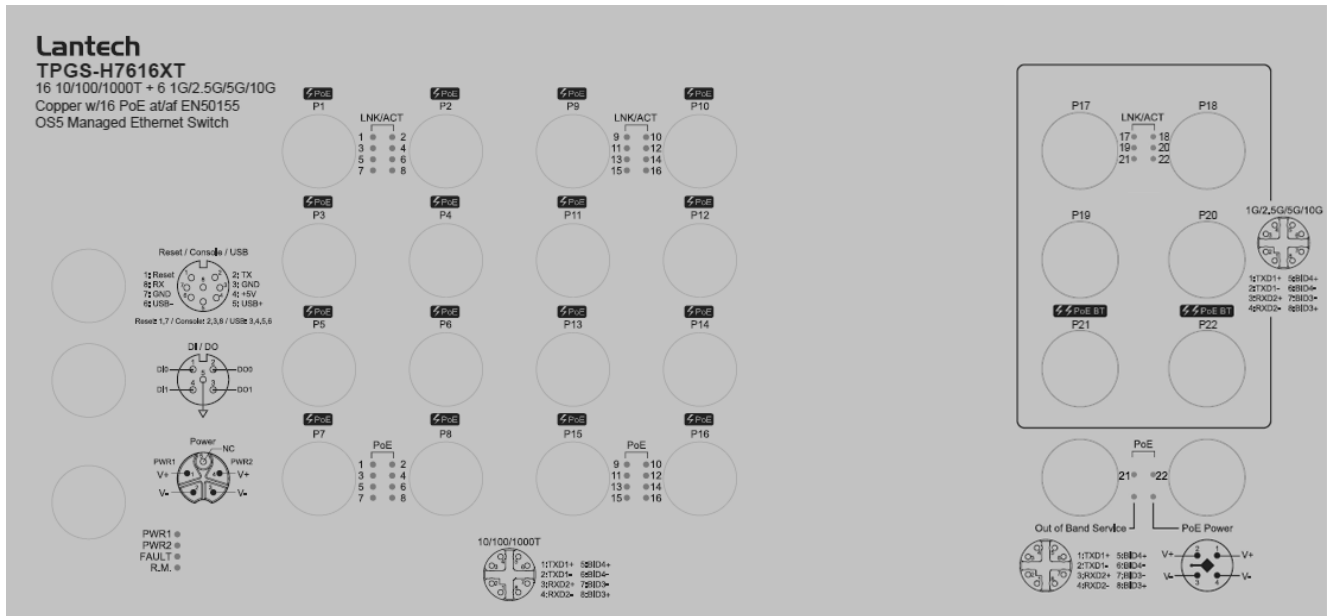

TPGS-H7616XT (w/o -OOB-PEXT model)

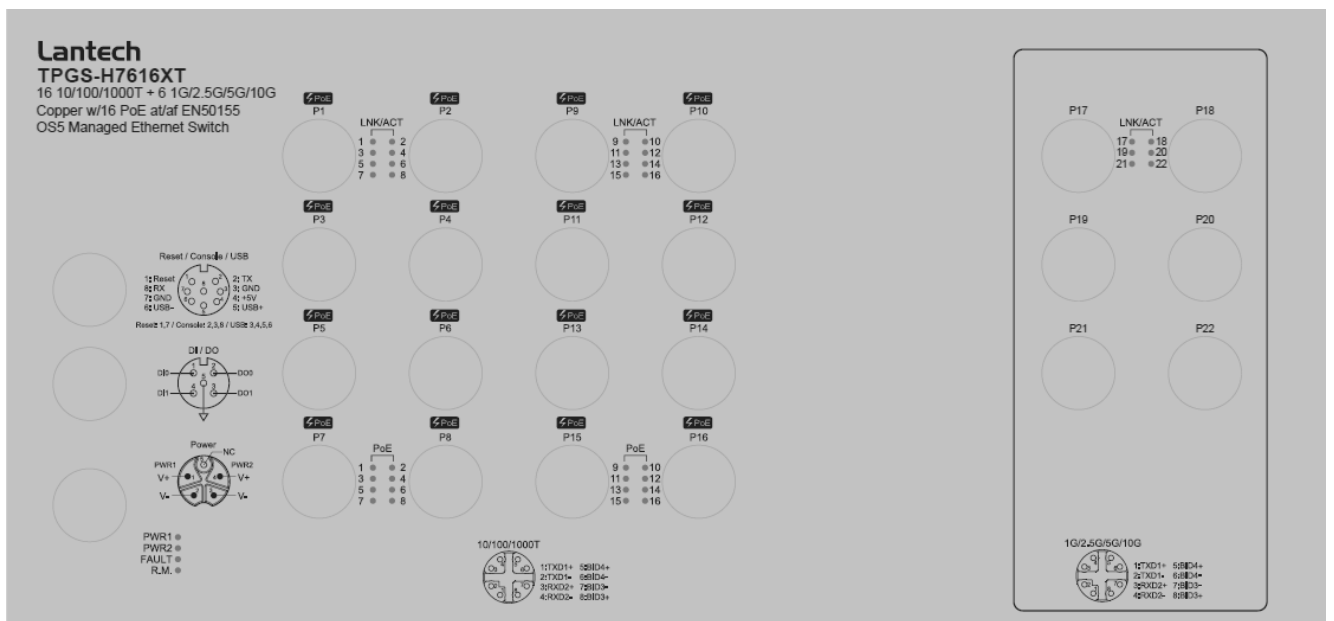

TPGS-H7608XT (-OOB-PEXT model)

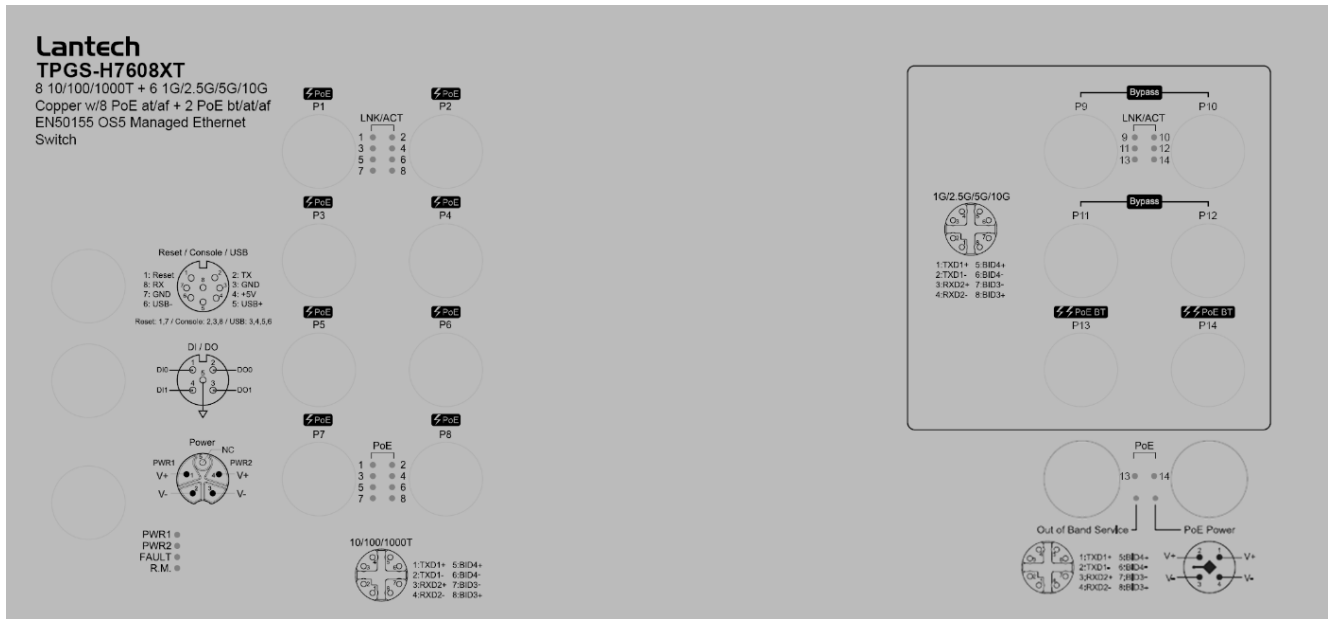

TPGS-H7608XT (w/o -OOB-PEXT model)

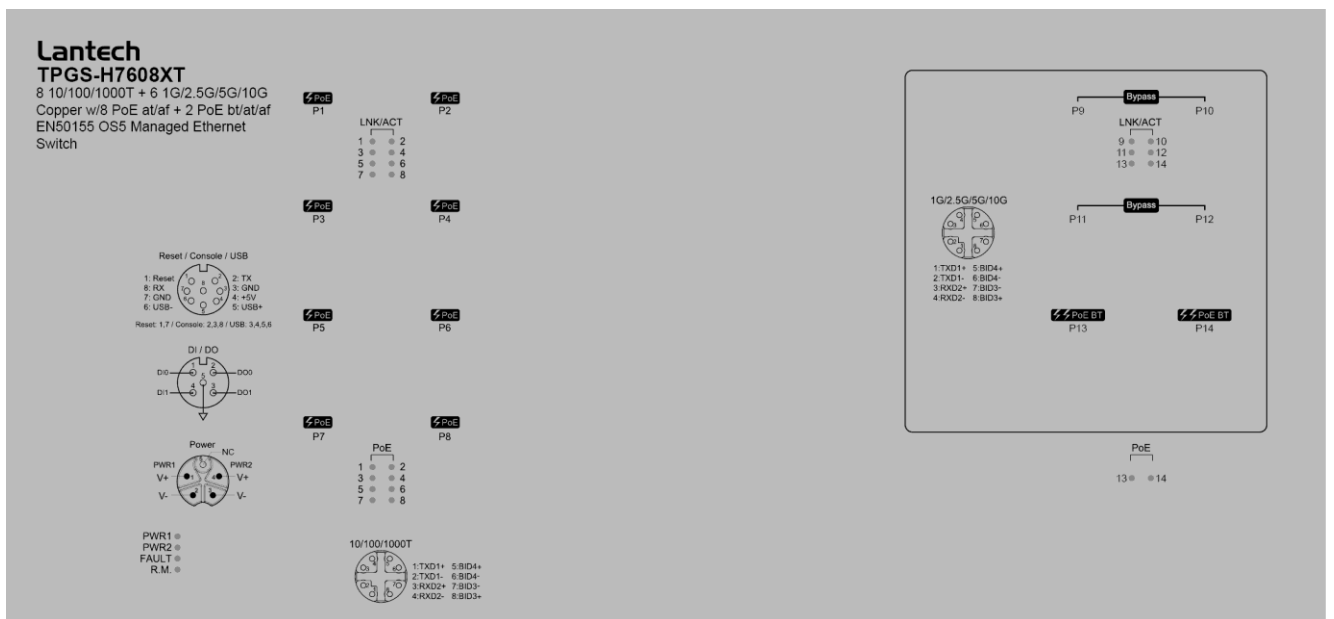

LED Indicators

The diagnostic LEDs that provide real-time information of system and optional status are located on the front panel of the industrial switch. The following table provides the description of the LED status and their meanings for the switch.

LED	Color	Status	Meaning
R.M	Green	On	The switch unit is owner switch of ITU-Ring
		Off	The switch is not owner switch
PWR1	Green	On	Power 1 is active
		Off	Power 1 is inactive
PWR2	Green	On	Power 2 is active
		Off	Power 2 is inactive
FAULT	Red	On	Power or port failure
		Off	No failure
10/100/1000 T Copper Link/Act	Green	On	A network device is detected.
		Blinking	The port is transmitting or receiving packets from the TX device.
		Off	No device attached
1G/2.5G/5G/10G Copper Link/Act	Yellow / Orange	On(Yellow)	A network device with 1G/2.5G/5G interface is detected.
		On(Orange)	A network device with 10G copper interface is detected.
		Blinking	The port is transmitting or receiving packets from the TX device
		Off	No device attached
1G/10G Q-	Link/Act	On(Orange)	A network device is detected.

ODC Fiber		Off	No device attached
Notification: Q-ODC fiber ports are designed with 10G fiber interface and extend from CPU, not PHY chipset. So both these ports don't support blinking status when data is forwarding via a fiber port or both.			
PoE (PoE models)	On	The port is operating in PoE mode.	
	Off	The port is not operating in PoE mode.	

1.5 Bypass design

(Available on -BT/-BBT/-BF/-BBT-BF models; **Maximum copper uplink by-pass port distance is 25m**)

Warning: The total cable length for copper bypass connections must not exceed 50 meters, including all segments between intermediate devices (e.g., Switch 1 to 2 + 2 to 3). Exceeding this cumulative distance may result in packet loss and network instability.

The bypass module is like an alarm relay but it has default position – close. When system finish booting procedures, CPU will ask bypass module change position from close to open and keep in open status. That's why when switch loss the power, bypass module will be active, because CPU has no ability to ask bypass module keep in open status then bypass will be restored to default position – close.

Bypass mechanism in open status

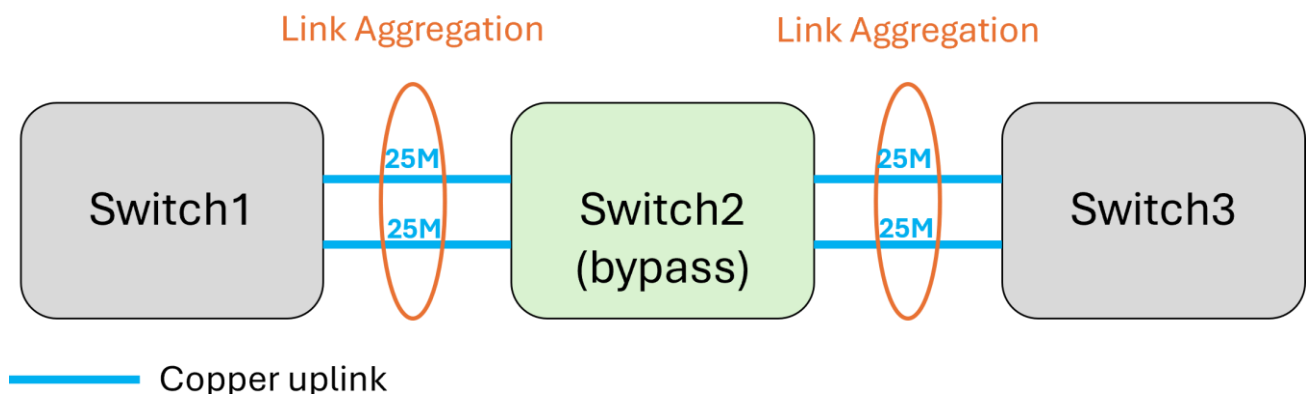

Bypass mechanism in close status

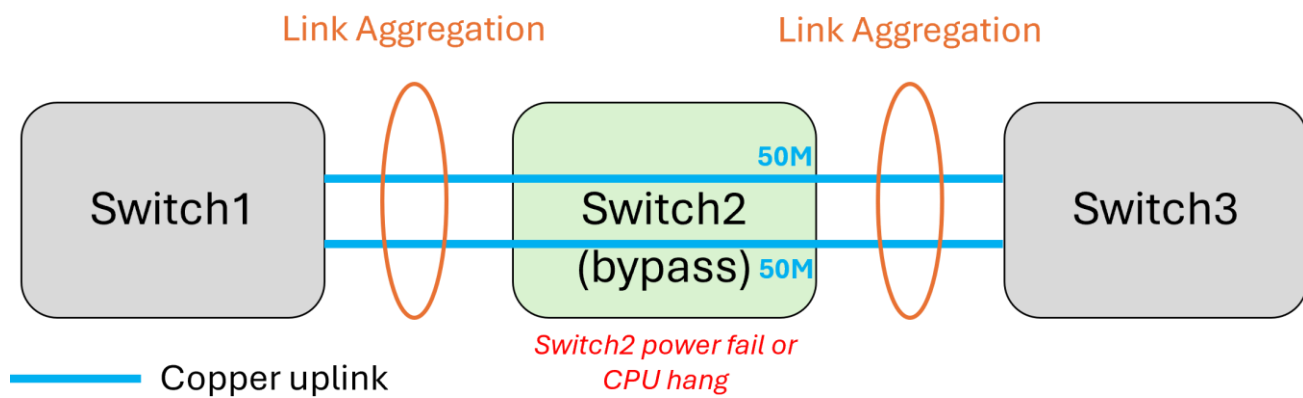

Chapter 2 Hardware Installation

There are no mechanically active moving parts in the switch, to fix the switch into an installation position, please use M4 size screw and corresponding nut and standard M4 screwdriver to install switch in the field.

2.1 Wall mount installation

1. Please make sure the screw diameter is M4.

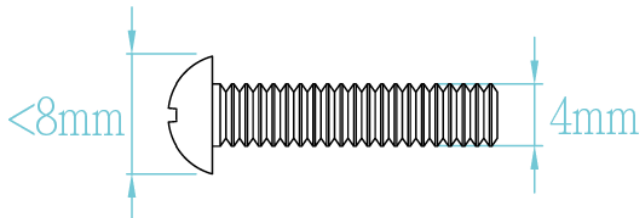

2. Check all 4 fix holes on the switch and find corresponding position in the wall .Use the appropriate tool to drill 4 holes onto the corresponding position, make sure the diameter of holes is compatible with the M4 screws, fix the 4 screws into these 4 holes but don't screw tightly, in order to have enough space to mount the switch.



3. Mount switch in wall with 4 fixed screws.

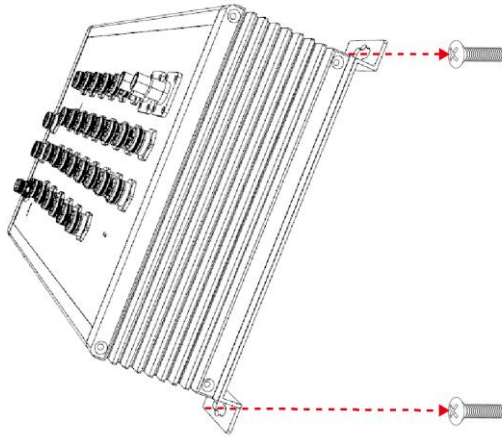

4. Attach switch in wall with 4 screws

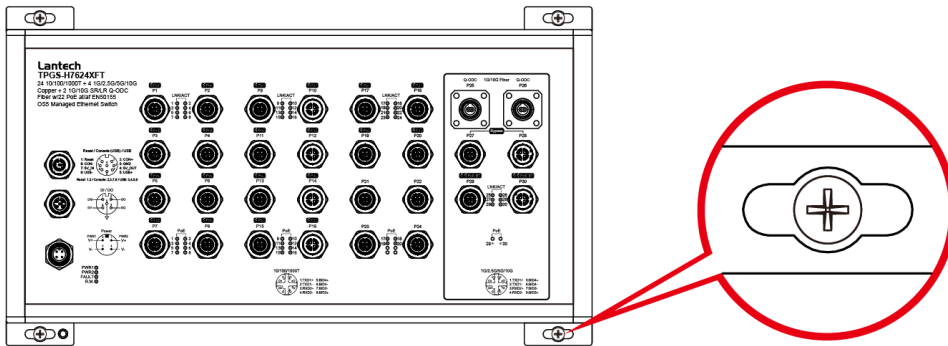

5. Move down

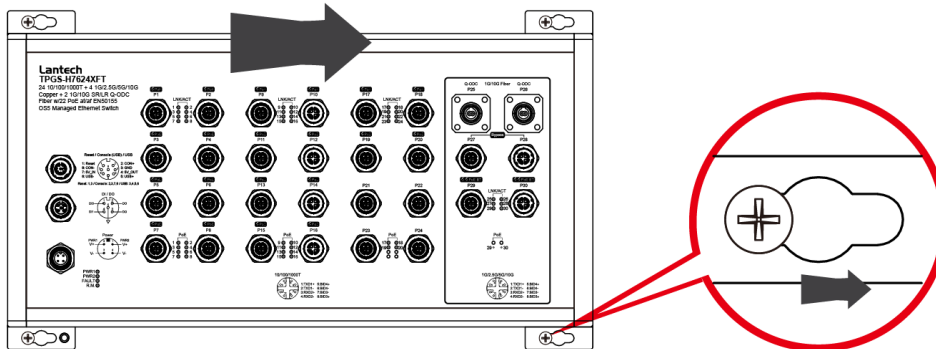

6. Tighten 4 screws

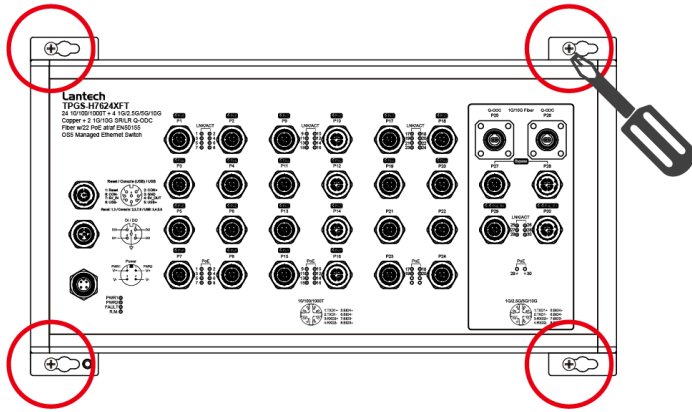

Chapter 3 Connect Cable



Notice

Correctly connecting the grounding cable is crucial to lightning protection and EMI protection. To avoid damages caused by surge or EFT, using STP cable is highly suggested.

Alert! PoE Budget for Managed POE Switch Model

For managed PoE models, the factory-default PoE budget is 12W per port; however, users can customize the PoE budget for each port based on their requirements. Managed switches have a safety feature where, if the total PoE budget is exceeded, the last connected port will automatically be disabled to prevent overloading.

Please be mindful of the total PoE budget limit. To prevent ports from shutting down due to insufficient budget, set the desired PoE budget for each used port and set the PoE budget for idle ports or ports that do not require PoE to "0". Once the preceding ports consume the entire PoE budget, the subsequent ports will not provide power for devices.

After the hardware installation is complete, please connect the cable to the switch. All the external interfaces use M12 connector design and follow IEC 61076 standard except the for the fiber interface with QODC connector. The M12 connector on the 10G copper interface supports IEC 61076-2-109 standard, make sure the connector for the 10G cable also supports this standard or it will reduce the Max throughput of the 10G copper interface.

3.1 Power input M12 connector.

Note: Please check the power connector has been connected to the switch correctly before you turn on the power resource.

Spec. of power input

- Voltage of Power Input:
Dual DC input, 16.8VDC~137.5VDC
- Total PoE budget: Internal 120W
450W with external PoE power supply (-PEXT model)
Please make sure that the external power supply unit can satisfy the total power consumption in field.
- Pin assignment of power input

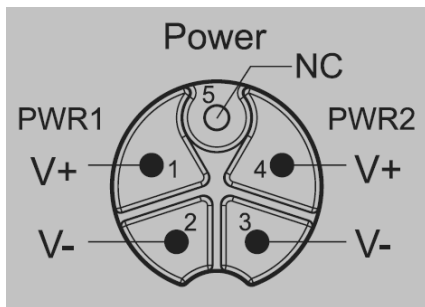

- Pin assignment of optional power cable ECABM12-05K(F)-90-1.5M

PWR1 V+	●—————●	RED
PWR1 V-	●—————●	BLACK
PWR2 V-	●—————●	WHITE
PWR2 V+	●—————●	GREEN
NC	●—————●	X
<u>CON1</u>		<u>OPEN</u>

*The color is based on the optional power cable of Lantech.

- Make sure the direction of connector is correct before you connect it.

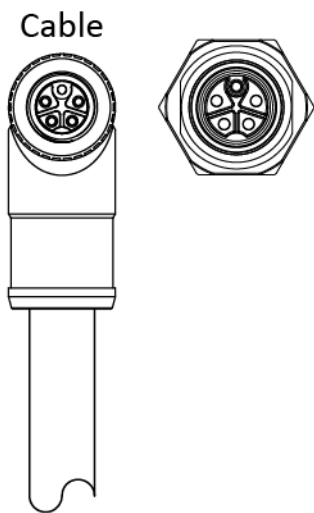

- Plug power connector and screw in clockwise direction to fix it.

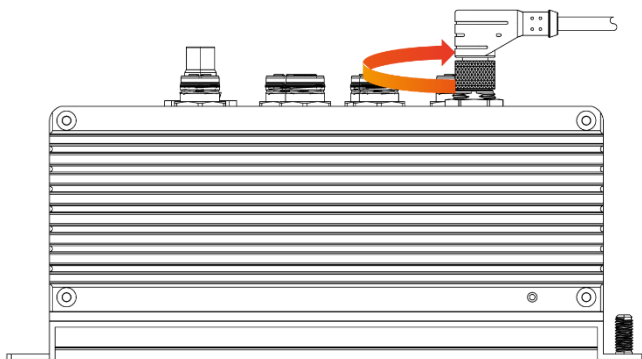
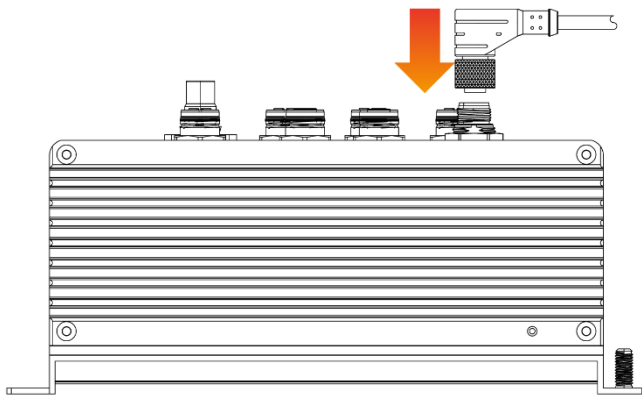

Attention: When connecting to 110V DC power sources, the following scenarios can damage to the switch. Please avoid these scenarios.

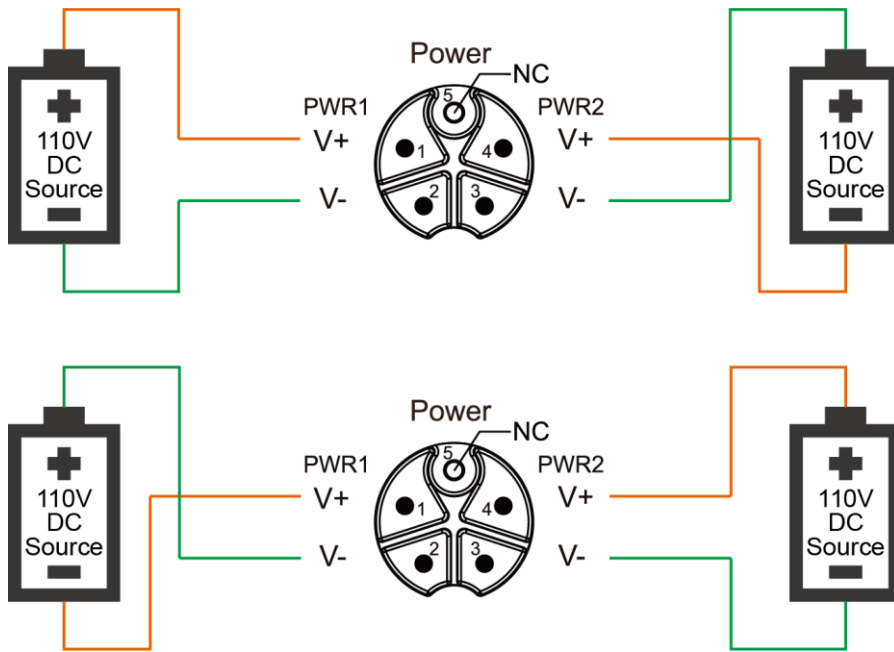

3.2 Power input for optional external PoE supply (-PEXT model)

- Pin assignment

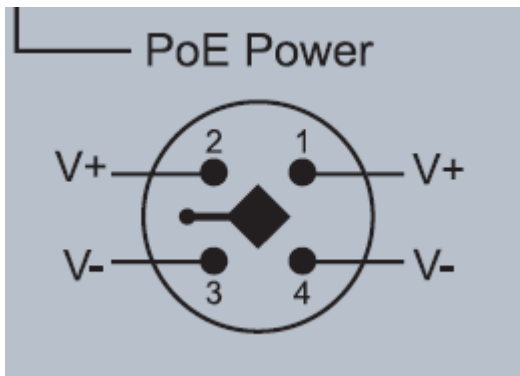

Warning: Using a 90° T-code power cable may obstruct other ports (see reference image below). For optimal compatibility, use a 180° cable instead.



3.3 Console & USB dongle M12 connector

- Pin assignment of console & USB dongle

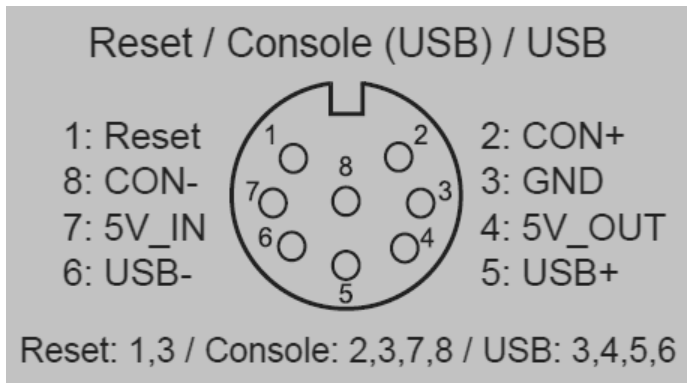

- Make sure the connector is the right direction before you connect it.

Cable

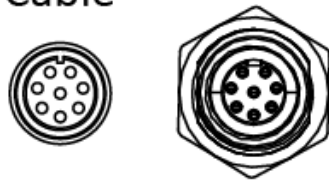

- Plug console connector and screw in clockwise direction to fix it. For push-pull cable, just plug the cable to the connector.

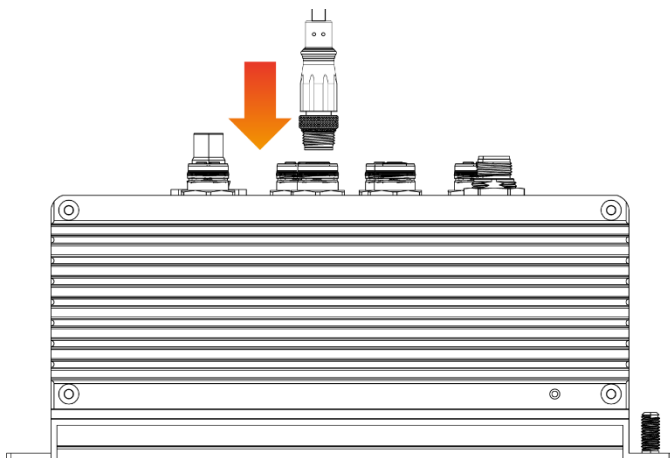

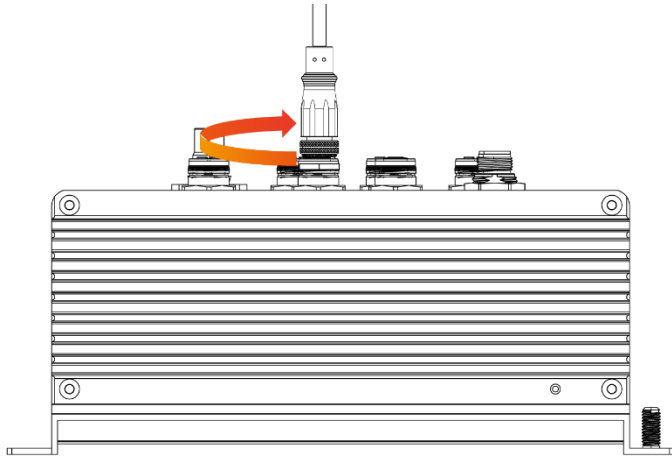

3.4 DI/DO M12 connector

In case of event, the switch being able to send an email to pre-defined addresses as well as SNMP Traps out immediately. It provides 2DI and 2DO (DI=Digital input / DO=Digital output). When disconnection of the specific port was detected; DO will activate the signal LED to alarm. DI can integrate the sensors for events and DO will trigger the alarm while sending alert information to IP network with email and traps.

- Pin assignment of the DI/DO port

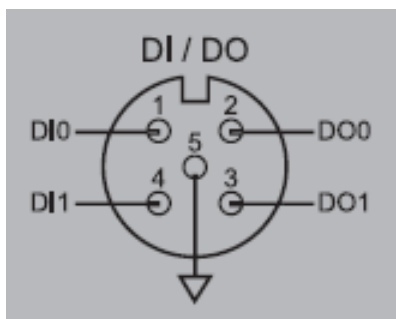

- Make sure the direction of connector is correct before you connect it.

Cable



- Plug DI/DO connector and screw in clockwise direction to fix it. For push-pull cable, just plug the cable to the connector.

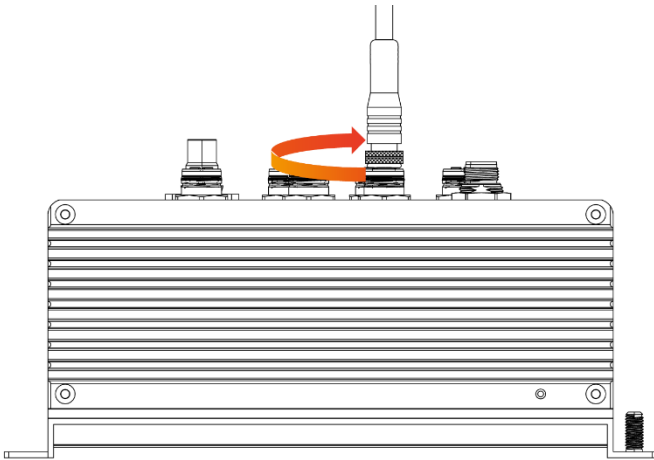
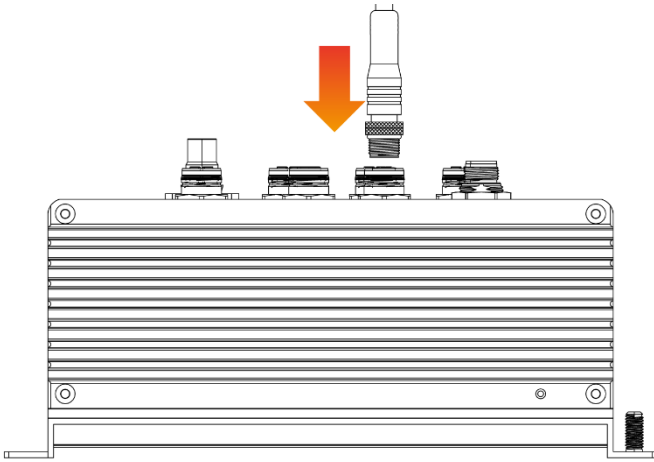

3.5 1G/10G interface M12 connector

- Pin assignment of the 1G/10G copper port

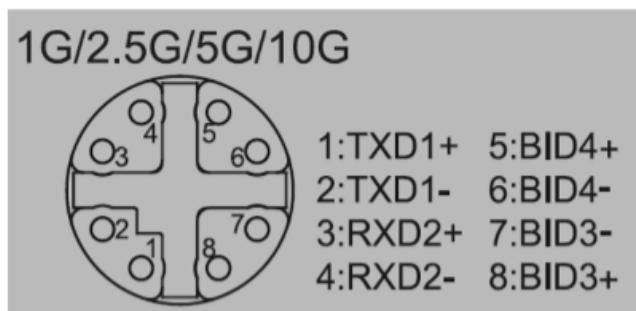
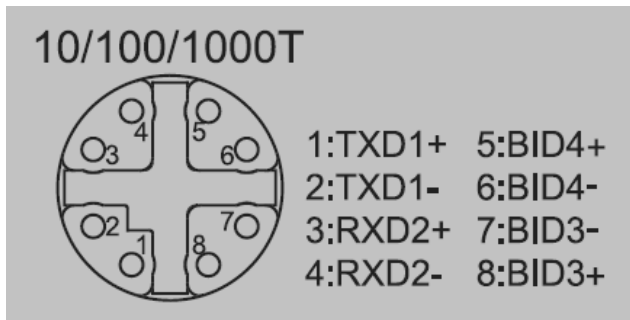

- Make sure the direction of connector is correct before you connect it.

Cable



- Plug connector and screw in clockwise direction to fix it. For push-pull cable, just plug the cable to the connector.

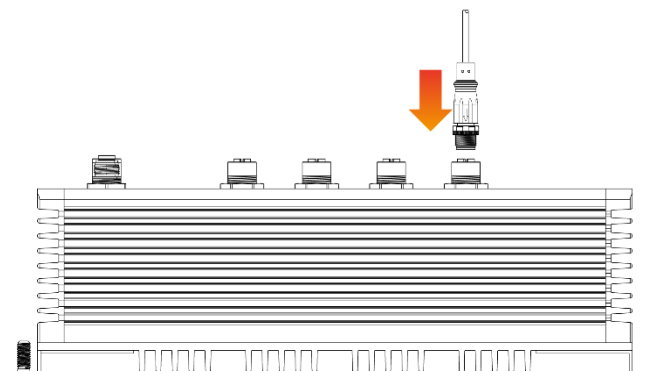

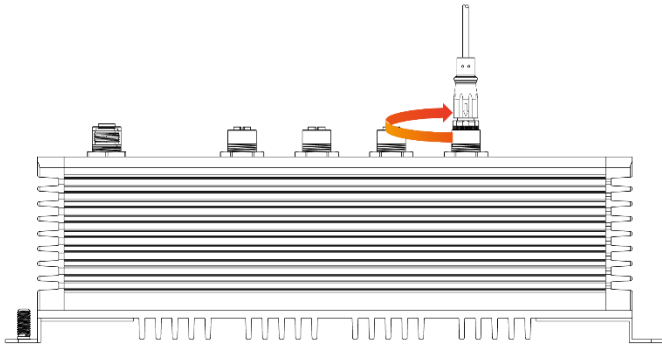

3.6 Q-ODC fiber interface

- Make sure the direction of connector is correct before you connect it.

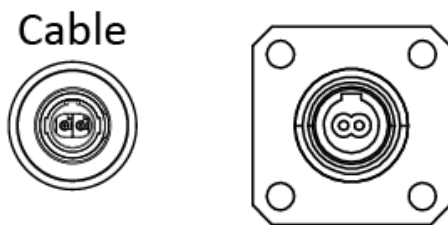

- Plug connector.

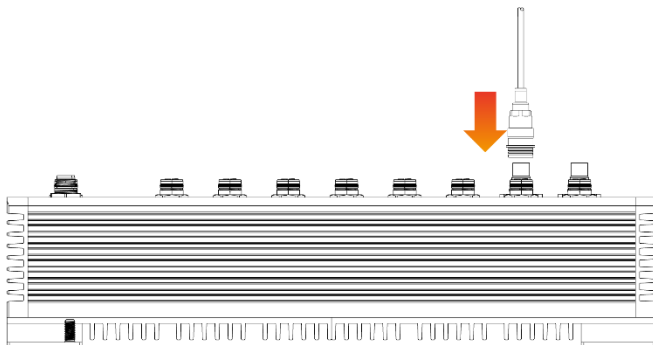

3.6 Ground interface M6 connector

Ground

The chassis is grounded via a separate grounding nut (M6).

Use toothed locking washers for a good electrical connection.

***Note:** The torque should not exceed **14 kilogram-force centimeters (kgf·cm)**, which is approximately **1.4 newton-meters (N·m)**. Applying torque beyond this limit may cause damage to the grounding components.



Ground screw of the switch

Chapter 4 Maintenance

- 1 Check each switch connection and make sure they are all screwed correctly.
- 2 Keep the anti-dust cap on all un-used switch interface
- 3 Access switch via web browser and check the below points:
 - 3.1 Compare the physical connection of the switch port with the switch icon on the web user interface to make sure the connecting status match each other.
 - 3.2 Check the information on the hardware monitor to make sure all conditions are in normal status.
 - 3.3 Check event log to see if there are any abnormal events.

Chapter 5 Console Management

5.1 Connecting to the Console Port

The supplied cable has one M12 4-pole connector end and another RS-232 connector end. Attach the RS-232 connector end to a PC or terminal and the other M12 connector end to the console port of the switch. The connected terminal or PC must support the terminal emulation program.

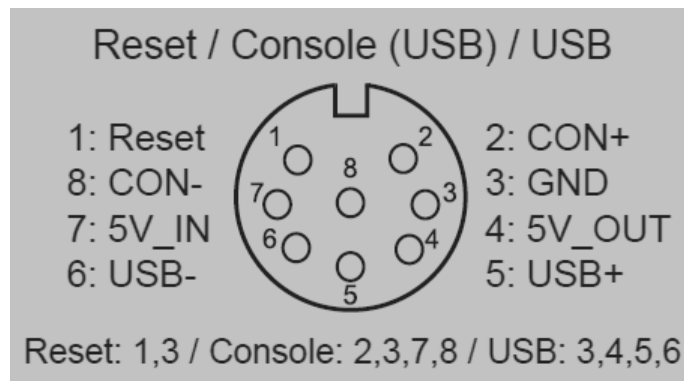

5.2 Login in to the Console Interface

When the connection between Switch and PC is ready, turn on the PC and run a terminal emulation program or **Hyper Terminal** and configure the **communication parameters** to match the following default characteristics of the console port:

Baud Rate: 115200 bps

Data Bits: 8

Parity: none

Stop Bit: 1

Flow control: None

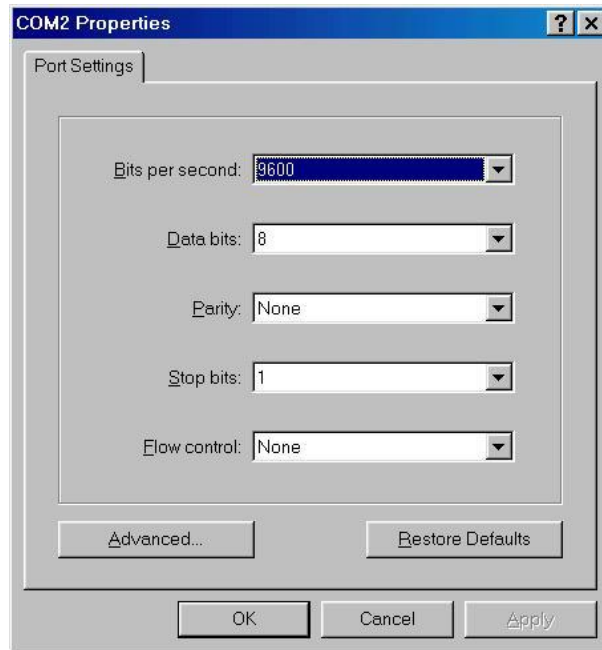

The settings of communication parameters

Having finished setting up the parameters, click 'OK'. When the blank screen shows up, press the Enter key to have the login prompt appear. Key in 'admin' (default value) for both User name and Password (use **Enter** key to switch), then press Enter and the Main Menu of console management should appear. Please see below figure for login screen.

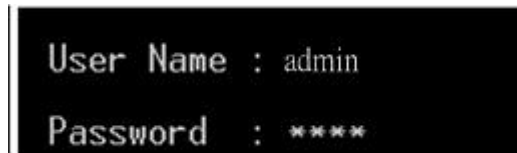

Console login interface

Chapter 6 Reset the Switch

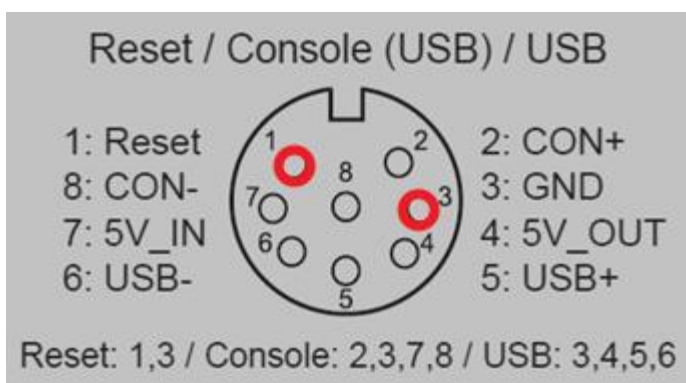

You can reset the Ethernet switch to default configuration by making pin1 and pin3 short for more than 5 seconds.

=====**Notice**=====

For web-based management, please refer to our “Software Management Manual”.
Please [contact us](#) for more information.