

# NXT<sup>®</sup>

NXT Group International Ltd.  
support@nxtlights.com  
nxtlights.com

# FLEXON L

# User Manual



## NXT IS NOW.

NXT LIGHTS | FLEXON L | User Manual | 2026 V2.0





# Contents

- CONTENTS ..... 1**
- INTRODUCTION ..... 2**
- 1. SECURITY WARNING INFORMATION ..... 3**
  - 1.1 ADDITIONAL IP-RATED MAINTENANCE INSTRUCTIONS ..... 5
  - 1.2 SERVICE MAINTENANCE ..... 5
- 2. PRODUCT INTRODUCTION ..... 7**
- 3. MAIN TECHNICAL PARAMETERS ..... 8**
- 4. FEATURES ..... 9**
  - 4.1 GOBO SYSTEM ..... 9
  - 4.2 GOBO REPLACEMENT ..... 10
  - 4.3 FRAMING SYSTEM ..... 14
  - 4.4 ANIMATION WHEEL ..... 15
  - 4.5 PRISM SYSTEM ..... 15
  - 4.6 MOVEMENT ..... 16
  - 4.7 BEAM ..... 16
- 5. PHOTOMETRICS ..... 17**
- 6. CONTROL AND PROGRAMMING ..... 18**
  - 6.1 CRMX (OPTIONAL FEATURE) ..... 18
- 7. PACKAGING AND TRANSPORTATION ..... 19**
  - 7.1 DISASSEMBLE PACKAGING NOTICE: ..... 19
  - 7.2 EQUIPMENT PACKAGING ..... 19
- 8. INSTALLATION REQUIREMENTS ..... 20**
  - 8.1 EQUIPMENT INSTALLATION ..... 21
  - 8.2 HANGING INSTALLATION DIAGRAM ..... 21
- 9. POWER AND SIGNAL CONNECTIONS ..... 23**
  - 9.1 POWER AND SIGNAL SOCKETS ..... 23
  - 9.2 POWER CONNECTION ..... 23
  - 9.3 SIGNAL CONNECTION ..... 25
- 10. REGULAR MAINTENANCE ..... 26**
  - 10.1 FAN MAINTENANCE ..... 28
- 11. CONTROL PANEL AND MENU ..... 29**
  - 11.1 PANEL INTRODUCTION ..... 29
  - 11.2 SYSTEM MENU ..... 30
- 12. DMX CHANNEL LIST ..... 33**

## Introduction

- This manual contains important information on safe use and installation. Please read it carefully and follow the requirements for operation and installation. Please keep this manual properly.
- Each unit is tested and properly packaged before leaving the factory. The operator should strictly follow all safety warnings and operating instructions in the manual. Any malfunction or damage caused by misuse or neglect of the manual will not be covered under our company's warranty or liability.
- The manufacturer shall not be liable for any resulting damages caused by the non-observance of this manual or any unauthorized modification to the device.
- The information in this manual is for reference. In case of any discrepancy, the actual product specifications shall prevail. Any changes will not be notified separately, and our company reserves the right of final interpretation.
- Each unit has undergone thorough testing before shipment and has been delivered in optimal working condition. Upon receiving your device, carefully inspect the packaging for any visible signs of damage that may have occurred during transit. If you notice any damage to the box, proceed to examine the device itself to ensure it has not been affected.
- Additionally, verify that all necessary accessories required for installation and operation are included in the package. If any parts are missing or if the product has been damaged, please contact customer support for further instructions.
- Important: Do not send the device back without first consulting the support team. Also, avoid discarding the original packaging materials, as they may be useful for future transportation or storage.

SAFETY WARNING	INSTALLATION & HAZARDS
 <p><b>High-Power LED Fixture</b> <b>Risk Group 2</b> Not for household use.</p> <ul style="list-style-type: none"> <li>• This device emits intense LED radiation.</li> <li>• Avoid direct eye exposure – risk of serious injury.</li> <li>• Do not stare into the beam.</li> <li>• Flashing light may trigger epileptic seizures.</li> <li>• Use only in controlled environments by trained personnel.</li> <li>• Use in accordance with manufacturer safety instructions.</li> </ul>	 <ul style="list-style-type: none"> <li>• Min. distance to illuminated objects: 10 m</li> <li>• Min. distance from flammable material: 3 m</li> <li>• Risk of fire if misused.</li> <li>• Exterior surface temperature: 76°C</li> <li>• Service only by qualified technicians.</li> <li>• Follow EU Directive EN 62471, EN 60598-1.</li> </ul>

## 1. Security Warning Information



**Attention! Please read the safety requirements information in this section carefully before installing, powering on, operating, or repairing the lighting fixtures.**



- This product is for professional use and is not suitable for other purposes.
- After receiving the lighting fixtures, please check if the packaging is complete and unpack to check if the equipment has been damaged due to transportation. If there is any damage caused by transportation, please do not use this lamp and contact local technicians or manufacturers as soon as possible.
- When transporting again, please use the original packaging materials.
- If there is obvious damage to the machine casing, it should be replaced in a timely manner.
- When hanging lamps, it is necessary to verify that the hanging equipment can withstand more than 6 times the weight of the lamp. After installation, it is necessary to verify that the lamp cover and installation buckle are secure and undamaged. At the same time, a safety cable should be used as an auxiliary safety for the lamp and fixed on the truss.
- The light source inside this luminaire should be replaced by the manufacturer, its service agent, or a similarly qualified person.
- If you have any other questions about how to safely operate the equipment, please contact our technical personnel or call our service hotline.
- This product has a protection level of IP65 and can be used both indoors and outdoors.
- Do not use the fixture in marine or high-salinity environments. Salt exposure can cause corrosion and permanent damage. Any salt-related damage is not covered under warranty.
- Avoid exposing the lens to direct sunlight or other strong light sources, which may cause the lens to focus and burn out internal components.
- Lighting fixtures should be kept clean and avoid prolonged use in overheated or dusty environments to prevent contact with chemical liquids.
- When using the product, attention should be paid to avoiding serious or fatal injuries caused by fire, heat, electrical shock, and ultraviolet radiation. Before powering on or installing, read the instruction manual first. Follow the safety precautions for operation and pay attention to the warning signs on the instructions and equipment.
- Only professionals are allowed to install, operate, and maintain lighting fixtures, and strictly follow the procedures stated in the operating instructions.
- Do not look directly at the light source.



- Do not connect this device to any dimmer.
- If visible damage occurs to the protective casing, lens, and display screen on the lighting fixture, it is considered as damage to the point of loss.
- Please do not place any filters or other items at the light outlet, and do not replace non original parts.
- The minimum safe illumination distance of the lamp is 10m.
- Before installation, please confirm that the power supply voltage used matches the voltage indicated on the light fixture. Each lighting fixture should be properly grounded and electrically installed according to relevant standards.
- Please disconnect the power before repairing or cleaning the equipment.
- During the operation of the lighting fixtures, touching the wires is prohibited to prevent electric shock.
- If the external soft cable or wire of this lamp is damaged, the wire should be replaced by the manufacturer, its agent, or a similarly qualified person to avoid danger.
- Avoid flammable liquids, water, or metal conductors from entering the interior of the lamp to prevent electric shock or fire. If any foreign objects enter the lamp, immediately cut off the power supply.
- When multiple lamps are operated in series, the signal lines can be connected in multiple ways, but the power supply must be connected separately.



- The lighting fixtures work normally at -20°C to 45°C. When replacing any components or accessories in the equipment, ensure that the power is disconnected to prevent electric shock and injury.
- The maximum surface temperature of the lamp during operation can reach 76°C, please do not touch it with bare hands.



- The lighting fixtures must be installed in a sufficiently ventilated area, at least 0.5m away from adjacent surfaces, to ensure that no ventilation holes are blocked.
- Do not install the lighting fixtures directly on flammable objects.
- The minimum distance between all outer surfaces of the lamp and combustible materials is 0.5m.



- The FLEXON L is covered under standard manufacturer warranty terms.
- Warranty Exclusions:
  - Damage due to improper installation, handling, or opening by unauthorized personnel
  - Moisture ingress due to missing or damaged gaskets or filters
  - Corrosion or failure caused by operation in high-salinity environments (e.g. sea air, salt fog)





- LED lifespan degradation due to excessive ambient temperature or poor ventilation
- Damage due to incompatible power supply or DMX wiring.
- Always follow maintenance and environmental guidelines to preserve warranty coverage.
- To prevent electrical hazards, always connect the fixture to a properly grounded AC outlet protected by a residual-current device (RCD).
- Never connect the fixture to a dimmer pack or an unregulated power source.
- The manufacturer is not liable for any damage, injury, or adverse effect resulting from improper use, unauthorized modification, or direct exposure to the light beam.

## 1.1 Additional IP-Rated Maintenance Instructions

- Ensure all gaskets and seals are **clean and undamaged** before closing any part of the fixture.
- Always **tighten all locking screws and seals properly** to maintain the IP65 rating.
- After any maintenance involving the **optical or electronic compartments**, perform a **pressure test or moisture test according to the IP65 standard** if available.
- Avoid **high-pressure water jets** when cleaning the exterior.
- Replace any **visibly worn or cracked seals immediately** using manufacturer-approved parts.
- Regularly **inspect vent filters** and replace if clogged or deteriorated.

## 1.2 Service Maintenance

### IP-Rated Maintenance Instructions

**This fixture is IP65 rated. To maintain this protection level:**

- Only certified service technicians are authorized to open the fixture.
- If the fixture is opened by an unauthorized party, or if it is reassembled without passing an IP integrity test, the warranty is void.
- All gaskets and seals must be clean, intact, and properly resealed during reassembly.
- Failure to follow these procedures will compromise the fixture's protection and void the warranty.
- This product is IP65-rated and designed for outdoor use. However, if the fixture is opened for maintenance, it must be properly resealed and pressure-tested according to factory specifications. Only service operations performed by authorized NXT technicians or official service centers are allowed.
- Improper sealing or unauthorized access will void the warranty.
- For detailed service and warranty conditions, refer to section 10 of this manual.



### **Service Safety Regulations**

- Servicing of internal components, especially optical and laser-related parts, must only be performed by qualified personnel.
- Unauthorized access to internal sections may result in exposure to high-intensity light or electrical hazards.

### **Silica Gel Maintenance**

- This fixture contains an internal silica gel pack to prevent condensation. Inspect the pack annually and replace it if it appears saturated or after any internal access.  
Always reseal the fixture immediately after replacing the pack.

## 2. Product Introduction

### 2.1 Exterior dimensions of lighting fixtures – 450 × 316 × 818mm

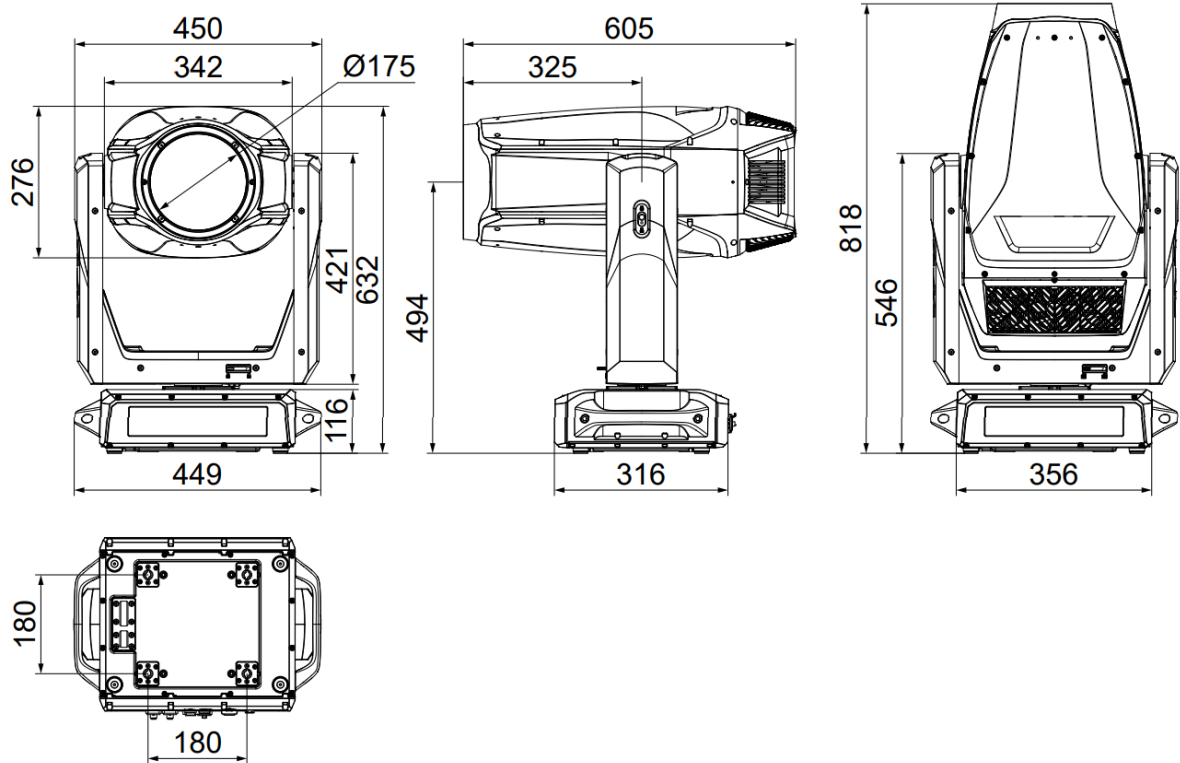

### Mechanical Specifications

- Weight: 43.6 kg
- Carton size: 102 × 60.5 × 47.5 cm
- Net Weight: 51.6 kg

### 2.2 Packaging accessories

- Omega bracket - 2 pcs
- Safety Cable - 1 pc
- Power Cable - 1 pc

## 3. Main technical parameters

### Electrical parameter:

- Rated input voltage: AC 100V-240V~ 50Hz/60Hz
- Rated power of the entire fixture: 1600W
- Power factor: 0.99
- Input Current: 7.23A @220V

### LED lifespan:

- ~ 20000 hours
- This figure was determined under controlled laboratory test conditions and is provided as an estimate only. The actual useful life of the LED module depends on multiple variables, including but not limited to ambient temperature and humidity, mains voltage stability, duty cycle (frequency of on/off switching), thermal management (ventilation/fan performance), control protocols and dimming behavior. This statement is not a guaranteed minimum lifetime.

### Color system

- Color temperature: 6500K
- CRI (Ra): 70 in Performance LED Engine Mode
- CRI 95 (Ra) / 95 (R9) in High CRI LED Engine Mode
- Color wheel: 5 colors + open
- Color Mixing: CMY
- Linear CTO, TINT

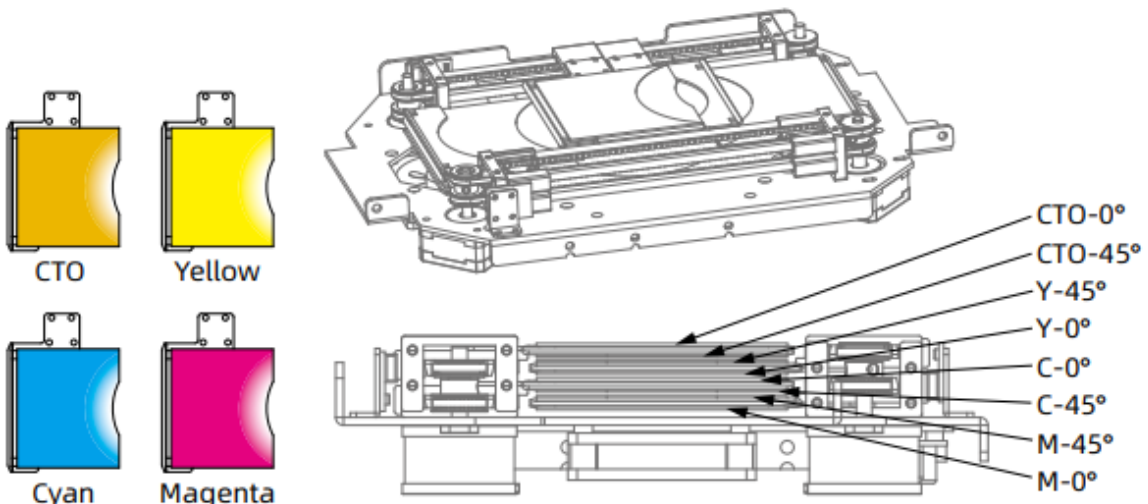
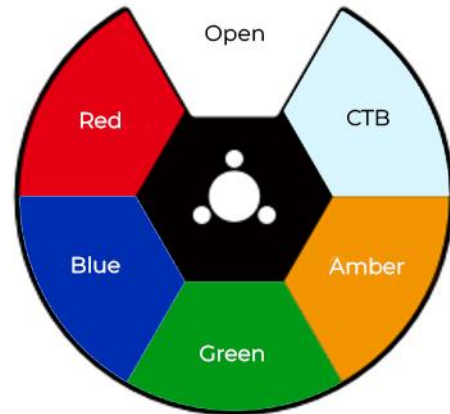

## 4. Features

### 4.1 Gobo system

- Gobo outer diameter: 30mm
- Internal diameter: 25mm
- Thickness: 1.1mm

Rotating Gobo wheel 1

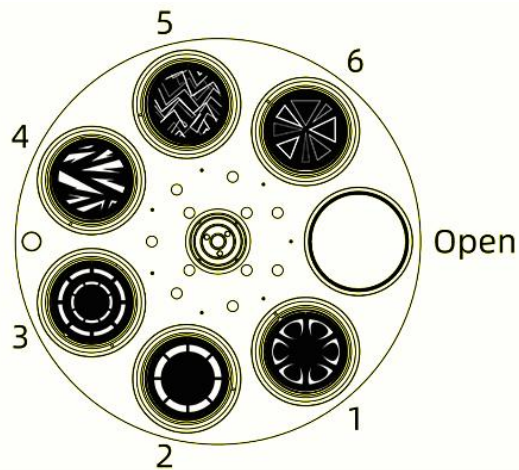

Rotating Gobo wheel 2

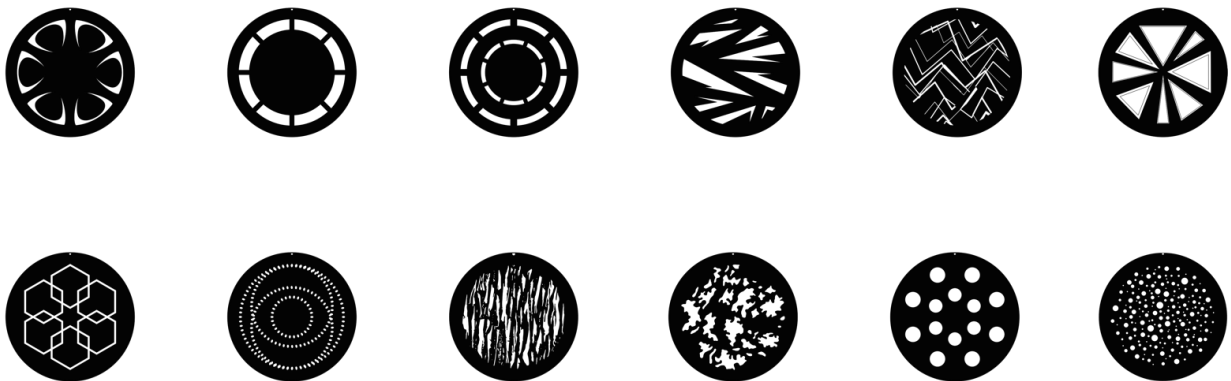
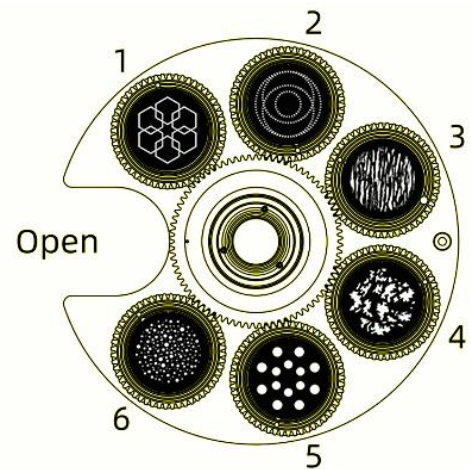

## 4.2 Gobo Replacement

### Gobo wheel 1

a) Remove the two screws at location A, unplug the power and signal adapter cables, and extract the Gobo component.

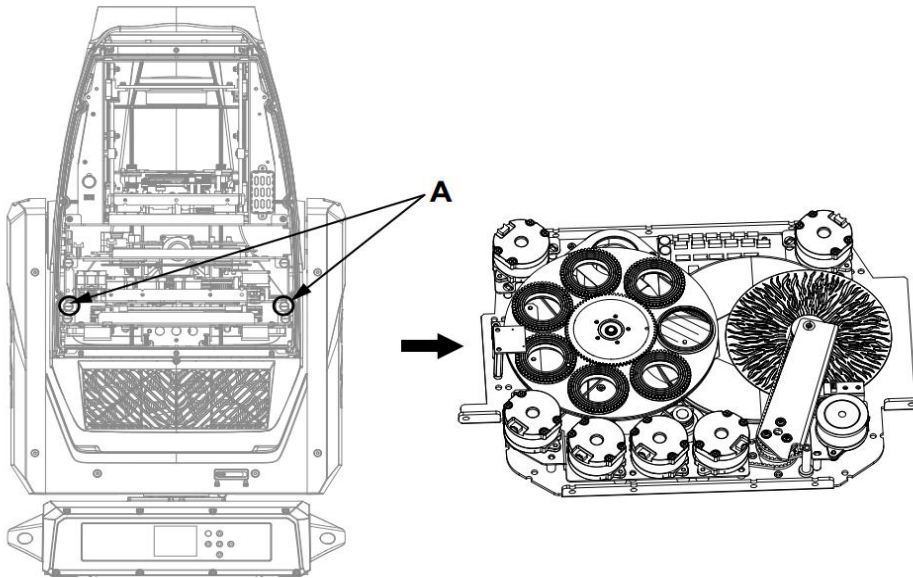

b) As shown in B, gently lift the driven wheel from the edge upwards from the front of the pattern plate and slowly pull it out to remove a single pattern seat.

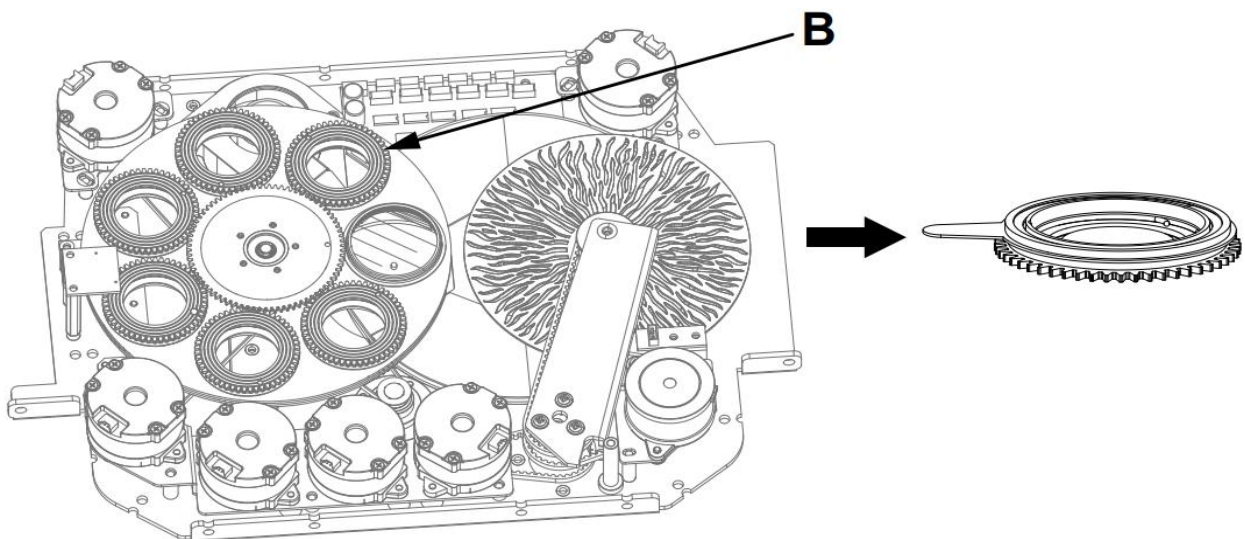

c) Use tweezers or other small grippers to remove the snap spring at point C (If the pattern piece is coated with glass glue for fixation, please use a professional cleaning agent to remove the glass glue before removing the snap spring to avoid damaging the gobo).

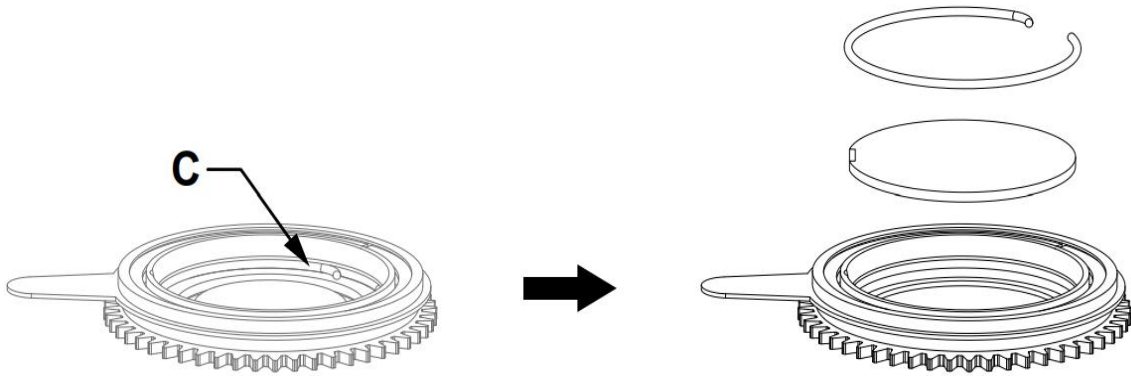

d) When assembling the gobo, avoid touching it directly with your hands. As shown in D, align the notch of the gobo with the recess of the driven wheel component (the coating surface of the gobo should face the light source).

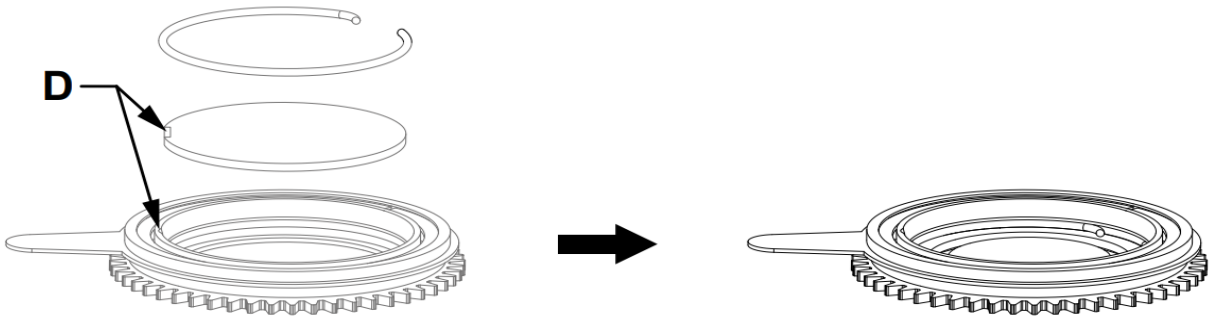

e) Insert the gobo holder into the drive wheel assembly, as shown in E, and reinstall the gobo holder in the order it was removed. The positioning point of the gobo holder should be aligned with the positioning point of the driving wheel. After installation, simply reinstall the gobo wheel component onto the light fixture.

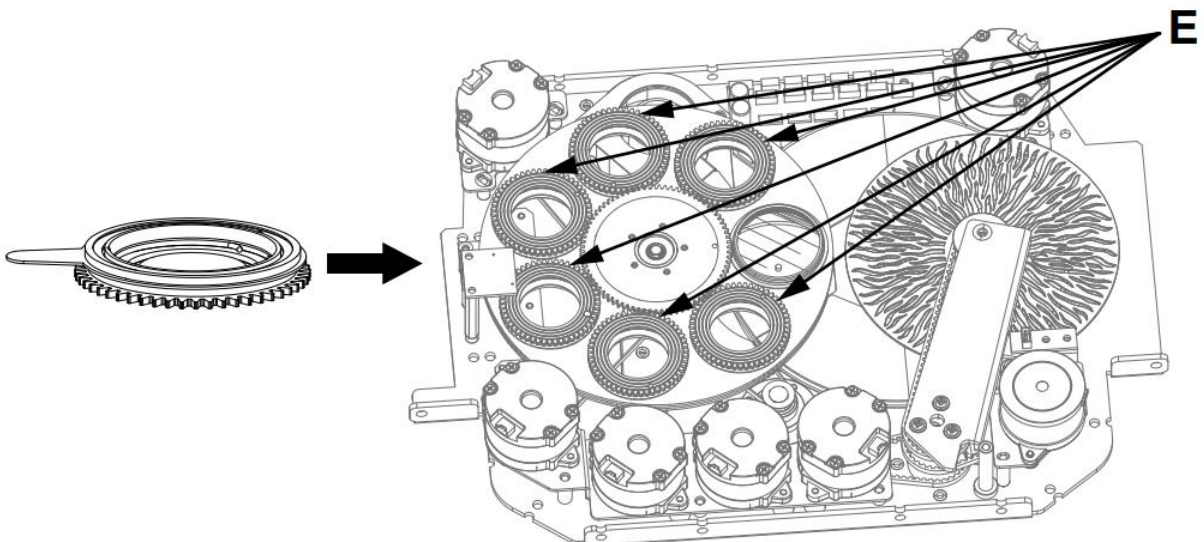

## Gobo wheel 2

a) Unscrew the two screws on the location F on the front side of the gobo wheel component and remove the magnetic sensing plate. Loosen the 6 screws at point G and loosen the Gobo self-rotating belt (to facilitate the next step of removing the Gobo wheel component).

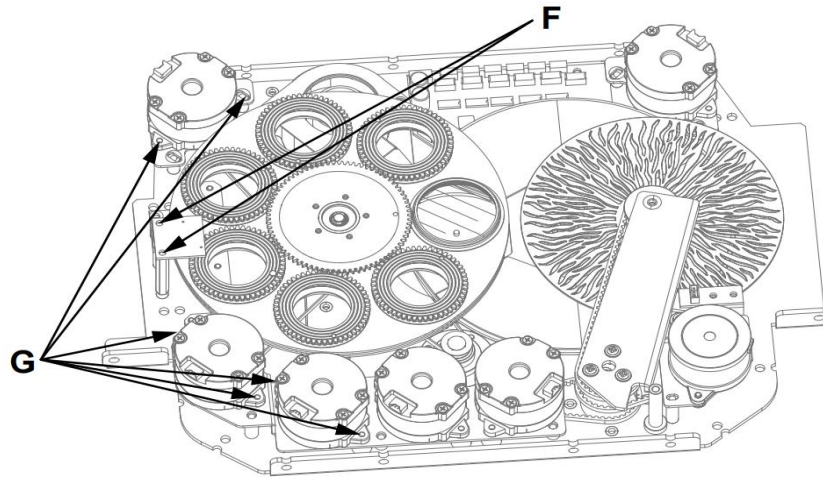

b) Reverse the components and loosen the 3 screws at H to loosen the belt. Unscrew the 4 screws at position I again to remove the gobo wheel component of the pattern disk.

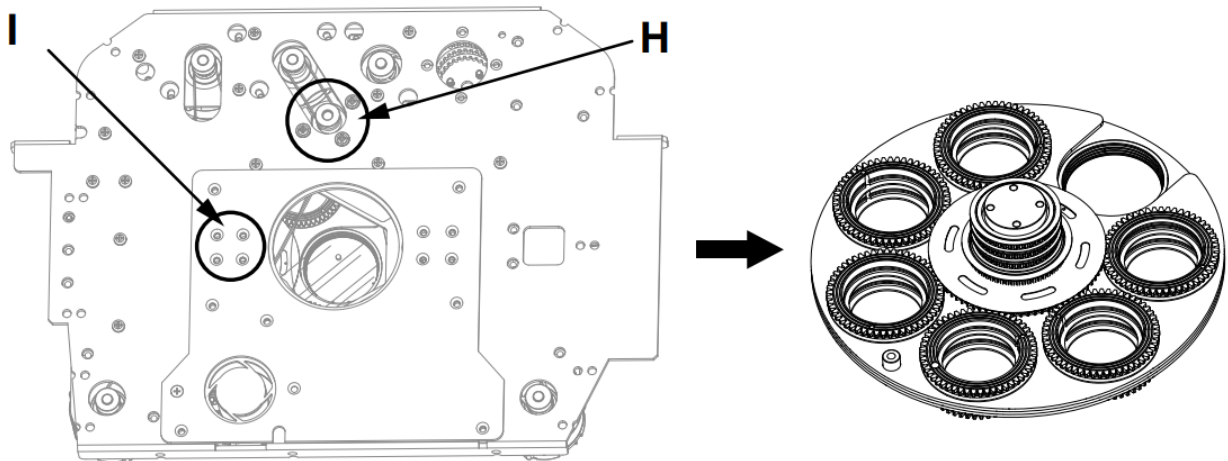

c) As shown in J, gently lift the gobo holder from the edge of the gobo wheel 2 and slowly pull it out to remove a single gobo holder.

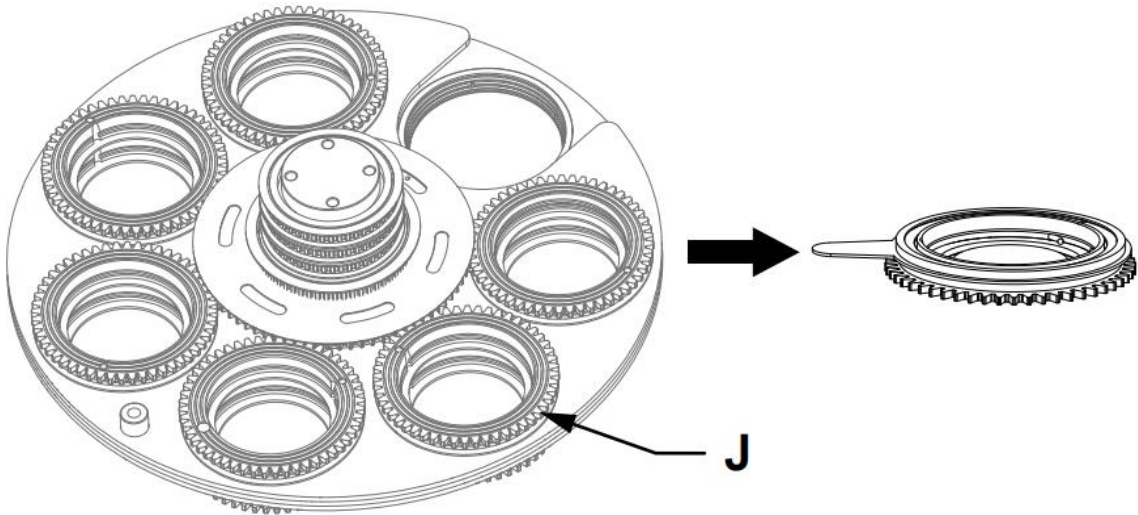

d) Please refer to page 10 for the replacement method of Gobo.

e) Insert the gobo wheel into the drive wheel assembly, as shown in K, and reinstall the gobo holder in the order it was removed.

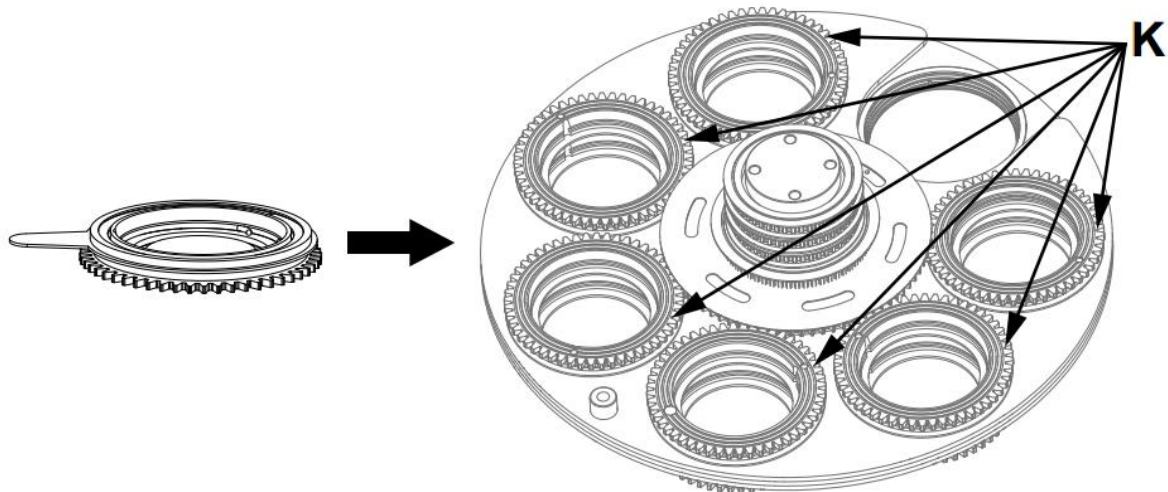

f) After installation, simply reinstall the gobo wheel component onto the light fixture.

## 4.3 Framing system

4 motorized framing blades allow fast and smooth beam shaping, each blade's cut angle and position is individually controllable. Any single blade can fully block the light, and the entire framing module can rotate  $\pm 60^\circ$ .

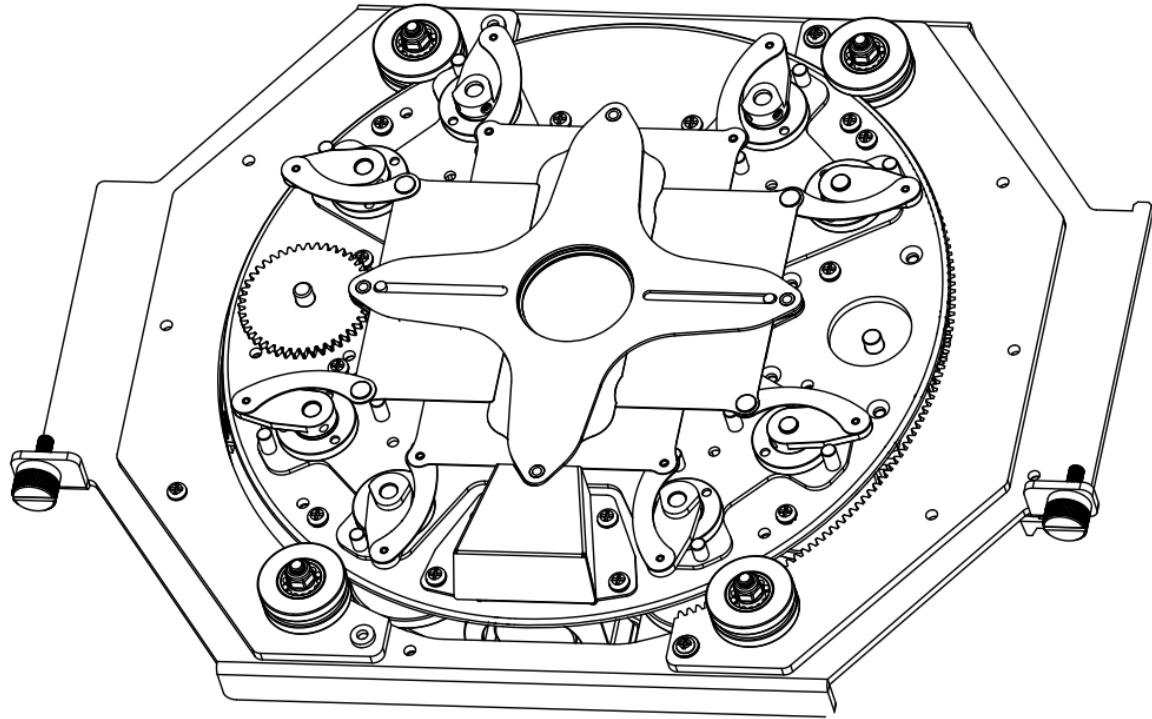

## 4.4 Animation Wheel

The fixture includes an independent animation wheel for dynamic effects, enabling additional motion textures.

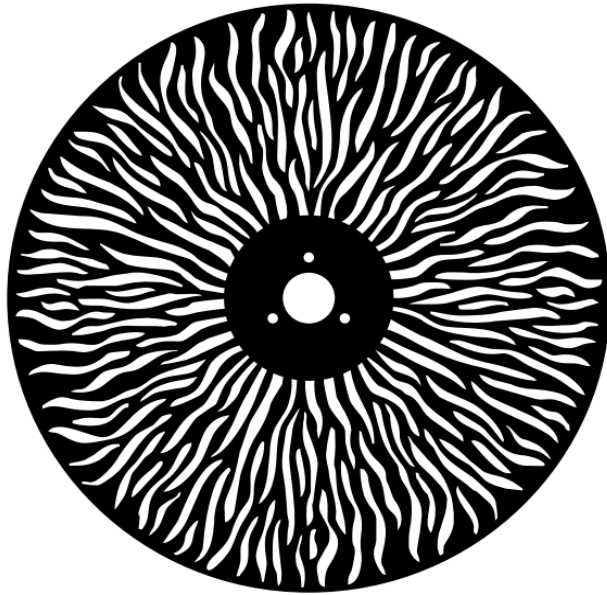

## 4.5 Prism system

One 6 faced linear and one 4 faced circular prism for beam multiplication. These prisms can be inserted for aerial effects.

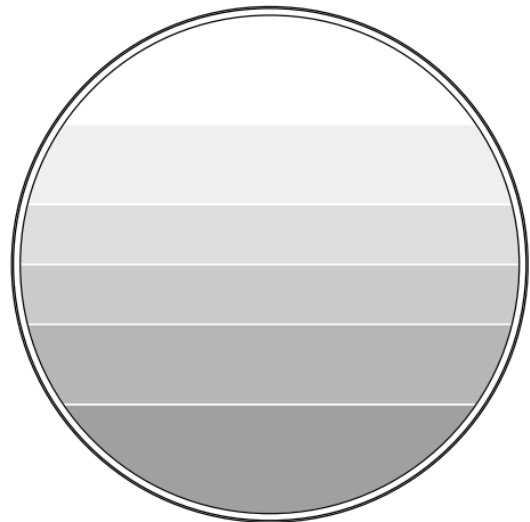
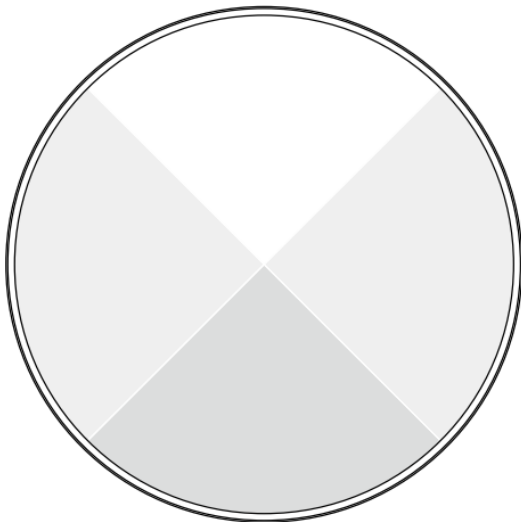

## 4.6 Movement

Pan movement: 540° 8-bit/16bit

Tilt movement: 270° 8-bit/16bit

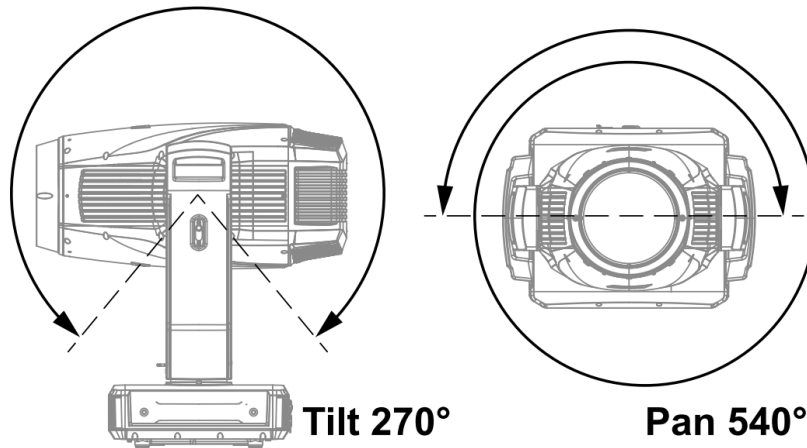

## 4.7 Beam

- **Electronic strobe:**  
1-25 Hz
- **Frost filters:**  
The fixture is equipped with two independent frost filters (Light Frost and Heavy Frost).  
Both filters are separately controllable and provide linear adjustment for smooth transitions from clear output to full frost effect.
- **Iris:**  
High speed motorized iris

## 5. Photometrics



### FLEXON L | Photometric Report

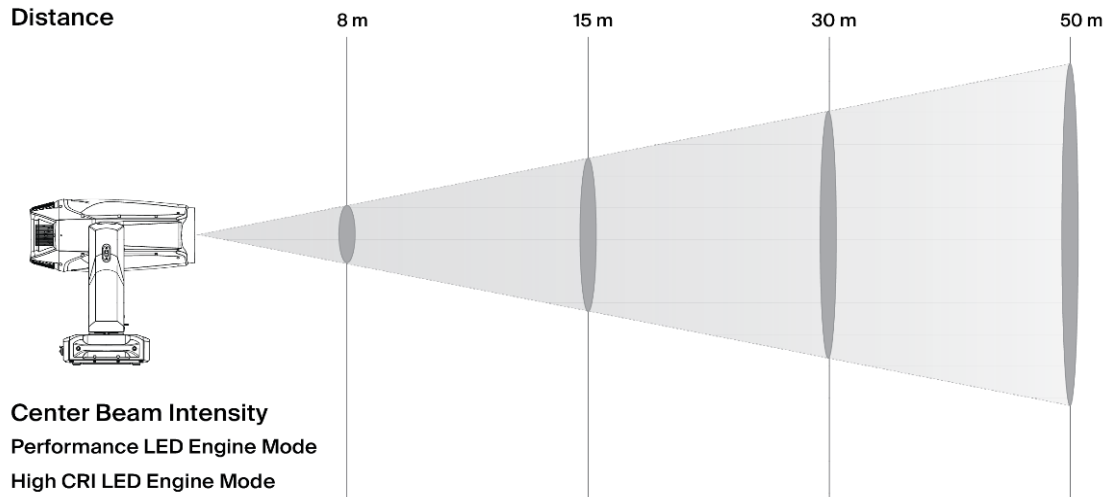

Distance (m)	8		15		30		50	
Beam opening	Lux	Diameter (m)	Lux	Diameter (m)	Lux	Diameter (m)	Lux	Diameter (m)
6° Performance	48828	0.84	13889	1.57	3472	3.14	1250	5.24
50° Performance	1840	7.46	523	13.99	131	27.98		
6° High CRI	31406	0.84	8933	1.57	2233	3.14	804	5.24
50° High CRI	1210	7.46	344	13.99	86	27.98		

NXT Group International Ltd. | support@nxtlights.com | nxtlights.com

### Optical system

**Beam angle:** 6 - 50°

**LED Module:** 2 x 1400W Cool-White LED

**LED refresh frequency :** 1200Hz-25kHz

**Output luminous flux :**

55,000 lm (Performance LED Engine Mode)

33,000 lm (High CRI LED Engine Mode)



## 6. Control and Programming

Control channels: 46ch (Standard) / 60ch (Extended)

Protocol: DMX512, RDM, Art-Net, sACN CRMX

Data connections: 5-pin XLR (DMX) In/Out, and RJ45 network (Art-Net/sACN) In/Out.

### Adjustable Fan Modes

The fixture includes selectable fan modes via the control menu:

- AUTO – fan speed adjusts to internal temperature
- HIGH – maximum cooling
- SILENT – reduced speed for quiet environments
- ULTRA SILENT – lowest noise, limited thermal output
- STUDIO MODE – Lowest noise, fix limited brightness output

### 6.1 CRMX (Optional Feature)

An optional Wireless DMX module is available for this fixture.

This feature is not included by default and must be ordered separately from the manufacturer.

## 7. Packaging and Transportation

### 7.1 Disassemble Packaging Notice:



After receiving the fixture, please unpack and check for any damage caused by transportation. If there is any damage caused by transportation, please do not use this fixture and contact the local technical personnel or manufacturer as soon as possible.

### 7.2 Equipment packaging

1. Before disconnecting the power supply, dim the fixture to 0% and allow it to cool down for several minutes while still powered on.
2. Once sufficiently cooled, disconnect the power completely. Never package or transport the fixture while it is still hot.
3. Do not place wet, snow-covered, or moisture-exposed fixtures into the flight case. Always dry and clean the surface before packaging. Moisture trapped inside the case may lead to corrosion or electrical damage, which is not covered under warranty.
4. Before storing or transporting the fixture, make sure all power and signal connectors are securely closed using the provided protective caps. This prevents moisture, dust, or corrosion from entering the connectors. Failure to close the connectors properly before storage or transport may result in damage not covered by warranty.
5. Before lifting or transporting, ensure that both PAN and TILT locks are securely engaged. Transporting the fixture without locking may cause mechanical damage not covered by warranty.
6. Flight cases may be stacked at most two high, and must remain upright (do not flip over).
7. NXT Group International Ltd. shall not be held responsible for any damage caused by improper packaging, unsecured transport, or failure to follow these procedures.
8. When not in use, store the fixture in a dry, clean, and dust-free environment, within a temperature range of -10°C to +45°C. Avoid locations exposed to condensation, salt, or high humidity. The fixture must be kept upright during storage and protected from vibration or mechanical shock.

## 8. Installation Requirements

The lighting fixtures can be installed on the stage or in any orientation on the truss, and the clamps can be quickly and easily locked onto the truss.



**Warning!** The lighting fixtures must use 2 clamps to secure the device and each clamp must be secured with a quarter-turn lock. always attach a safety cable to the designated safety attachment point on the base, do not attach the safety cable to the carrying handle.

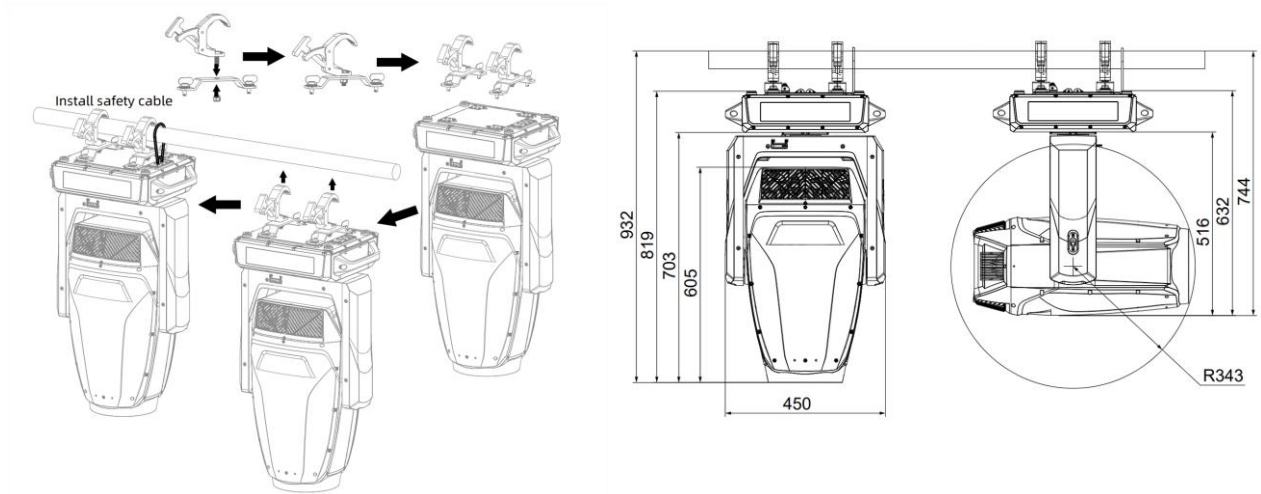

## 8.1 Equipment installation

1. Before installation, it is necessary to verify that the clamp and safety cable are not damaged, and that the supporting structure must withstand at least 6 times the combined weight of the fixture and its accessories (cables etc.).
2. Attach the quick-lock clamps to the bottom of the fixture. Insert each clamp into the mounting slot on the base and lock it by turning 1/4 turn clockwise. Repeat for the second clamp.
3. Installation must be carried out exclusively by trained and qualified personnel in accordance with local safety regulations. Improper installation may result in injury, equipment damage, and will void the product warranty. After mounting but before powering the fixture, release the PAN and TILT locks. Operating the fixture with engaged locks may cause permanent motor or gear damage, which is not covered by warranty.
4. During operation, the fixture's housing can reach elevated temperatures. Do not block any ventilation openings or cooling fans during operation.
5. NXT Group International Ltd. assumes no responsibility for any accidents, injuries, or damage resulting from improper installation, mounting failure, or incorrect use of safety cables and clamps. Always use certified safety cables and clamps rated for the fixture's load. Never suspend the fixture using handles or non-load-rated components.

## 8.2 Hanging Installation Diagram

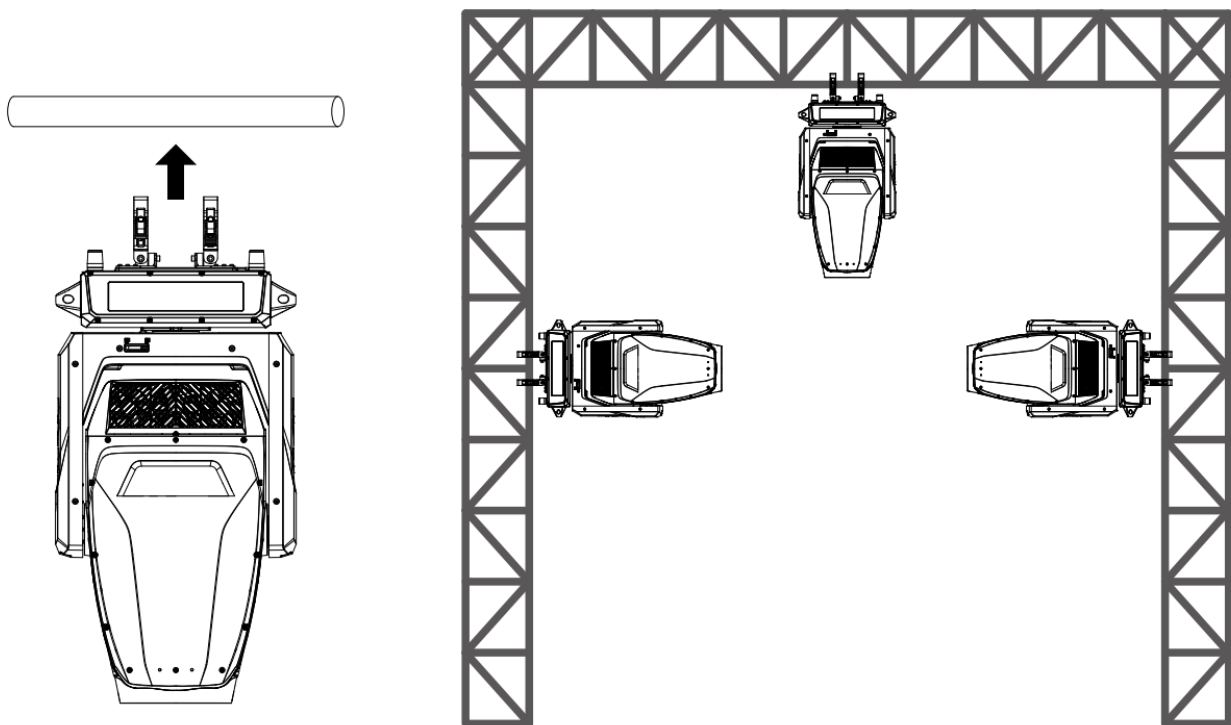



## Reminder: External beam source may damage internal lighting fixtures

Direct external beams, such as sunlight, intense stage lighting, or lasers, may penetrate the lens or reflect on the mirror and cause severe internal damage to the fixture. This risk is inherent to all professional lighting equipment, not only NXT products.

To reduce this risk, always observe the following precautions:

- Do not expose the fixture's lens or mirror to direct sunlight, strong light beams, or lasers at any time, including during unpacking, installation, operation, or shutdown.
- Never aim the beam of this fixture directly into another lighting fixture.

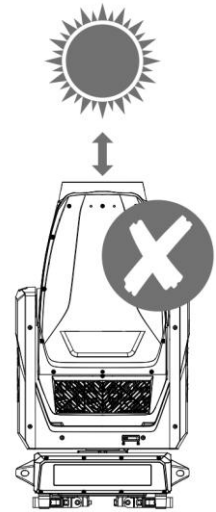

Although such damage cannot be entirely prevented in all situations, following these precautions will significantly reduce the risk. Damage caused by external beams is not covered by warranty.

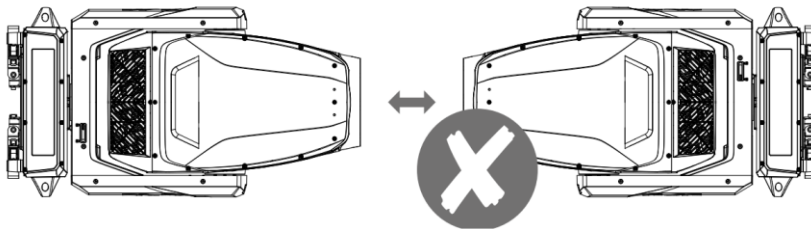

## 9. Power and Signal Connections

### 9.1 Power and Signal Sockets

1. Breather valve
2. Power socket (TRUE1)
3. DMX 5-pin XLR female
4. DMX 5-pin XLR male
5. RJ45 network in
6. RJ45 network out

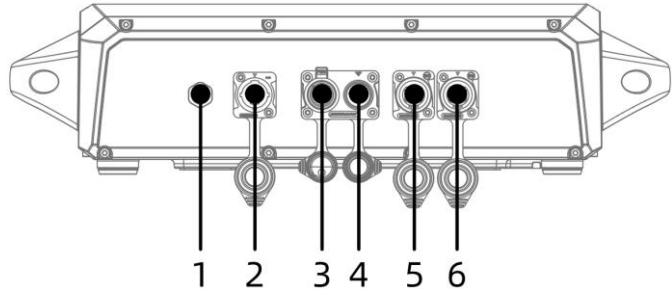

### 9.2 Power Connection

#### Connection method:

- L (Live) - brown wire
  - E (Earth) - yellow/green dual color wire
  - N (Neutral) - Blue wire
- When connecting the power supply, please note that the voltage and frequency of the power supply must match the voltage and frequency marked on the light fixture. Although the PowerCON TRUE1 connectors support daisy-chaining, the maximum output current on the Power Out connector is limited to 4A.
  - We strongly recommend connecting each fixture to a dedicated power source to ensure proper power distribution, safety, and warranty protection.
  - If more than 4A is drawn from the output, or if improper cables or connectors are used, any resulting damage is not covered under warranty.
  - The end user or installer is responsible for ensuring that all cabling and loads comply with local regulations and the product's technical limitations.

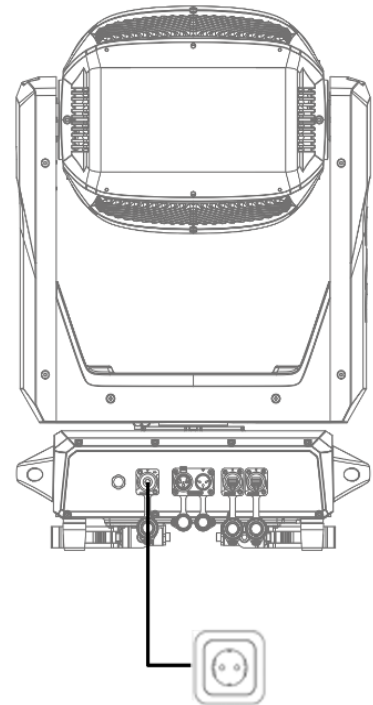

## Attention!



When connecting the power supply, the ground wire (yellow/green dual color wire) must be safely grounded and comply with all relevant electrical installation standards.

This product uses a PowerCON TRUE1 connector. A 2 mm<sup>2</sup> power cable can safely supply one fixture (240 V).

## Warning!



- Do not connect too many fixtures or overload a single power cord.
- Do not use power cords with damaged insulation layers, and do not place power cords over or under other cables.
- When the fixture is not in use or cleaned, please unplug the power cord.
- Do not forcefully unplug or drag the power cord directly.
- Only certified and undamaged power and signal cables should be used.
- The use of undersized, damaged, or incompatible cables may result in fire, electric shock, or equipment malfunction.
- In such cases, the manufacturer accepts no liability and the product warranty is void.
- Always follow local electrical regulations when installing or powering this device.

**NXT Group International Ltd. is not responsible for any damage, malfunction, or safety incidents resulting from the use of improper power cables, insufficient wire gauges, overloaded circuits, or incorrect daisy chaining. Power connectors and wiring must comply with local electrical regulations and the specifications outlined in this manual. Damage caused by non-compliant power distribution or user error is not covered under warranty.**

## 9.3 Signal Connection

The lighting fixtures are equipped with standard 5-pin DMX and Ethernet (RJ45) In/Out for Art-Net/sACN. Please use DMX512 shielded twisted pair signal cables or CAT5e or better Ethernet cables for connection. The typical connection distance for DMX signal lines is approx. 150 m without amplification. When transmitting signals over long distances, a DMX512 signal amplifier must be added.

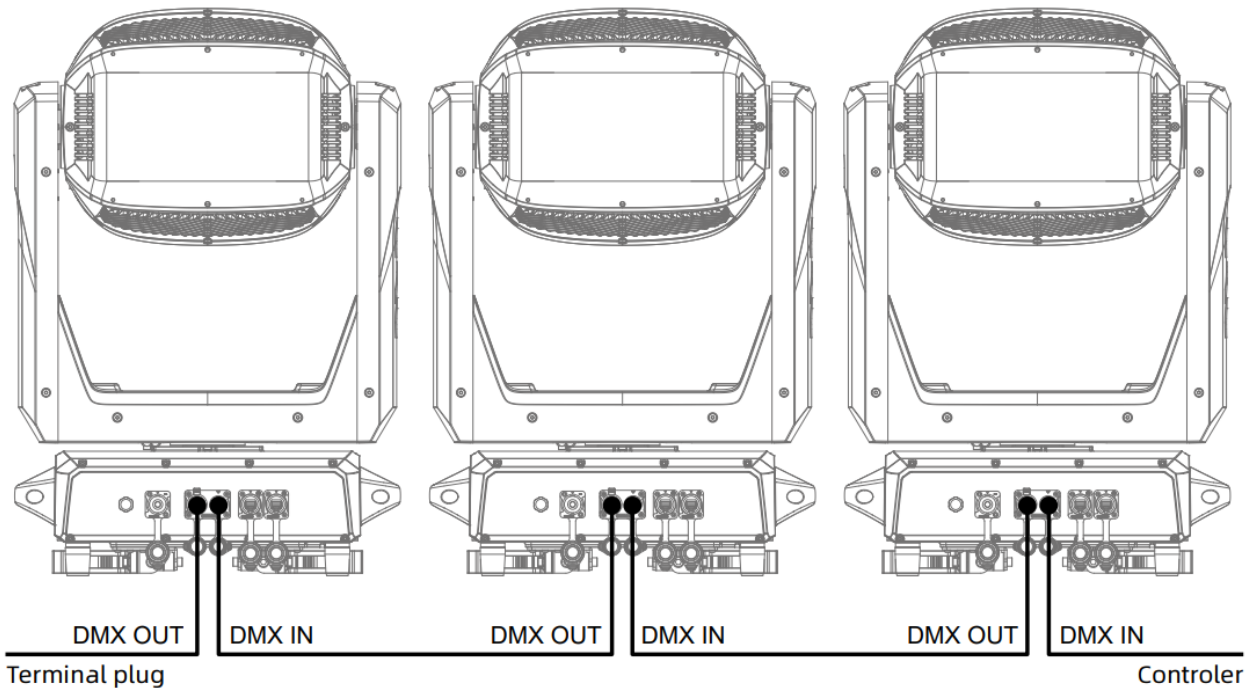

Connect a shielded twisted pair signal cable from the DMX output port of the controller to the DMX input port of the first device, and from the DMX output port of the first device to the DMX input port of the second device, and so on, until all the lamps are connected. Insert a terminator plug into the DMX output of the last fixture in line. Solder a 5-pin XLR terminator (120  $\Omega$ , 1/4 W resistor between pins 2 and 3).

## 10. Regular maintenance

Lighting fixtures require regular cleaning and proper maintenance to ensure reliable operation and long service life. The actual maintenance frequency largely depends on the operating environment and conditions of use.

If you are uncertain or require assistance, please contact NXT technical support or an authorized service center for guidance.

Note: Any maintenance or repair not described in this manual must only be carried out by qualified service personnel authorized by NXT Group International Ltd.



**Attention!** Any damage or malfunction caused by dust, moisture, liquid ingress, oil or fog fluid residue, or any other form of contamination, as well as by improper or abnormal use, is not covered by the warranty.



**Warning!** Before opening any lid, disconnect the power supply. Cleaning optical components requires gentle wiping as the coating surface is prone to scratching. Do not use harsh solvents or abrasive tools, as they may damage the plastic or coating surface.

- All service operations must be carried out exclusively by authorized NXT service technicians or by a service center appointed by NXT Group International Ltd.
- Opening the fixture without authorization, or failing to perform a proper IP integrity test after reassembly, will void both the warranty and IP protection.
- Any water or dust ingress caused by improper sealing or unauthorized maintenance is not covered by warranty.
- When the lens is cracked or otherwise damaged, it should be replaced immediately.
- When noticeable brightness reduction occurs, the LED light source may be nearing the end of its service life and should be replaced by an authorized service.
- If the fixture fails to power on, check whether the main fuse is blown. If it is, replace it with a new fuse of the same rating.
- The fixture is equipped with a temperature protection device. When the internal temperature becomes too high, the protection system will automatically reduce the LED output.
- If this occurs, check whether the cooling fans are operating normally and ensure that the fans and air vents are free of dust. Identify and fix any issues before using the fixture again. Only qualified technicians should perform these internal checks and maintenance.
- To ensure smooth movement of the motorized lens, lubricate its guide rails approximately every three months.

- Use a high-quality, high-temperature resistant grease, and apply sparingly to avoid contaminating nearby components.
- Whenever the fixture is opened for inspection or service, it must be resealed and verified for IP65 integrity before use.
- Operating the unit without confirming proper sealing may lead to water or dust ingress and void the warranty.
- Always ensure that all gaskets, screws, and covers are correctly positioned and tightened.
- Firmware updates may occasionally be released to improve functionality or performance. Only authorized NXT technicians or approved distributors are permitted to install firmware updates. Installing unofficial or modified software may cause malfunction and will void the warranty.

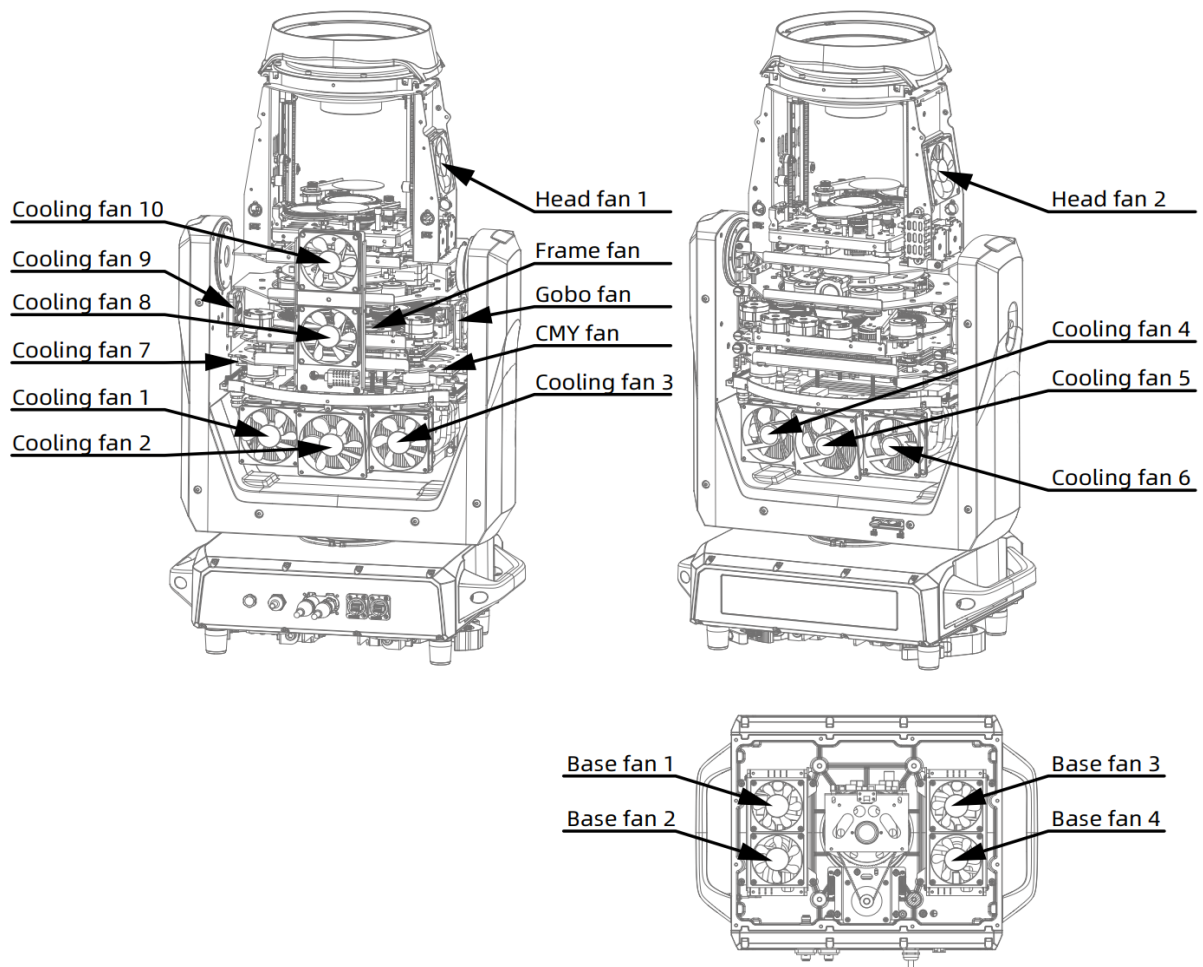



## 10.1 Fan Maintenance

Proper fan maintenance is essential to ensure reliable operation, prevent overheating, and extend the lifespan of moving light fixtures. Over time, dust and dirt can clog fans, reduce airflow, and cause the fixture to overheat or fail. Regular maintenance ensures better performance and longer life.

### Maintenance Schedule

Environment	Inspection	Cleaning
Indoor (clean conditions)	Every 3 months	Every 6 months
Outdoor or dusty environments	Monthly	Every 3 months
Touring / high-duty use	Before each tour	After each tour

**Important:** Always disconnect power and allow the fixture to cool before servicing.

### Required Tools

- Soft brush or small anti-static brush
- Compressed air (non-static)
- Lint-free cloth
- Isopropyl alcohol (for stubborn buildup)
- Screwdriver (if access panels are secured)

### Cleaning Procedure

1. **Power Off:** Disconnect the fixture from power and let it cool completely.
2. **Access Fans:** Remove the necessary covers to expose internal
3. **Dust Removal:** Use a brush or compressed air to clean blades, vents, and surrounding areas.
4. **Wipe Down:** If needed, gently clean fan blades with a cloth dampened with isopropyl alcohol.
5. **Inspect Function:** Spin the fan manually—it should move smoothly and quietly.
6. **Reassemble:** Secure all covers and reconnect any internal fan connectors.

### **Disposal and Environmental Responsibility**

This product contains electronic components and must not be disposed of with household waste.

At the end of its service life, please follow local regulations for the collection, recycling, or disposal of electrical and electronic equipment.

Proper recycling helps prevent environmental damage and promotes sustainable use of resources.

## 11. Control Panel and Menu

### 11.1 Panel Introduction



The fixture features a 2.8" LCD display. The control panel has an internal rechargeable battery, allowing menu navigation (address setting and other options) without mains power.

- When the fixture is not connected to power, press and hold the MODE (≡) button for approximately 3 seconds until the menu system activates and appears on the display.
- When on the main display screen (not in the menu), press either the LEFT or RIGHT arrow key once to rotate the display 180°.
- This allows the screen to be viewed correctly when the fixture is mounted in different orientations.
- Press the MODE (≡) button to enter the main menu and view or modify settings. Use the UP, DOWN, LEFT, and RIGHT arrow keys to navigate through the available options.
- Press the ENTER button to confirm your selection and open the corresponding submenu. Each menu item represents a specific function of the lighting fixture (as shown in the table below).
- Within a menu, use UP/DOWN to adjust values (increase or decrease). Press ENTER to save a modification or to enter the next submenu level.
- Press the MODE (≡) button at any time to return to the previous menu or exit without saving.



## 11.2 System menu

Note: The **gray** color block is the default setting value

<b>Main Menu</b>	<b>DMX Address</b>	001 - 512		
	<b>DMX Mode</b>	Standard // 46 CH		
		Extended // 60 CH		
	<b>Network Protocol</b>	ArtNet/sACN/CRMX		
	<b>IP Address</b>	xxx.xxx.xxx.xxx		
	<b>Network Mask</b>	xxx.xxx.xxx.xxx		
	<b>Universe</b>	XXX		
	<b>Settings</b>	<b>Network Switch</b>	Network Switch ON	
			Network Switch OFF	
		<b>CRMX</b>	CRMX Activate	
			CRMX Reset	
		<b>Dimmer Curve</b>	Linear	
			Square Law	
			Inv-Square	
			S-Curve	
		<b>Dimmer Mode</b>	Standard	
			Stage	
			TV	
			Architectural	
		<b>Pan Invert</b>	Pan Invert OFF	
			Pan Invert ON	
		<b>Tilt Invert</b>	Tilt Invert OFF	
			Tilt Invert ON	
		<b>Move Speed</b>	Normal	
		<b>Fan</b>	Auto	
			High	
			Silent	
Ultra Silent				
Studio mode				
<b>FollowSpot Mode</b>		FollowSpot Mode ON		
	FollowSpot Mode P/T Only			
	FollowSpot Mode OFF			
<b>LED Engine Mode</b>	High Power LED Engine			
	High CRI LED Engine			

		CTB Mode	CTB Mode ON
			CTB Mode OFF
		Frequency	1200Hz
			3600Hz
			5000Hz
			10kHz
			15kHz
			20kHz
			25kHz
		Display Backlight	01~60m
		Flip Display	Flip Display ON
			Flip Display OFF
		Screen Lock	Screen Lock ON
			Screen Lock OFF
		Display Flash	Display Flash ON
			Display Flash OFF
		Lost Signal	Hold
			Black
			Auto
	Feedback	Feedback ON	
		Feedback OFF	
	Factory Default	Factory Def. ON	
		Factory Def. OFF	
	Temp. F/C°	Celsius	
		Fahrenheit	
	Reset	Global Reset	
		Pan & Tilt Reset	
Head Reset			
Test	Channel Value	Pan... Tilt...	
	Slave Setting	Slave1, Slave2, Slave3	
	Auto.Prog	Master / Alone	
	Test Channel	Pan... Tilt...	
	Panel Ctrl	Pan =XXX:, Tilt =XXX:	
	Calibrate	Pan =XXX:, Tilt =XXX:	
	Run Scene	Scene1/Scene2....	
	Record Scene	Scene1/Scene2....	

		Edit Scene	Scene 1, Scene 2
		Scene Speed	XXX S
<b>Info</b>	Time.Info	Current	
		Total Time	
		Last Time	
		Clear Last	
	Temp. Info	LED Temp1 :	
		LED Temp2:	
		Heat Temp:	
		Head Temp:	
		Base Temp:	
		Power Temp:	
	Humidity Info	Head Humi:	
		Base Humi:	
	Fan Speed	Base Fan1:xxxx RPM	
		Base Fan2: xxxx RPM	
		Cool Fan1: xxxx RPM	
		Cool Fan2: xxxx RPM	
		Cool Fan3: xxxx RPM	
		Cool Fan4: xxxx RPM	
		Cool Fan5: xxxx RPM	
		Gobo Fan:xxxx RPM	
		CMY Fan:xxxx RPM	
		Head Fan1:xxxx RPM	
		Head Fan2:xxxx RPM	
		.....	
	Error. Info	Pan,Tilt.....	
	Model. Info	FLEXON L	
	Software Version	1U FXL V 2.0.0.B	
		2U FXL V 2.0.0.B	
3U FXL V 2.0.0.B			

# NXT<sup>®</sup>

NXT Group International Ltd.  
support@nxtlights.com  
nxtlights.com

## FLEXON L

### DMX Chart



## NXT IS NOW.

NXT LIGHTS | FLEXON L | DMX Chart











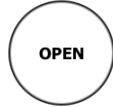

DMX Modes







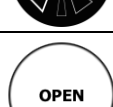
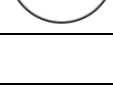

Standard Mode 46 Channel

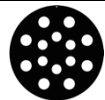
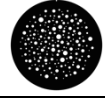

Extended Mode 60 Channel

STANDARD MODE 46 CH	EXTENDED MODE 60 CH	VALUES	FUNCTION
<b>MOVEMENT</b>			
1	1	000 - 255	<b>PAN Movement 8-bit:</b> Pan Movement
2	2	000 - 255	<b>PAN Fine 16-bit:</b> Fine control of Pan movement
3	3	000 - 255	<b>TILT Movement 8-bit:</b> Tilt Movement
4	4	000 - 255	<b>Tilt Fine 16-bit:</b> Fine control of Tilt movement
5	5	000 - 255	<b>Dummy – No control</b>
<b>DIMMER (INTENSITY)</b>			
6	6	000 - 255	<b>Dimmer 8-bit:</b> Intensity 0 to 100%
7	7	000 - 255	<b>Dimmer Fine 16-bit:</b> Intensity 0 to 100%
<b>SHUTTER, STROBE</b>			
8	8	000 - 031	Closed
		032 - 063	Open
		064 - 095	Strobe, Slow -> Fast
		096 - 127	Open
		128 - 159	Pulse effect, Slow -> Fast
		160 - 191	Open
		192 - 223	Random strobe, Slow -> Fast
		224 - 255	Open
<b>COLOR - CMY</b>			
9	9	000 - 255	<b>Cyan:</b> 0 to 100%
	10	000 - 255	<b>Cyan Fine:</b> 0 to 100%
10	11	000 - 255	<b>Magenta:</b> 0 to 100%
	12	000 - 255	<b>Magenta Fine:</b> 0 to 100%

11	13	000 - 255	<b>Yellow:</b>	
			0 to 100%	
	14	000 - 255	<b>Yellow Fine:</b> 0 to 100%	
<b>CTO</b>				
12	15	000 - 255	<b>CTO</b>	
			0 to 100%	
	16	000 - 255	<b>CTO Fine:</b> 0 to 100%	
<b>TINT</b>				
13	17	000 - 000	Uncorrected white step	
		001 - 127	Minus green -> Uncorrected white	
		128 - 128	Uncorrected white	DEFAULT
		129 - 255	Uncorrected white -> Plus green	
	18	000 - 255	<b>TINT Fine:</b> 0 to 100%	
<b>COLOR WHEEL</b>				
14	19	000 - 006	Open	
		007 - 030	Color 1 - Deep Red	
		031 - 054	Color 2 - Medium Blue	
		055 - 078	Color 3 - Deep Green	
		079 - 102	Color 4 - Amber	
		103 - 126	Color 5 - CTB	
		127 - 192	Open	
		193 - 223	CW, Fast -> Slow	
		224 - 224	Stop	
		225 - 255	CCW, Slow -> Fast	
15	20	000 - 255	<b>Color Wheel Fine</b> 0% to 100%	

ROTATING GOBO 1				
16	21	000 - 005	Beam Mode	
		006 - 020	Gobo 1 - Petal Spin	
		021 - 035	Gobo 2 - Disc	
		036 - 050	Gobo 3 - Double Disc	
		051 - 065	Gobo 4 - Particles	
		066 - 080	Gobo 5 - Abstract	
		081 - 095	Gobo 6 - Rims	
		096 - 110	Gobo 1 shake (slow-fast)	
		111 - 125	Gobo 2 shake (slow-fast)	
		126 - 140	Gobo 3 shake (slow-fast)	
		141 - 155	Gobo 4 shake (slow-fast)	
		156 - 170	Gobo 5 shake (slow-fast)	
		171 - 185	Gobo 6 shake (slow-fast)	
		186 - 192	Open	
		193 - 223	CW, Fast -> Slow	
		224 - 224	Stop	

		225 - 255	CCW, Slow -> Fast	
<b>ROTATING GOBO 1 INDEX</b>				
17	22	000 - 005	Rotation Off	
		006 - 128	Gobo Index 0° -> 540°	
		129 - 191	Gobo Rotation CW, Fast -> Slow	
		192 - 192	Stop	
		193 - 255	Gobo Rotation CCW, Slow -> Fast	
18	23	000 - 255	<b>Rotating Gobo Index Fine:</b> 0% to 100%	
<b>ROTATING GOBO 2</b>				
19	24	000 - 005	Open	
		006 - 020	Gobo 1 - Hexagons	
		021 - 035	Gobo 2 - Whirl Eye	
		036 - 050	Gobo 3 - Water	
		051 - 065	Gobo 4 - Leaf	
		066 - 080	Gobo 5 - Dots	
		081 - 095	Gobo 6 - Stars	
		096 - 110	Gobo 1 shake (slow-fast)	
		111 - 125	Gobo 2 shake (slow-fast)	
		126 - 140	Gobo 3 shake (slow-fast)	
		141 - 155	Gobo 4 shake (slow-fast)	

		156 - 170	Gobo 5 shake (slow-fast)	
		171 - 185	Gobo 6 shake (slow-fast)	
		186 - 192	Open	
		193 - 223	CW, Fast -> Slow	
		224 - 224	Stop	
		225 - 255	CCW, Slow -> Fast	
<b>ROTATING GOBO 2 INDEX</b>				
20	25	000 - 005	Rotation Off	
		006 - 128	Gobo Index 0° -> 540°	
		129 - 191	Gobo Rotation CW, Fast -> Slow	
		192 - 192	Stop	
		193 - 255	Gobo Rotation CCW, Slow -> Fast	
21	26	000 - 255	<b>Rotating Gobo Index Fine:</b> 0% to 100%	
<b>ZOOM</b>				
22	27	000 - 255	Narrow to wide	
23	28	000 - 255	<b>Zoom Fine:</b> Narrow to wide 16-bit	
<b>FOCUS</b>				
24	29	000 - 255	Far to near	
25	30	000 - 255	<b>Focus Fine:</b> Far to near 16-bit	

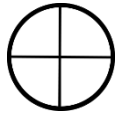
IRIS				
26	31	000 - 191	Open -> Close	
		192 - 207	Pulse up, slow -> fast	
		208 - 223	Pulse down, slow -> fast	
		224 - 239	Random effect, slow -> fast	
		240 - 255	Fast Up - Fast Down, slow -> fast	
PRISM WHEEL				
27	32	000 - 005	Open	
		006 - 130	6 Linear	
		131 - 255	4 Circular	
PRISM 1 INDEXING AND ROTATION				
28	33	000 - 005	Rotation Off	
		006 - 128	Prism1 Position 0 -> 540°	
		129 - 191	Prism1 Rotation CW, Fast -> Slow	
		192 - 192	Prism1 Rotation Stop	
		193 - 255	Prism1 Rotation CCW, Slow -> Fast	
29	34	000 - 255	<b>Prism 1 Indexing Fine:</b> 0% to 100%	
FROST 1 - LIGHT FROST				
30	35	000 - 255	Min to Max	
FROST 2 - HEAVY FROST				
31	36	000 - 255	Min to Max	

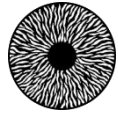
ANIMATION WHEEL				
32	37	000 - 005	Open	
		006 - 128	Animation Wheel Position 0 -> 540°	
		129 - 191	Animation Wheel Rotation CW, Fast -> Slow	
		192 - 192	Stop	
		193 - 255	Animation Wheel Rotation CCW, Slow -> Fast	
BLADES				
33	38	000 - 255	<b>Blade 1 A:</b>	
			0 to 100%	
	39	000 - 255	<b>Blade 1 A fine:</b>	
			0 to 100%	
34	40	000 - 255	<b>Blade 1 B:</b>	
			0 to 100%	
	41	000 - 255	<b>Blade 1 B fine:</b>	
			0 to 100%	
35	42	000 - 255	<b>Blade 2 A:</b>	
			0 to 100%	
	43	000 - 255	<b>Blade 2 A fine:</b>	
			0 to 100%	
36	44	000 - 255	<b>Blade 2 B:</b>	
			0 to 100%	
	45	000 - 255	<b>Blade 2 B fine:</b>	
			0 to 100%	
37	46	000 - 255	<b>Blade 3 A:</b>	
			0 to 100%	
	47	000 - 255	<b>Blade 3 A fine:</b>	
			0 to 100%	
38	48	000 - 255	<b>Blade 3 B:</b>	
			0 to 100%	
	49	000 - 255	<b>Blade 3 B fine:</b>	
			0 to 100%	
39	50	000 - 255	<b>Blade 4 A:</b>	
			0 to 100%	

	51	000 - 255	<b>Blade 4 A fine:</b>	
			0 to 100%	
40	52	000 - 255	<b>Blade 4 B:</b>	
			0 to 100%	
	53	000 - 255	<b>Blade 4 B fine:</b>	
			0 to 100%	
41	54	000 - 255	<b>Shape Rotation:</b>	
			-60° -> 60°	
	55	000 - 255	<b>Shape Rotation fine:</b>	
			Fine control of Shape Rotation	
<b>FRAME MACRO</b>				
42	56	000 - 004	Frame Macro default	
		005 - 009	Macro 1	
		010 - 014	Macro 2	
		015 - 019	Macro 3	
		020 - 024	Macro 4	
		025 - 029	Macro 5	
		030 - 034	Macro 6	
		035 - 039	Macro 7	
		040 - 044	Macro 8	
		045 - 049	Macro 9	
		050 - 054	Macro 10	
		055 - 059	Macro 11	
		060 - 064	Macro 12	
		065 - 069	Macro 13	
		070 - 074	Macro 14	
		075 - 079	Macro 15	
		080 - 084	Macro 16	
		085 - 089	Macro 17	
		090 - 094	Macro 18	
		095 - 099	Macro 19	
		100 - 104	Macro 20	
		105 - 109	Macro 21	
		110 - 114	Macro 22	
		115 - 119	Macro 23	
		120 - 124	Macro 24	
		125 - 129	Macro 25	

		130 - 134	Macro 26	
		135 - 139	Macro 27	
		140 - 144	Macro 28	
		145 - 149	Macro 29	
		150 - 154	Macro 30	
		155 - 159	Macro 31	
		160 - 164	Macro 32	
		165 - 169	Macro 33	
		170 - 174	Macro 34	
		175 - 179	Macro 35	
		180 - 184	Macro 36	
		185 - 189	Macro 37	
		190 - 194	Macro 38	
		195 - 199	Macro 39	
		200 - 204	Macro 40	
43	57	000 - 255	<b>Frame Macro Effects Speed:</b> 0% to 100%	
<b>PAN/TILT SPEED</b>				
44	58	000 - 255	Max to Min speed	
<b>LED ENGINE CONTROL</b>				
45	59	000 - 127	High Power LED Engine	Default
		128 - 255	High CRI LED Engine	
<b>DEVICE SETTINGS</b>				
46	60	000 - 005	No function	
		006 - 010	On Display Backlight (Hold 3s)	
		011 - 015	Off Display Backlight (Hold 3s)	
		016 - 025	No function	
		026 - 030	FollowSpot Mode ON (Hold 3s)	
		031 - 035	FollowSpot P/T ONLY (Hold 3s)	
		036 - 040	FollowSpot Mode OFF (Hold 3s)	
		041 - 050	No function	
		051 - 055	Factory Default (Hold 3s)	Dimmer 0, Shutter 0, hold 3s
		056 - 060	No function	
		061 - 065	Fan Auto (Hold 3s)	
		066 - 070	Fan High (Hold 3s)	
		071 - 075	Fan Silent (Hold 3s)	

076 - 080	Fan Ultra Silent (Hold 3s)	
081 - 085	Fan Studio Mode (Hold 3s)	
086 - 090	No function	
091 - 095	Linear Dimmer Curve (hold 3s)	
096 - 100	Square Law Dimmer Curve (hold 3s)	
101 - 105	Inv-Square Dimmer Curve (hold 3s)	
106 - 110	S - Dimmer Curve (hold 3s)	
111 - 120	No function	
121 - 123	Led Freq. 1200 Hz (Hold 3s)	
124 - 126	Led Freq. 3600 Hz (Hold 3s)	
127 - 129	Led Freq. 5000 Hz (Hold 3s)	
130 - 132	Led Freq. 10.000 Hz (Hold 3s)	
133 - 135	Led Freq. 15.000 Hz (Hold 3s)	
136 - 138	Led Freq. 20.000 Hz (Hold 3s)	
139 - 141	Led Freq. 25.000 Hz (Hold 3s)	
142 - 150	No function	
151 - 155	Reset Pan/Tilt (Hold 3s)	
156 - 160	Reset only Head (Hold 3s)	
161 - 165	Reset All Functions (Hold 3s)	
166 - 170	Dim Mode Standard (Hold 3s)	
171 - 173	Dim Mode Stage (Hold 3s)	
174 - 176	Dim Mode TV (Hold 3s)	
177 - 179	Dim Mode Architectural (Hold 3s)	
180 - 182	Dim Mode Theatre (Hold 3s)	
183 - 220	No function	
221 - 225	Gobo CTB auto ON (Hold 3s)	
226 - 230	Gobo CTB auto OFF (Hold 3s)	
231 - 255	No function	

**NXT.**<sup>®</sup>

**NXT IS NOW.**