

Olanda



Olanda 102

acciaio / stainless steel



102/241 BB

Maniglia con rosetta mini.
Bocchetta foro chiave.
Handle with minimal rose.
Escutcheon with key hole.

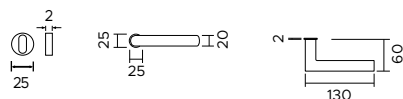
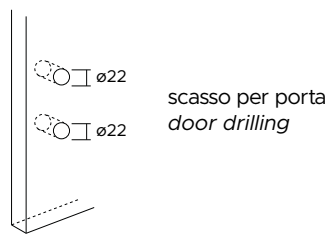

102/241 PZ

Maniglia con rosetta mini.
Bocchetta foro cilindro.
Handle with minimal rose.
Escutcheon with cylinder hole.

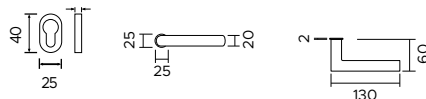
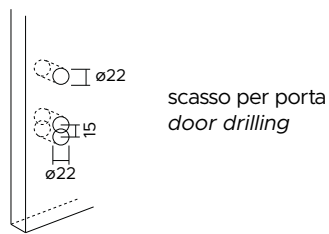

102/241 WC310

Maniglia con rosetta mini.
Bocchetta foro WC.
Handle with minimal rose.
Escutcheon with WC hole.

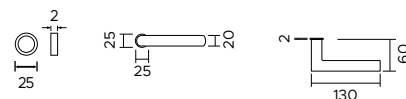
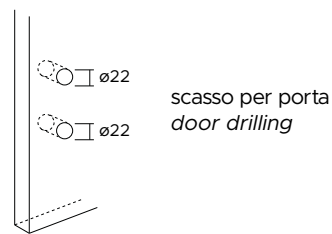

F61

acciaio lucido
polished steel



F60

acciaio satinato
satin steel



F020

effetto ottone satinato opaco
opaque satin brass effect



FNO

nero opaco
opaque black



FBO

bianco opaco
opaque white



Olanda 102

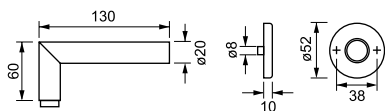

sottorosetta
in plastica

PVC under
constructions

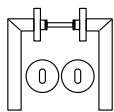

102.236.B

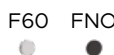

foro chiave
key hole

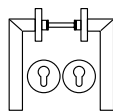

102.236.Z

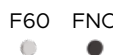

foro cilindro
cylinder hole

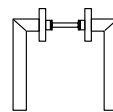

102.236



senza bocchette
without escutcheons

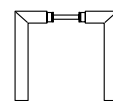

102



bilancino
pair of handles

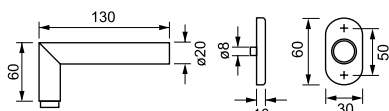

sottorosetta
in plastica

PVC under
constructions

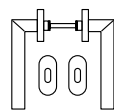

102.277.B



foro chiave
key hole

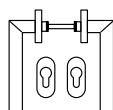

102.277.Z

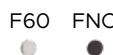

foro cilindro
cylinder hole

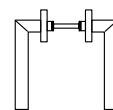

102.277



senza bocchette
without escutcheons

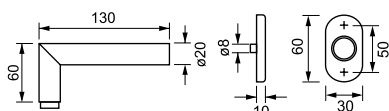

sottorosetta
in metallo

metal under
constructions

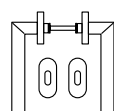

102.277.CMB

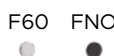

foro chiave
key hole

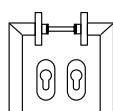

102.277.CMZ

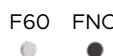

foro cilindro
cylinder hole

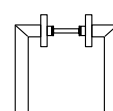

102.277.CM



senza bocchette
without escutcheons

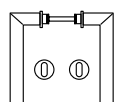
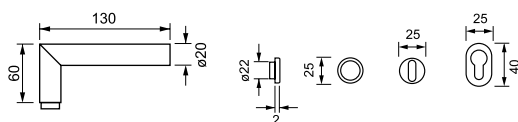

102.241.B

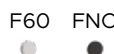

foro chiave
key hole

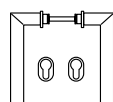

102.241.Z

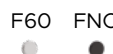

foro cilindro
cylinder hole

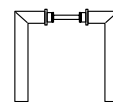

102.241



senza bocchette
without escutcheons

finitura a richiesta / finishes on request

F61

inox lucido
polished s. steel

F41

bianco opaco ral 9010
opaque white ral 9010

FBO

bianco opaco ral 9016
opaque white ral 9016



distanza foro chiave/
cilindro/wc da specificare
key/cylinder/wc hole
distance to be specified

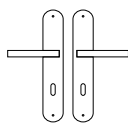
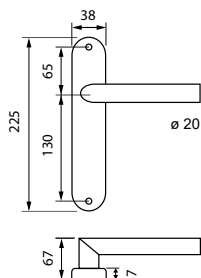

102.202L.B

F60 FNO

foro chiave
key hole

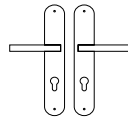

102.202L.Z

F60 FNO

foro cilindro
cylinder hole

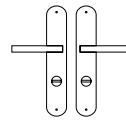

102.202L.W

F60 FNO

nottolino wc
privacy knob

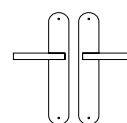

102.202L

F60 FNO

bilancino
pair of handles

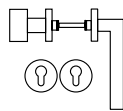
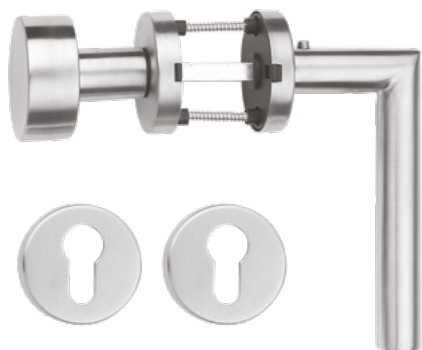

PZW.102.236.327

F60 FNO

foro cilindro
cylinder hole

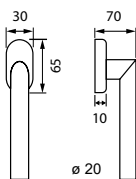
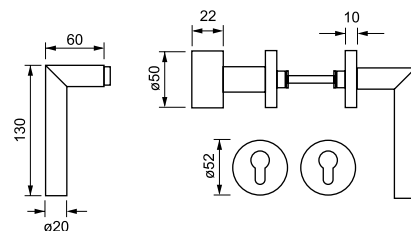
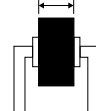

102.DK

F60 FNO

DK
window handle

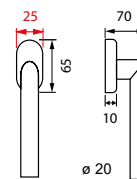

102.DK25

F60 FNO

DK stretto
narrow window handle

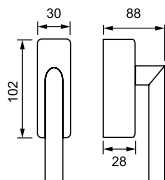

102.DKS

F60 FNO

DK di sicurezza
safety window handle

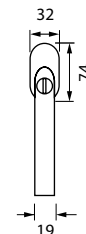
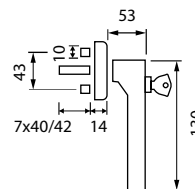

102 DKL

F60 FNO

DK antieffrazione
c/chave e cilindro frontale
burglary resistance DK with
key and front cylinder

Olanda 102 antincendio / fire rated



FERRO - SPINDLE $\nabla 9$

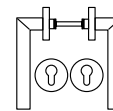
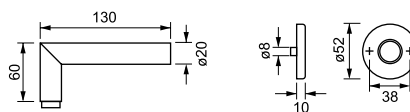

102TF.236CM.PZ

F60 FNO

foro cilindro
cylinder hole



sottorosetta
in metallo

metal under
constructions



FERRO - SPINDLE $\nabla 9$

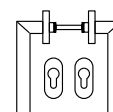
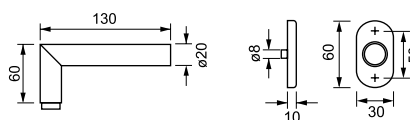

102TF.277CM.PZ

F60 FNO

foro cilindro
cylinder hole



sottorosetta
in metallo

metal under
constructions

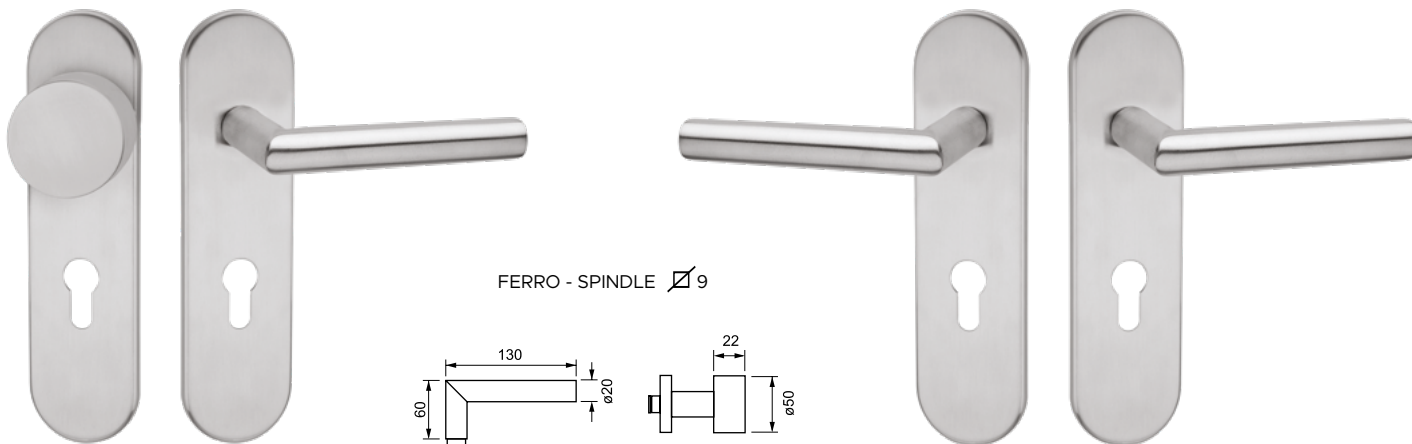

FERRO - SPINDLE $\nabla 9$

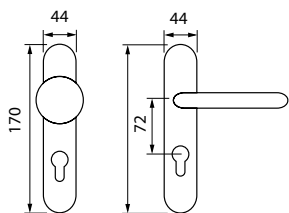
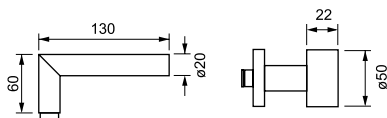

PZWL.102TF.202S.327.72 SX

PZWR.102TF.202S.327.72 DX

F60 FNO

foro cilindro
cylinder hole

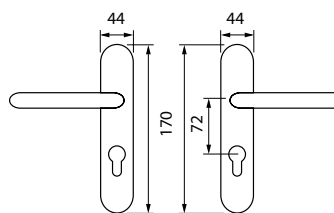

102TF.202S.Z72

F60 FNO

foro cilindro
cylinder hole

Olanda 102 classe 3 / class 3



FERRO - SPINDLE $\nabla 8$

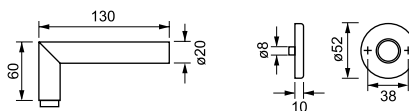

CLASSE
3

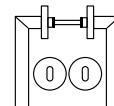

102236CMB60.CL3

F60 FNO



foro chiave
key hole



sottorosetta
in metallo

metal under
constructions



FERRO - SPINDLE $\nabla 8$

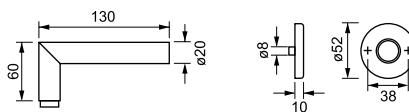

CLASSE
3

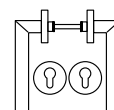

102236CMZ60.CL3

F60 FNO



foro cilindro
cylinder hole



sottorosetta
in metallo

metal under
constructions



FERRO - SPINDLE $\nabla 8$

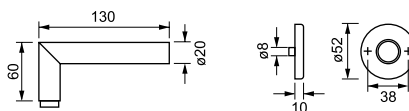

CLASSE
3

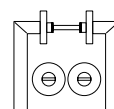

102236CMW31260.CL3

F60 FNO



nottolini WC
privacy knob



sottorosetta
in metallo

metal under
constructions

Olanda 102 pubblica / public

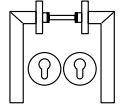
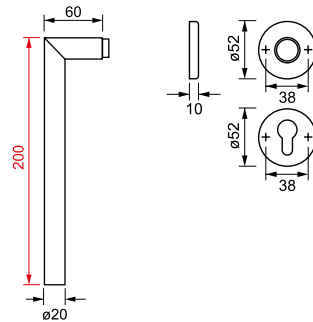

102.236.Z.200

F60 FNO



foro cilindro
cylinder hole

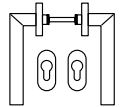
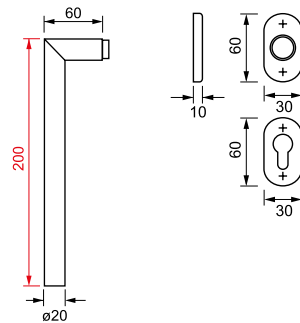
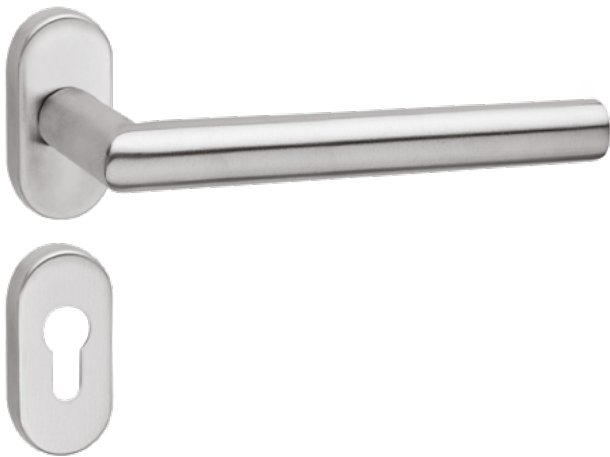

102.277.Z.200

F60 FNO



foro cilindro
cylinder hole

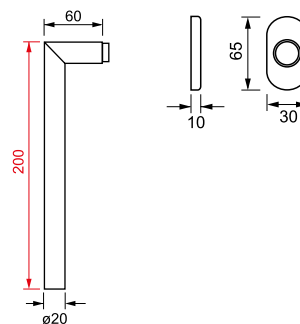

102.DK.200

F60 FNO



DK
window

Modello non adatto per porte scorrevoli - Lunghezza impugnatura 200 mm / Model not suitable for sliding doors - Lever handle length 200 mm

finitura a richiesta / finishes on request

F61

inox lucido
polished s. steel

F41

bianco opaco ral 9010
opaque white ral 9010

FBO

bianco opaco ral 9016
opaque white ral 9016

Olanda 102 ridotta / reduced

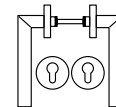
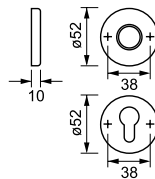
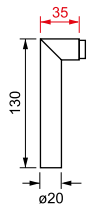

102.236.Z.RI

F60 FNO



foro cilindro
cylinder hole

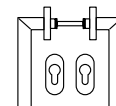
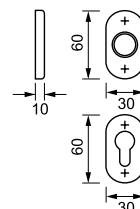
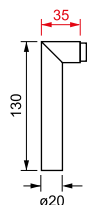

102.277.Z.RI

F60 FNO



foro cilindro
cylinder hole

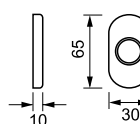
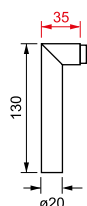

102.DK.RI

F60 FNO



DK
window

finitura a richiesta / finishes on request

F61

inox lucido
polished s. steel

F41

bianco opaco ral 9010
opaque white ral 9010

FBO

bianco opaco ral 9016
opaque white ral 9016

Olanda 102 disassata / offset

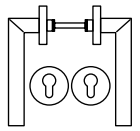
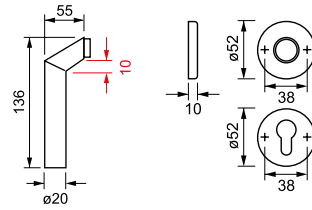

102IN.236.Z

F60 FNO



foro cilindro
cylinder hole

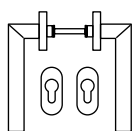
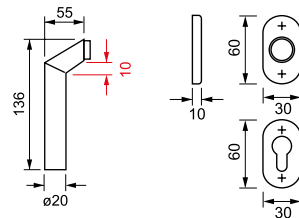

102IN.277.Z

F60 FNO



foro cilindro
cylinder hole

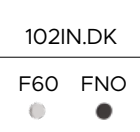
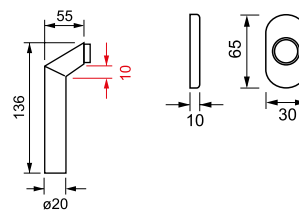

102IN.DK

F60 FNO



DK
window

finitura a richiesta / finishes on request

F61

inox lucido
polished s. steel

F41

bianco opaco ral 9010
opaque white ral 9010

FBO

bianco opaco ral 9016
opaque white ral 9016

Olanda 102.AL



102.AL01

F60 FNO



senza foro
without hole



102.AL04

F60 FNO



foro cilindro
cylinder hole



102.AL02

F60 FNO



senza foro con nicchia
without hole and flush niche



102.AL05

F60 FNO



foro cilindro con nicchia
cylinder hole and flush niche



102.AL03

F60 FNO



coppia senza foro
pair without hole



102.AL06

F60 FNO



coppia foro cilindro
pair with cylinder hole

fresatura per nicchia
milling for flush handle

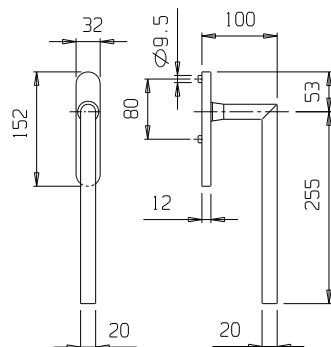
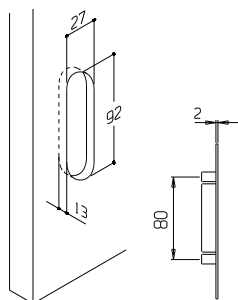

finitura a richiesta / finishes on request

F61

inox lucido
polished s. steel

F41

bianco opaco ral 9010
opaque white ral 9010

FBO

bianco opaco ral 9016
opaque white ral 9016

Olanda 102.AL.RI reduced



102.AL01.RI

F60 FNO



senza foro
without hole



102.AL04.RI

F60 FNO



foro cilindro
cylinder hole



102.AL02.RI

F60 FNO



senza foro con nicchia
without hole and flush niche



102.AL05.RI

F60 FNO



foro cilindro con nicchia
cylinder hole and flush niche



102.AL03.RI

F60 FNO



coppia senza foro
pair without hole



102.AL06.RI

F60 FNO



coppia foro cilindro
pair with cylinder hole

fresatura per nicchia
milling for flush handle

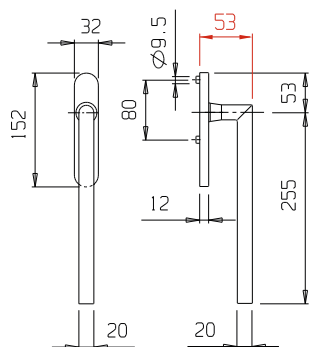
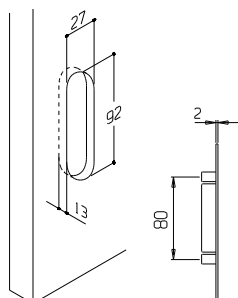

finitura a richiesta / finishes on request

F61

inox lucido
polished s. steel

F41

bianco opaco ral 9010
opaque white ral 9010

FBO

bianco opaco ral 9016
opaque white ral 9016

Aisi 316

Grade 316



Olanda 102

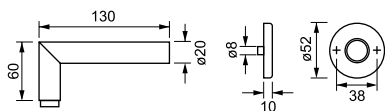

sottorosetta
in plastica

PVC under
constructions

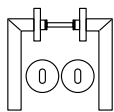

102.236.B

F62

foro chiave
key hole

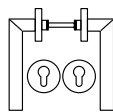

102.236.Z

F62

foro cilindro
cylinder hole

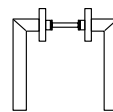

102.236

F62

senza bocchette
without escutcheons

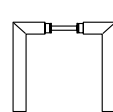

102

F62

bilancino
pair of handles

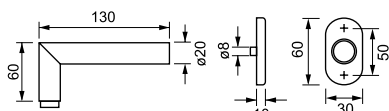

sottorosetta
in plastica

PVC under
constructions



102.277.B

F62

foro chiave
key hole



102.277.Z

F62

foro cilindro
cylinder hole



102.277

F62

senza bocchette
without escutcheons

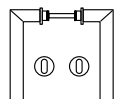
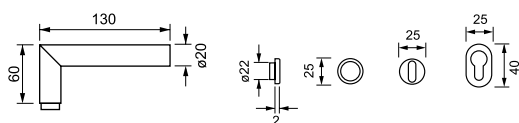

102.241.B

F62

foro chiave
key hole

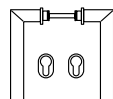

102.241.Z

F62

foro cilindro
cylinder hole

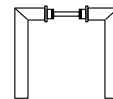

102.241

F62

senza bocchette
without escutcheons

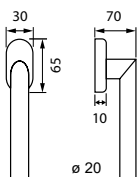

102.DK

F62

DK
window
handle

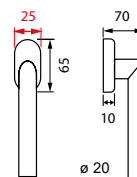

102.DK25

F62

DK stretto
safety window
handle

finitura a richiesta / finishes on request

F61

inox lucido
polished s. steel

Olanda 102.AL



102.AL01

F62

senza foro
without hole



102.AL04

F62

foro cilindro
cylinder hole



102.AL02

F62

senza foro con nicchia
without hole and flush niche



102.AL05

F62

foro cilindro con nicchia
cylinder hole and flush niche



102.AL03

F62

coppia senza foro
pair without hole



102.AL06

F62

coppia foro cilindro
pair with cylinder hole

fresatura per nicchia
milling for flush handle

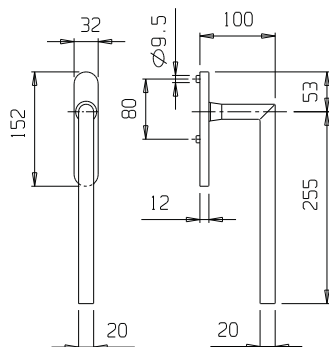
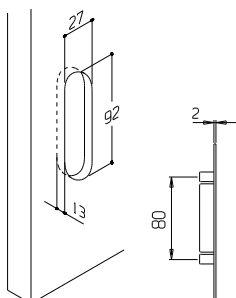

finitura a richiesta / finishes on request

F61

inox lucido
polished s. steel

Olanda 102.AL.RI reduced



102.AL01.RI

F62

senza foro
without hole



102.AL04.RI

F62

foro cilindro
cylinder hole



102.AL02.RI

F62

senza foro
con nicchia
without hole
and flush niche



102.AL05.RI

F62

foro cilindro
con nicchia
cylinder hole
and flush niche



102.AL03.RI

F62

coppia
senza foro
pair
without hole



102.AL06.RI

F62

coppia
foro cilindro
pair
with
cylinder hole

fresatura per nicchia
milling for flush handle

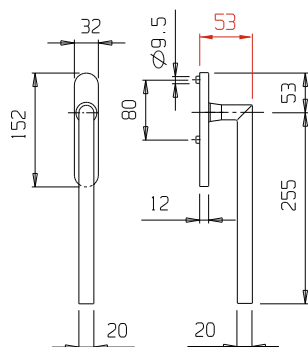
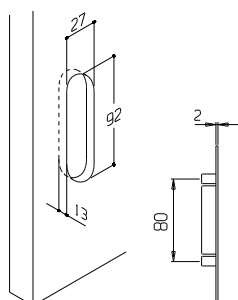

finitura a richiesta / finishes on request

F61

inox lucido
polished s. steel