

# ST1202-D



Type:  
 Steengrijper  
 Stone grab  
 Steingreifer  
 Grappins à pierres



geopend/opened/  
geöffnet/ouverte

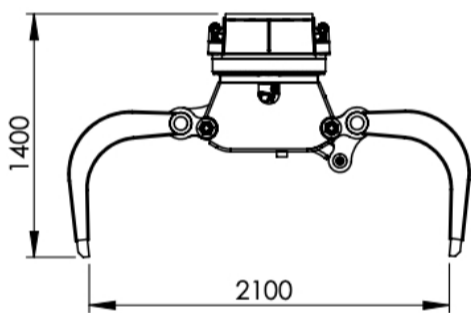

gesloten/closed/  
geschlossen/fermé

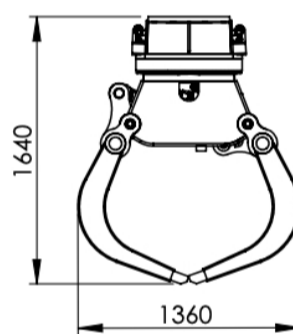

Ophanging/Suspension/  
Suspension/Suspension

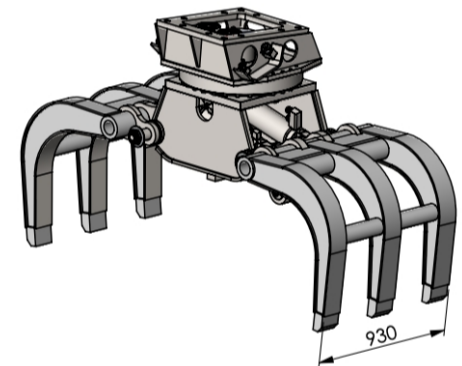

## TECHNICAL SPECIFICATIONS

Nederlands

English

Deutsch

Français

Nederlands	English	Deutsch	Français		
Klasse graafmachine	Class excavator	Machine klasse	Classe de excavatrice	t	17-28
Gewicht	Weight	Gewicht	Poids	Kg	1500
Werkdruk max.	Op. pressure max	Betät. druck max	Pression maximale	bar	350
Werkdruk rotatie min.	Op. pressure rotation min	Betät. druck rotation min	Pression rotation min	bar	210
Werkdruk rotatie max	Op. pressure rotation max	Betät. druck rotation max	Pression rotation max	bar	190
Olieflow max	Oil flow max	Öfluss max	Débit d'huile max	l/min	160
Olieflow rotatie max	Oil flow rotation max	Öfluss rotation max	Débit d'huile rotation max	l/min	35
Inhoud	Capacity	Inhalt	Contenance	ltr	800
Sluitkracht	Closing force	Schliesskraft	Force de fermeture	kN	68