

KEEPOR CEILING CONNECTION is a new solution developed for BROKIS lighting collections that eliminates the need for a traditional ceiling canopy and simplifies installation into plasterboard suspended ceilings. It lends ceiling installations a clean, minimalist appearance while introducing a new level of flexibility in the creation of original lighting compositions.

BROKIS offers the KEEPOR system in four variants, with the appropriate solution depending on the specific lighting collection and method of hanging. KEEPOR is ideal for plasterboard suspended ceilings, where the system is subsequently filled and surface-finished. As a result, the thickness of the material is not a determining factor.

The components are manufactured from stainless steel and duralumin. The visible detail – the cap – is available in black or white.

As part of its commitment to meeting customer needs, BROKIS has introduced the KEEPOR CEILING CONNECTION to provide a simpler and more technologically advanced method for installing BROKIS lights into plasterboard suspended ceilings. The minimalist appearance and clean execution of the KEEPOR system further emphasise the distinctive character of BROKIS interior lighting.

4 versions (cable, coaxial cable, cable + wire and cable + solo wire)
1 installation tool

Version for cable

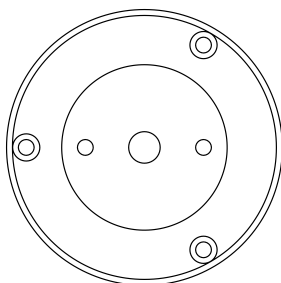
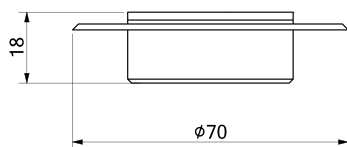

Version for coaxial cable

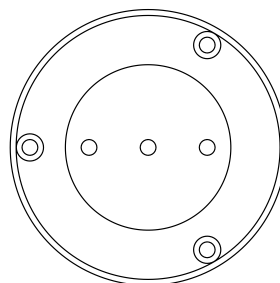
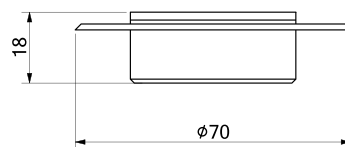

Version for cable + wire

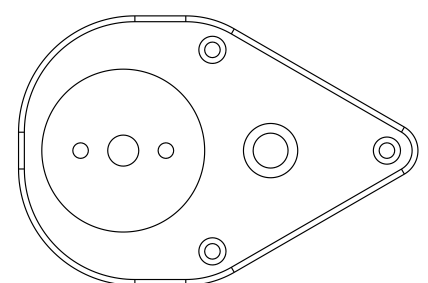
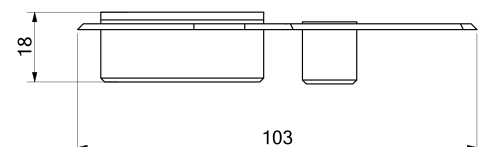

Version for cable + solo wire

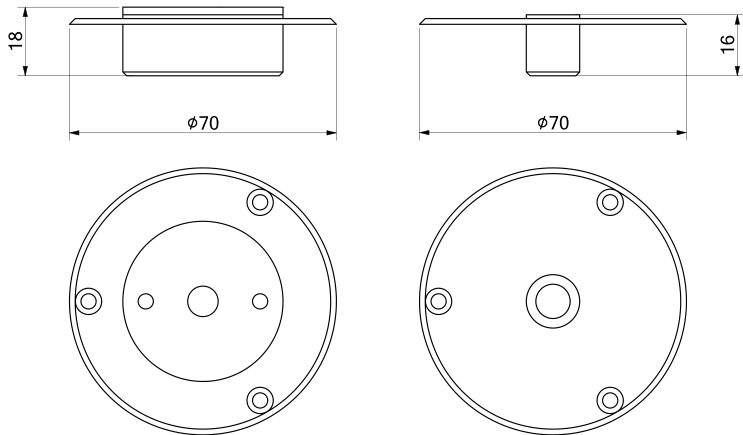

Used materials and finishes/colors

Body + lid – sandblasted stainless steel

Lid powder-coated in the following shades: black (RAL 9005) + white textured finish (RAL 9003).

Component body left raw, sandblasted for improved sealant adhesion.

Version for cable

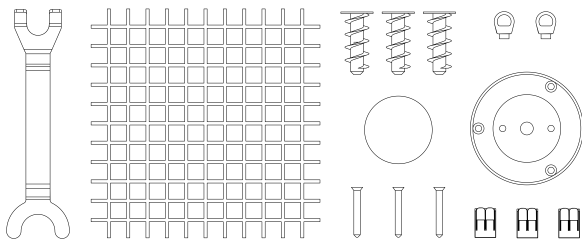

Version for coaxial cable

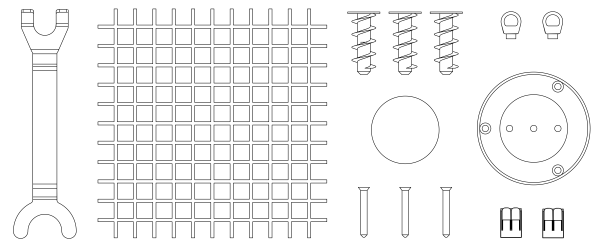

Version for cable + wire

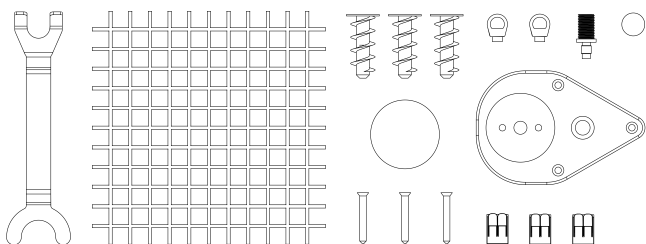

Version for cable + wire

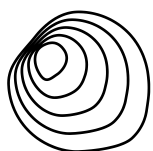
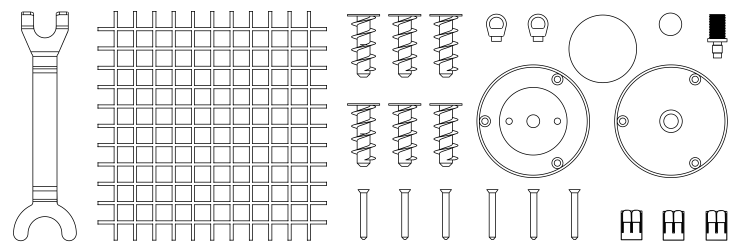

BROKIS®

BROKIS s.r.o. Sídliště
Janštejn 39 588 52
Horní Dubenky Czech
Republic +420 567 211
517 info@brokis.cz
brokis.com

Registrováno:
Městský soud v Praze
oddíl C značka 42174
IČ: 64940799
DIČ: CZ64940799



KEEP PORT INSTALLATION