

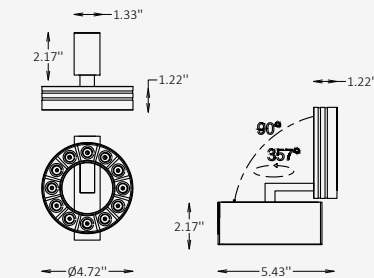

GENERAL INFORMATION

The A-LOOP POINT is a compact circular lighting module designed for the MODARI A-Track Core magnetic system, delivering clean, focused illumination within a refined geometric form. Its aluminum body, flexible dimming options, and extensive finish palette allow it to integrate seamlessly into both functional and decorative lighting layouts. Engineered for versatility, it can be used as an accent element or combined in multiples to create dynamic compositions.

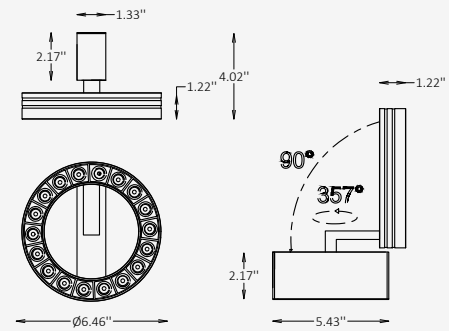

MODULE SPECIFICATIONS

Material	Aluminum
Diameter	4.72" / 6.46"
Height	1.22"
Input Voltage	DC 24V
Light Source Type	LED
Power	12W / 18W
CCT	2700K / 3000K / 4000K
CRI	80 / 90
Beam Angle	24° / 34° / 48°
Dimming	Non-Dim / 0-10V / 1-10V / DALI / TRIAC
IP Rating	IP 20
Warranty	5 years
Finishes	30 RAL finishes 8 wood-effect finishes 2 metallic finishes Custom on request*

OTHER VERSIONS AVAILABLE

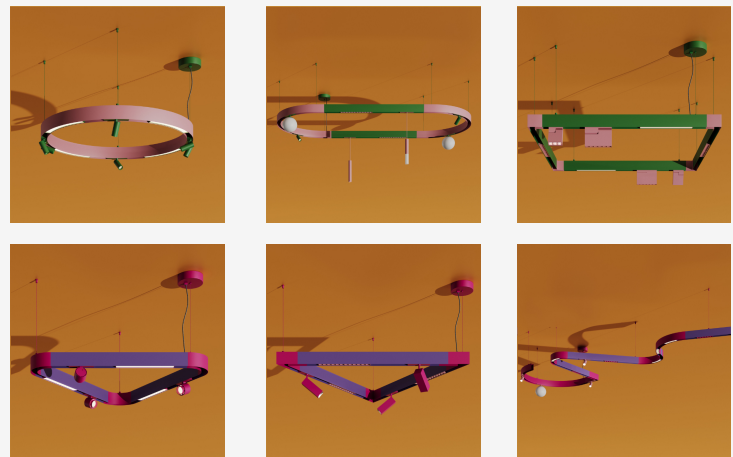

CERTIFICATION



A-Loop Point Module Ordering Information

Select one item from each category below. If your desired option is unavailable, please contact our team for support or custom solutions.

Code	Voltage	Diameter / Height / Wattage / Lumens	CCT
<input checked="" type="checkbox"/> LPT A-Loop Point Module	<input type="checkbox"/> D24 DC 24V	<input type="checkbox"/> 4 4.72" / 1.22" / 12 W / 950 lm	<input type="checkbox"/> 27 2700K
	<input type="checkbox"/> Cus Custom on request	<input type="checkbox"/> 6 6.46" / 1.22" / 18 W / 1562 lm	<input type="checkbox"/> 30 3000K
			<input type="checkbox"/> 40 4000K
			<input type="checkbox"/> Cus Custom on request
Beam Angle	CRI	Dimming	Finish Option
<input type="checkbox"/> B20 20°	<input type="checkbox"/> CR8 80	<input type="checkbox"/> NN Non-Dimmable	<input type="checkbox"/> ST Standard
<input type="checkbox"/> B34 34°	<input type="checkbox"/> CR9 90	<input type="checkbox"/> DM0 0-10V	<input type="checkbox"/> WE Wood effect
<input type="checkbox"/> B48 48°		<input type="checkbox"/> DM1 1-10V	<input type="checkbox"/> MC Metallic
		<input type="checkbox"/> DL DALI	<input type="checkbox"/> Cus Custom on request
		<input type="checkbox"/> TR TRIAC	

A-Loop Point Module Finishes

Standard finishes

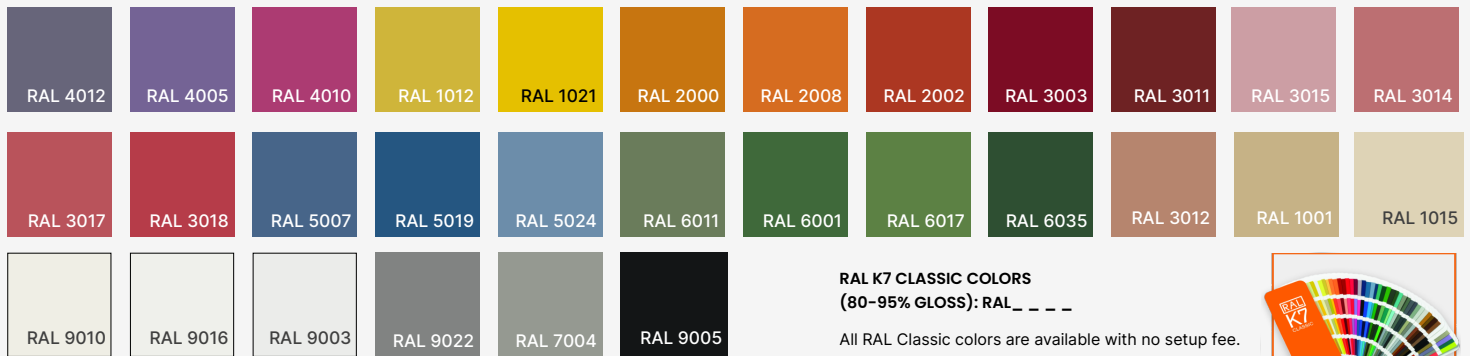

Wood-effect finishes



Metallic finishes

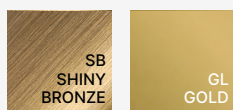

Photometric Data

A-Loop Point 4 / 20°

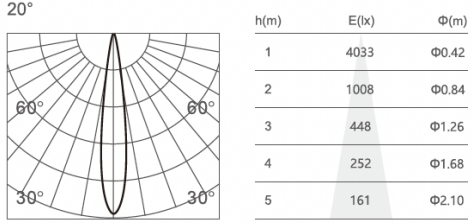

A-Loop Point 4 / 34°

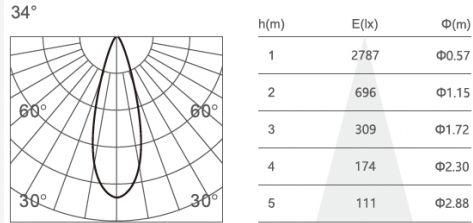

A-Loop Point 4 / 48°

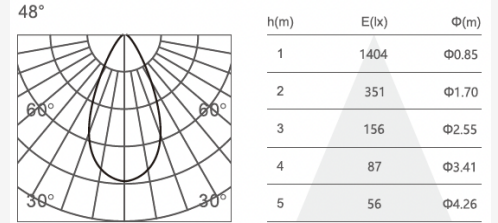

A-Loop Point 6 / 20°

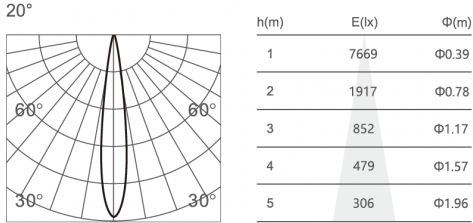

A-Loop Point 6 / 34°

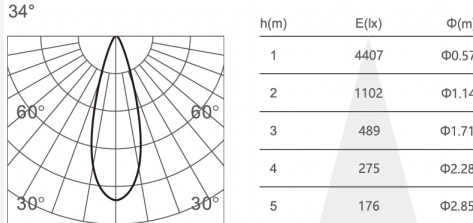

A-Loop Point 6 / 48°

