



GENERAL INFORMATION

The A-CYL is a cylindrical lighting module for the MODARI A-Track Core magnetic system, providing clean, focused illumination through its compact aluminum body. Its rounded profile softens the geometric composition while maintaining strong optical performance and visual comfort. With multiple beam options, dimming protocols, and finish choices, A-CYL integrates easily into both functional and decorative lighting arrangements.

MODULE SPECIFICATIONS

Material	Aluminum
Diameter	1.77" / 2.17" / 2.56"
Length	2.60" / 3.54" / 3.70"
Height	2.32" / 2.71" / 3.11"
Input Voltage	DC 24V
Light Source Type	LED
Power	8W / 12W / 16W
CCT	2700K / 3000K / 4000K
Beam Angle	24°
CRI	80 / 90
Dimming	Non-Dim / 0-10V / 1-10V / DALI / TRIAC
IP Rating	IP 20
Warranty	5 years
Finishes	30 RAL finishes 8 wood-effect finishes 2 metallic finishes Custom on request*

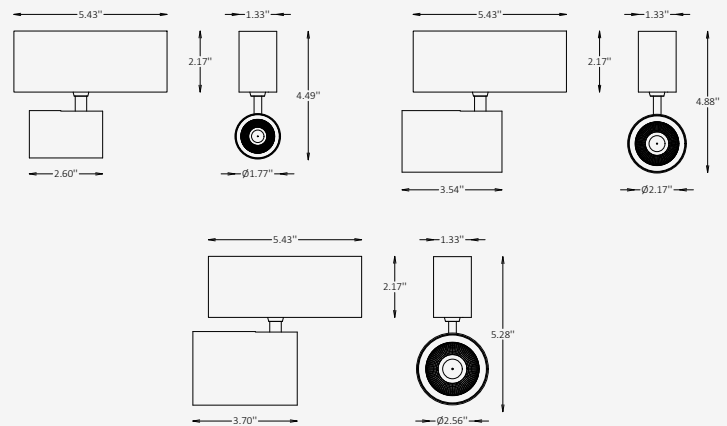

OTHER VERSIONS AVAILABLE

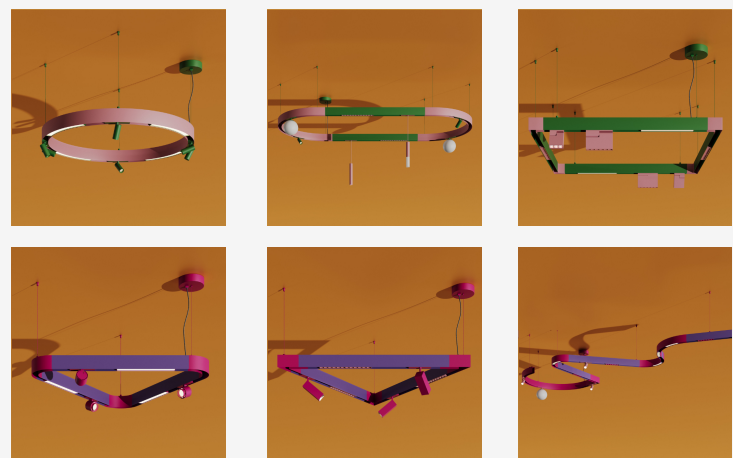

CERTIFICATION



A-Cyl Module Ordering Information

Select one item from each category below. If your desired option is unavailable, please contact our team for support or custom solutions.

Code	Voltage	Diameter / Length / Height / Wattage / Lumens	CCT
<input checked="" type="checkbox"/> CL A-Cyl Module	<input type="checkbox"/> D24 DC 24V	<input type="checkbox"/> 1 1.77" / 2.32" / 2.6" / 8 W / 600 lm	<input type="checkbox"/> 27 2700K
	<input type="checkbox"/> Cus Custom on request	<input type="checkbox"/> 2 2.17" / 2.71" / 3.54" / 12 W / 1005 lm	<input type="checkbox"/> 30 3000K
		<input type="checkbox"/> 3 2.56" / 3.11" / 3.7" / 16 W / 1333 lm	<input type="checkbox"/> 40 4000K
			<input type="checkbox"/> Cus Custom on request
Beam Angle	CRI	Dimming	Finish Option
<input checked="" type="checkbox"/> B24 24°	<input type="checkbox"/> CR8 80	<input type="checkbox"/> NN Non-Dimmable	<input type="checkbox"/> ST Standard
	<input type="checkbox"/> CR9 90	<input type="checkbox"/> DM0 0-10V	<input type="checkbox"/> WE Wood effect
		<input type="checkbox"/> DM1 1-10V	<input type="checkbox"/> MC Metallic
		<input type="checkbox"/> DL DALI	<input type="checkbox"/> Cus Custom on request
		<input type="checkbox"/> TR TRIAC	

A-Cyl Module Finishes

Standard finishes

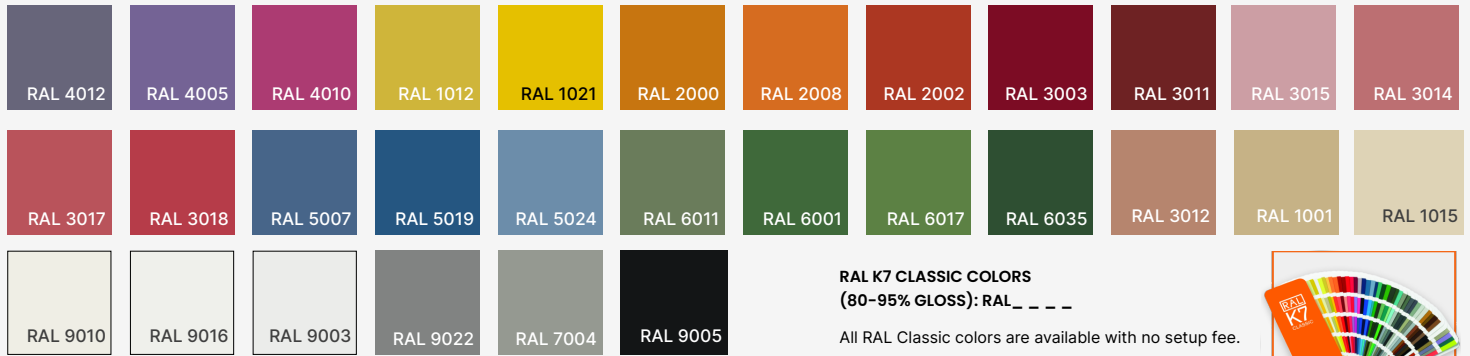

RAL K7 CLASSIC COLORS (80-95% GLOSS): RAL_ _ _ _

All RAL Classic colors are available with no setup fee.

On your specification submittal, choose your RAL color by entering the 4-digit RAL code (e.g., RAL 3003).



Wood-effect finishes



WO WHITE OAK OA OAK HO HONEY OAK MP MAPLE WT WALNUT MG MAHOGANY DO DARK OAK ES ESPRESSO

Metallic finishes

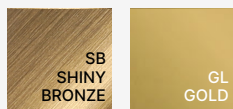

SB SHINY BRONZE GL GOLD

Photometric Data

A-Cyl 1 / 24°

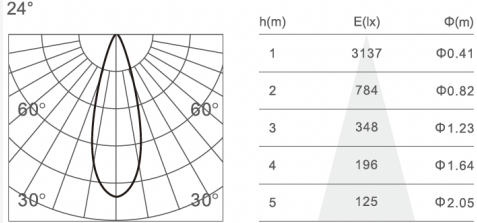

A-Cyl 2 / 24°

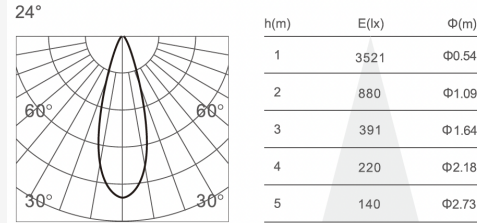

A-Cyl 3 / 24°

