

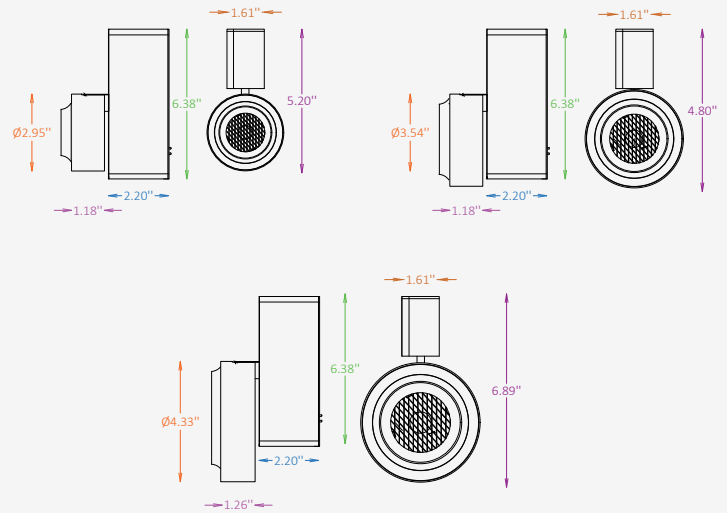

GENERAL INFORMATION

A-PIX SHIFT is a compact accent module for the MODARI magnetic track system, designed to provide focused illumination in a clean architectural form. Its minimal profile works with both curved and linear track layouts, making it ideal for highlighting details, displays, and focal points. Designed for residential, hospitality, retail, gallery, and commercial interiors, the module can be easily repositioned along the magnetic track. A-PIX SHIFT combines precise accent lighting, compact proportions, and seamless MODARI system integration.



MODULE SPECIFICATIONS

Material	Aluminum
Diameter	2.95" / 3.54" / 4.33"
Height	1.18" / 1.26"
Input Voltage	DC 24V
Light Source Type	LED
Power	10W / 15W / 20W
CCT	2700K / 3000K / 3500K / 4000K
CRI	80 / 90
Beam Angle	36°
Dimming	Non-Dim / 0-10V / 1-10V / DALI / TRIAC
IP Rating	IP 20
Warranty	5 years
Finishes	30 RAL finishes 8 wood-effect finishes 2 metallic finishes Custom on request*

OTHER VERSIONS AVAILABLE

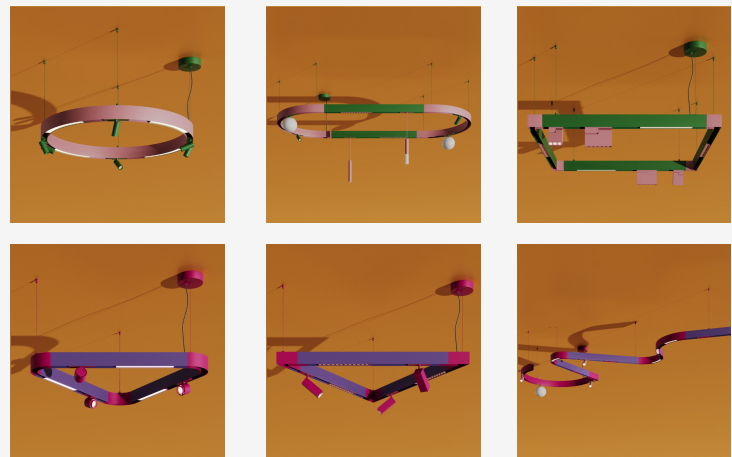

CERTIFICATION



A-Pix Shift Module Ordering Information

Select one item from each category below. If your desired option is unavailable, please contact our team for support or custom solutions.

Code	Voltage	Diameter / Wattage / Lumens	CCT
<input checked="" type="checkbox"/> PIX-SF A-Pix Shift Module	<input type="checkbox"/> D24 DC 24V	<input type="checkbox"/> 2 2.95" / 10W / 790 lm	<input type="checkbox"/> 27 2700K
	<input type="checkbox"/> Cus Custom on request	<input type="checkbox"/> 3 3.54" / 15W / 1072 lm	<input type="checkbox"/> 30 3000K
		<input type="checkbox"/> 4 4.33" / 20W / 1430 lm	<input type="checkbox"/> 35 3500K
			<input type="checkbox"/> 40 4000K
			<input type="checkbox"/> Cus Custom on request
Beam Angle	CRI	Dimming	Finish Option
<input checked="" type="checkbox"/> B36 36°	<input type="checkbox"/> CR8 80	<input type="checkbox"/> NN Non-Dimmable	<input type="checkbox"/> ST Standard
	<input type="checkbox"/> CR9 90	<input type="checkbox"/> DM0 0-10V	<input type="checkbox"/> WE Wood effect
		<input type="checkbox"/> DM1 1-10V	<input type="checkbox"/> MC Metallic
		<input type="checkbox"/> DL DALI	<input type="checkbox"/> Cus Custom on request
		<input type="checkbox"/> TR TRIAC	

A-Pix Shift Module Finishes

Standard finishes

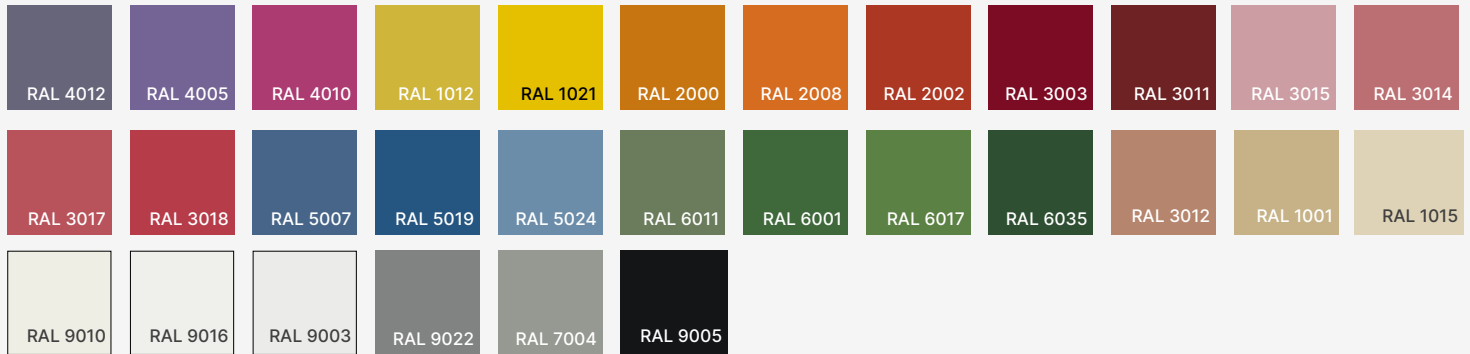

Wood-effect finishes



Metallic finishes

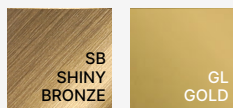

RAL K7 CLASSIC COLORS

(80-95% GLOSS): RAL_ _ _ _

All RAL Classic colors are available with no setup fee.

On your specification submittal, choose your RAL color by entering the 4-digit RAL code (e.g., RAL 3003).

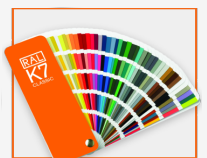

Project

Notes

Photometric Data

A-Pix Shift 2 / 36°

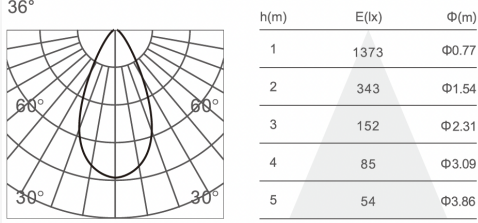

A-Pix Shift 3 / 36°

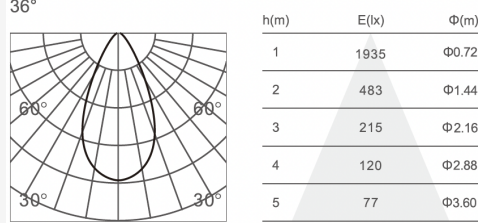

A-Pix Shift 4 / 36°

