

Street Communication

Active Game LED Floor



Specification :

Products Name	Active Game Led Floor
Model No.	SF-LDG30
Power	7W
Material	Optional -ABS+10mm Tempered glass OR Die-Casting housing+10mm Tempered glass (surface with black border)
Light source	5050 high brightness LED
Size	L300*W300*H75mm(ABS) /H85mm(Die-casting)
Color	RGB color changing
Input voltage	DC24V
Protocol	Independent development
Function	Interactive
NetWeight kg	3kg (ABS)/3.1KG(Die-casting)
Control Mode	PC Control
Waterproof Rate	IP 65 or IP67 optional
Loading capacity	500kg/pc

Street Communication

Features :

Active game LED floor is a Revolutionary designed flooring system that incorporates interactive LED lights and sensors to create a fun-filled gaming experience. These floors can be used in various occasion, including gyms, play areas, game room, malls, and theme parks, to enhance physical activity and promote exercise. Suitable for people: single, multiple, parent-child, team construction, PK, etc. Can be satisfied from primary school students to adults.

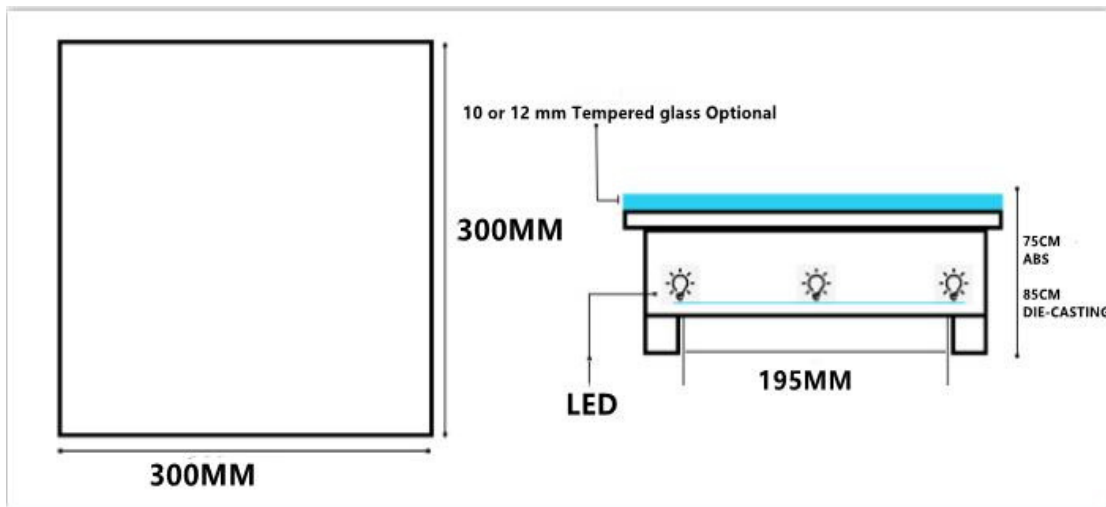

DIE-CASTING HOUSING

ABS Housing

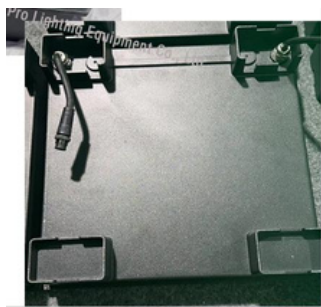

Floor male and female connector



Male: input



Female: output

Street Communication

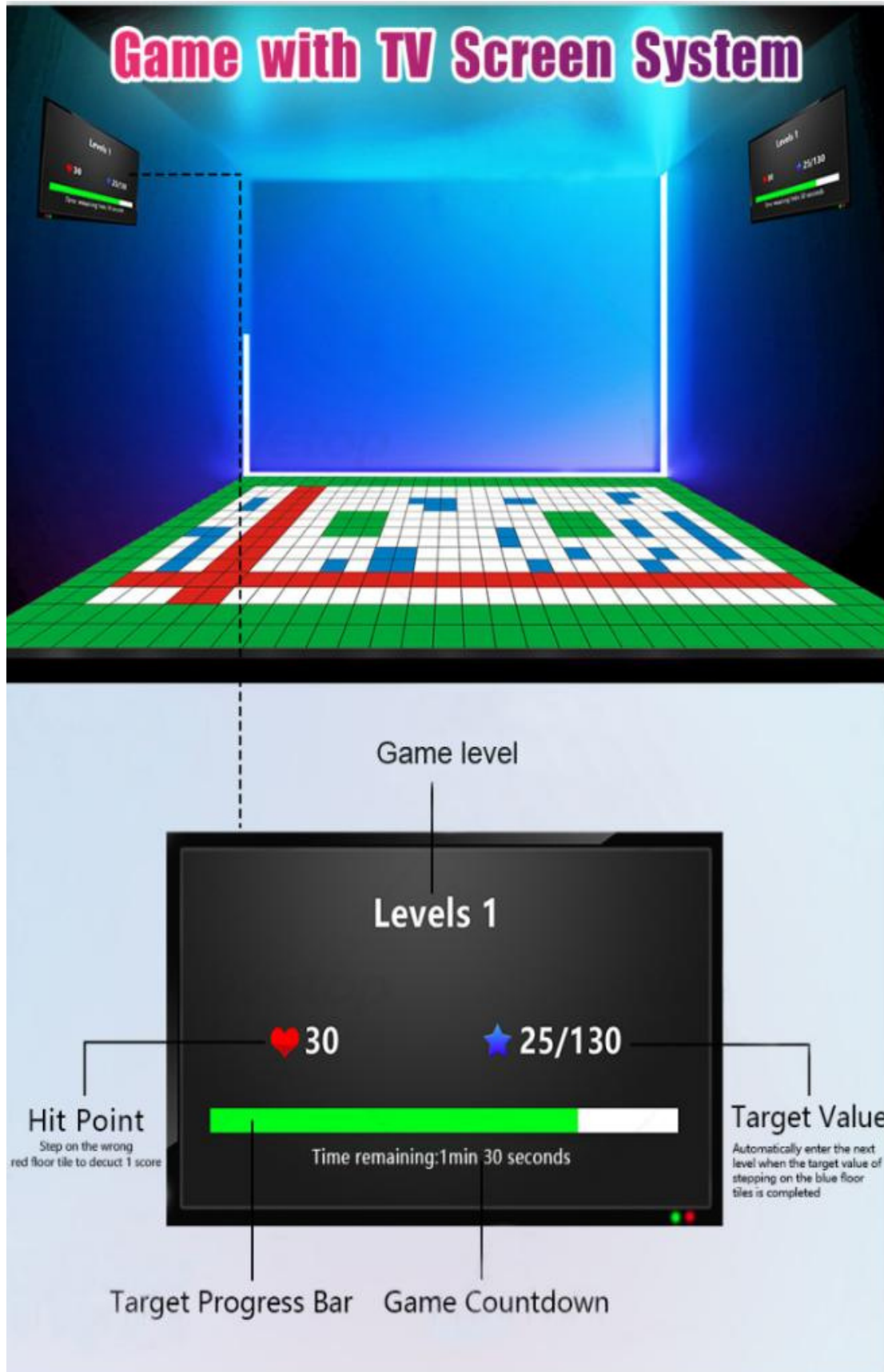

Street Communication

Game Design Software

Support free editing by users. Can customize configuration, games effects, gameplay. The sounds, background music and difficulty level of the games can be changed freely. You can create unlimited games to achieve any effect you want.

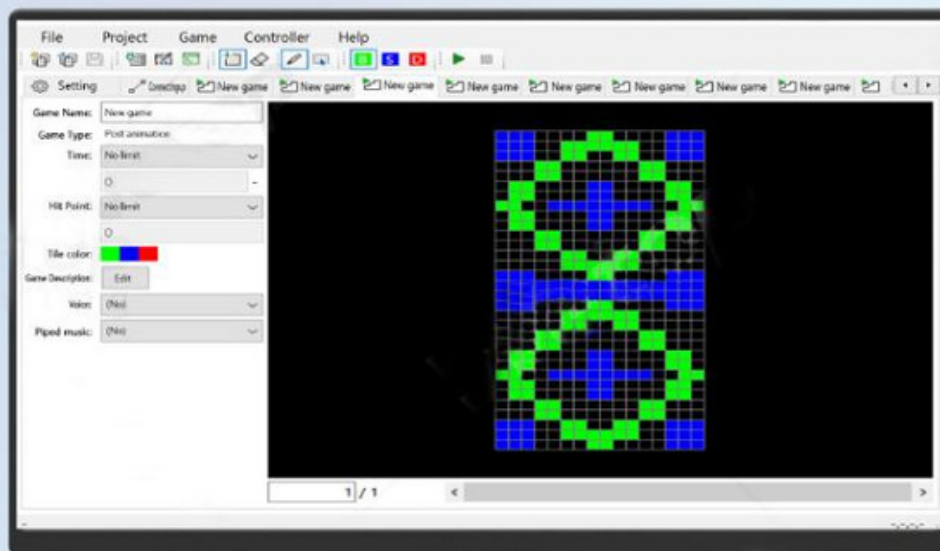
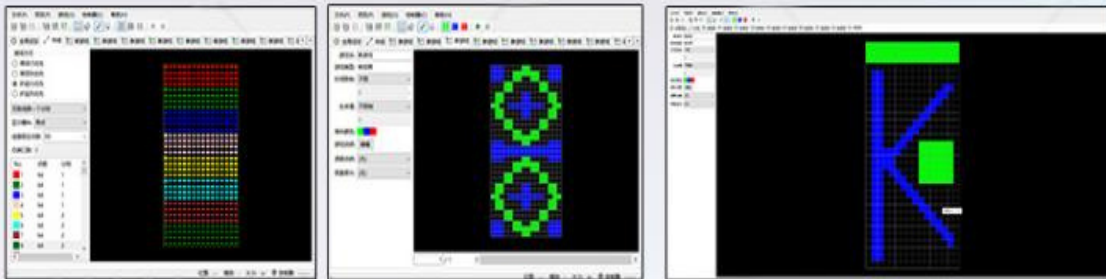

Street Communication

Introduction of gameplay

There are LED floor tiles with the same specifications and different colors in the game area (red, blue, green)

Red: danger zone

Green: safe zone

Blue:game score zone

Players not only need to avoid the red grid, but also need to stamp out the blue grid to get scores to pass levels and competitions, Games levels are changeable continuously, adjust the quantity, position and speed of blue grid & red grid to increase the game difficulty and achieve stimulation feel when passing level.(Supports upgrading to more game play modes and multiple game elements)

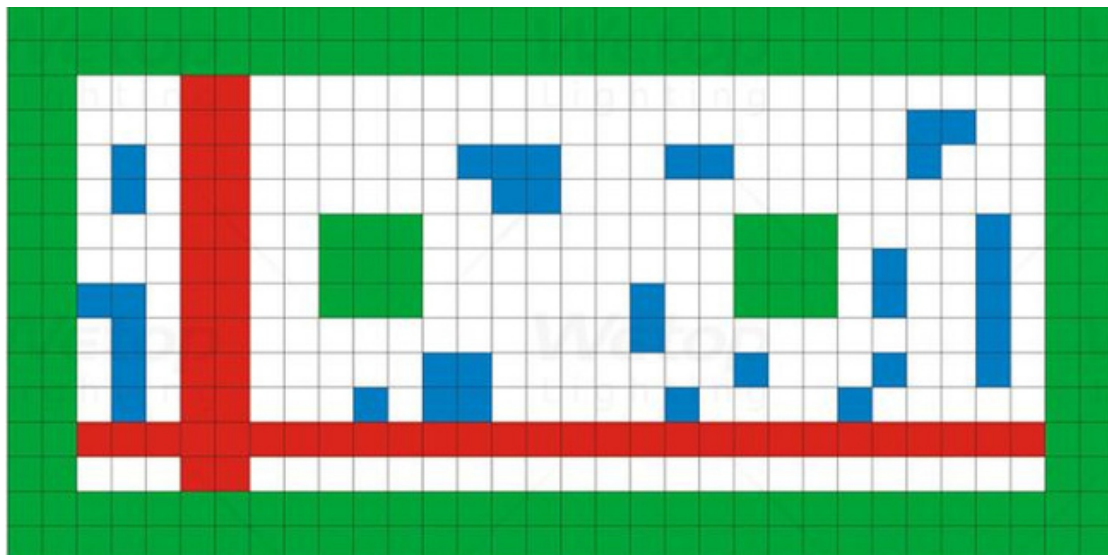

Suggested configuration of games room.

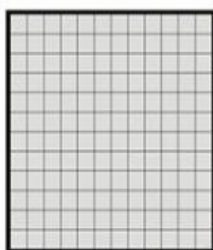

12x12=144 pcs

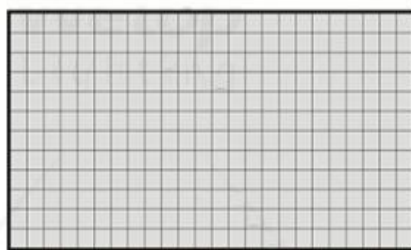

12x24=288 pcs

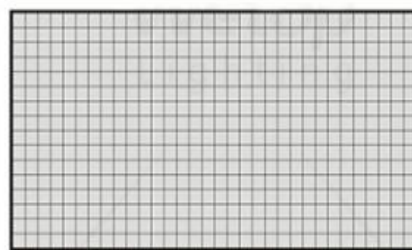

16x32=512 pcs

You can also customize the quantity and place it according to the actual venue

Street Communication

Installation details

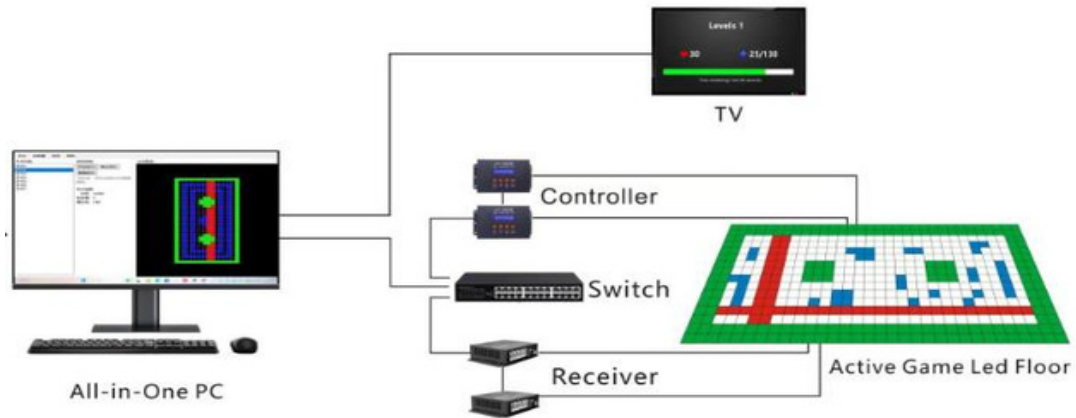

Easy to install

Fast connection: one second, one panel

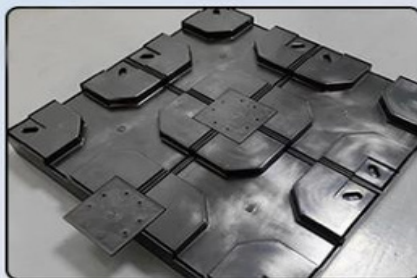
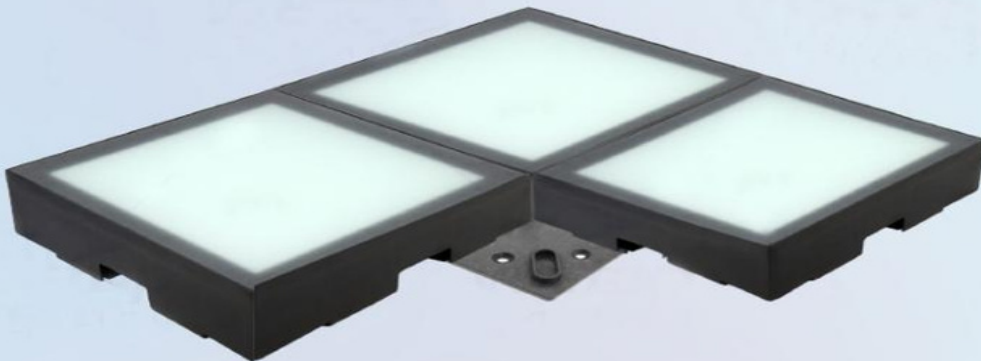

Wired connection interlock, panels can't be moved, stable and durable

Street Communication



Built in Sensor

Active game LED floor is a Revolutionary designed flooring system that incorporates interactive LED lights and sensors to create a fun-filled gaming experience.

Game Features

Various games

Active game LED floors can offer customizable game settings, allowing players to adjust difficulty levels and games modes. This makes the games more challenging and rewards players for their skills.

Multiplayer gaming

Active game led floors can accommodate multiple players at once ,making them ideal for parties and social events ,players can compete against each other or work together towards a common goal .

Interactive gameplay

Active game LED floor provides an interactive gameplay experience that traditional LED floors do not offer. Players can move around and actively engage with the game ,making it more fun and engaging.

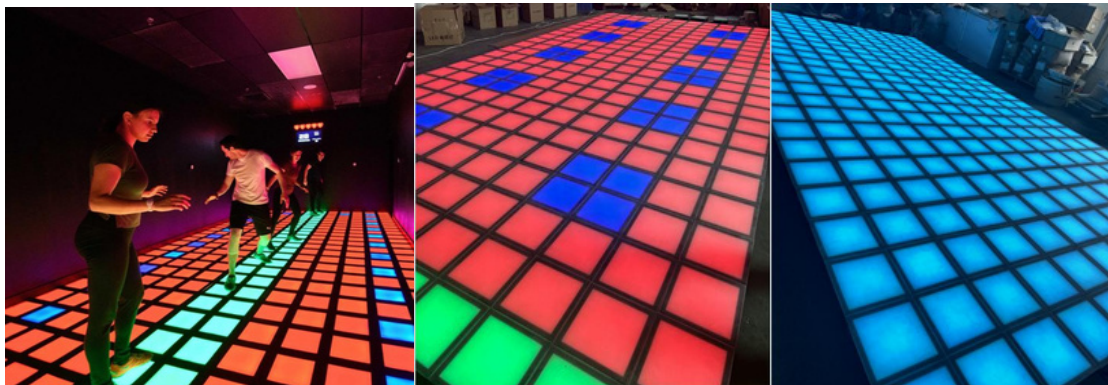

Street Communication for Game Night Kerpen

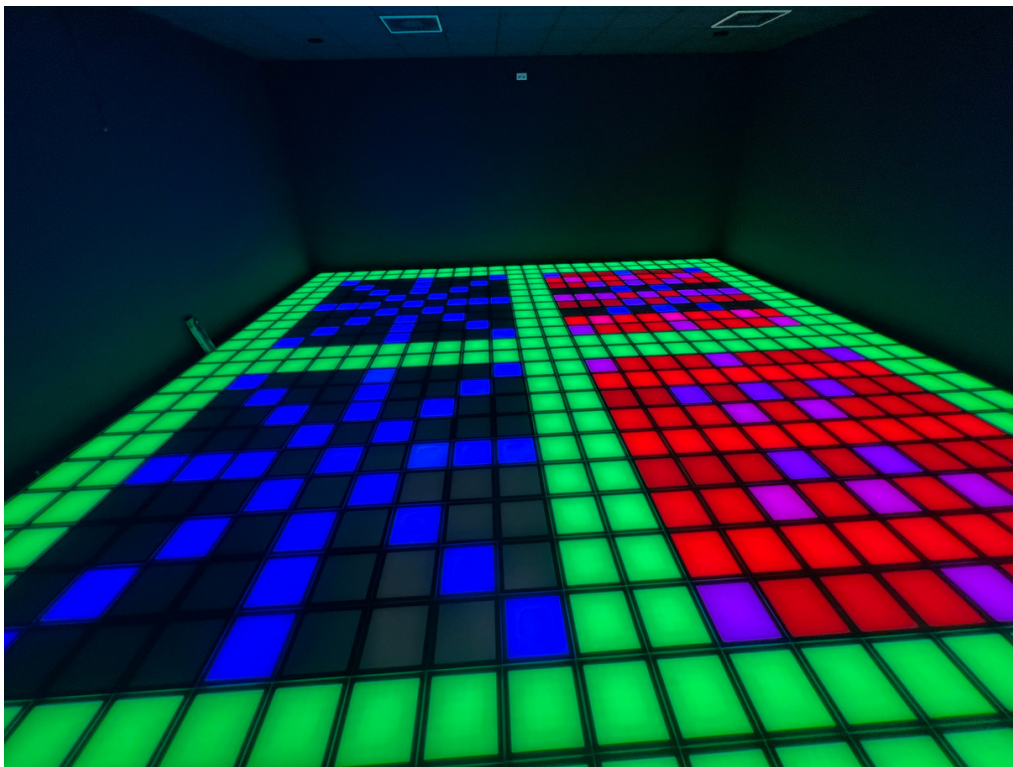
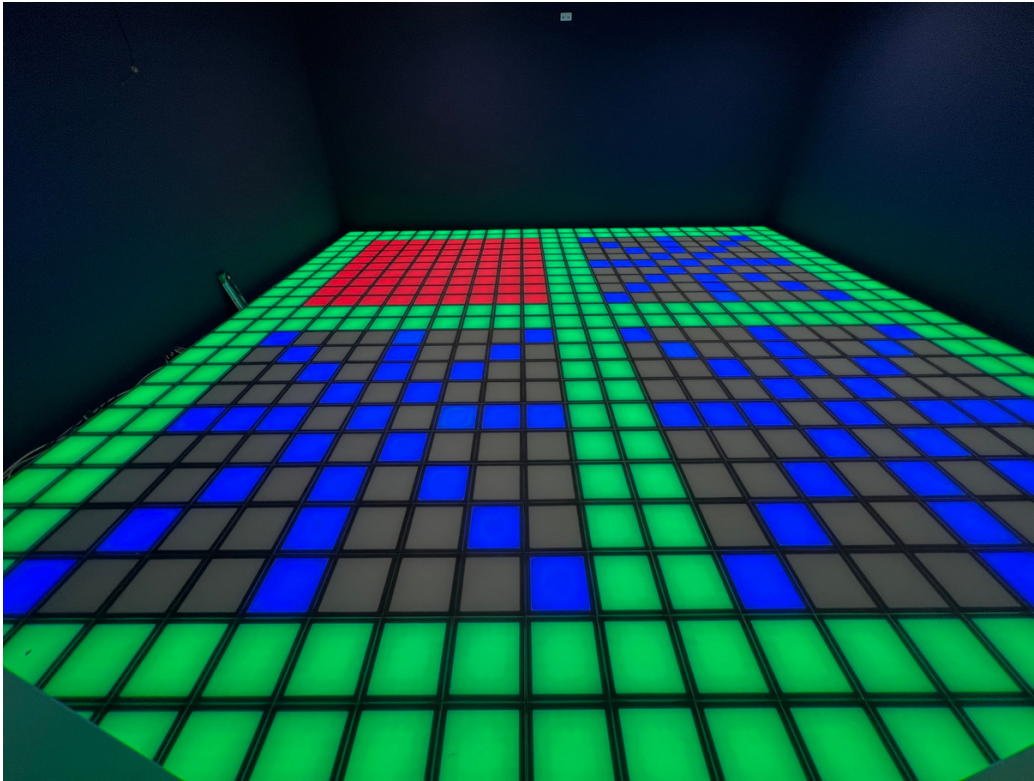



 **GAME NIGHT** 
KERPEN-SINDORF, COLOGNE