

A minimalist interior featuring a white door with a black handle and a light switch on a grey wall. The door is set in a white frame against a grey wall. The floor is made of light-colored wood. The overall aesthetic is clean and modern.

# MBS

Architectural

EZ Concept Lookbook  
**BROCHURE**



As manufacturers of the world renowned EzyJamb door jamb systems, EZ Concept's openings and finishings products produce minimalistic flush finishes by eliminating architraves, skirtings and traditional timber systems for commercial, residential and industrial interiors.

#### EXPERIENCE EZCONCEPT

##### Opening Products

### EzyJamb

Page 06 | The Flush Finish Door Jamb System

### RocYork

Page 12 | Door Hardware

### CavKit

Page 14 | Cavity Slider Trim Kit

### SlideSet

Page 16 | The Flush Finish Cavity Slider Solution

### AccessDor

Page 18 | Smooth Wall to Access Panel Transitions

##### Finishing Products

### EzyPelmet

Page 20 | Economical Recessed Window Pelmet Systems

### EzyCap

Page 22 | The Versatile Alternative for Stop Ends

### FastCap

Page 24 | Custom Rebates and Capping made Easy

### EzyReveal

Page 26 | Premium Architrave Free Window Reveals

### AluBase

Page 28 | Anodised Aluminium Skirting Board Trim



**Clean lines, flush finish. The complete solution for modern interiors.**

As manufacturers of the world renowned EzyJamb door jamb systems, EZ Concept's openings and finishings products produce minimalistic flush finishes by eliminating trims and traditional timber systems for commercial, residential and industrial interiors.

Explore our range of opening and finishing products.



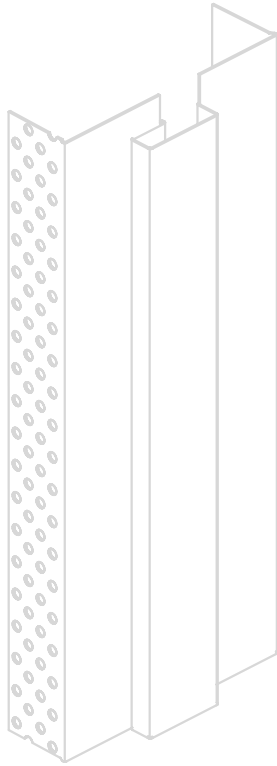

## EzyJamb

### EZC | Classic Adjust Door Frame

EzyJamb® Classic Adjust EZC is a split-type adjustable door jamb manufactured from cold rolled steel to produce a strong and secure assembly.

The EzyJamb EZC, comes with perforated sides for flush finishing which produces a contemporary flush finish door jamb with clean lines and inconspicuous detail.

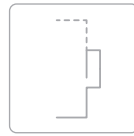

Split Type Jamb

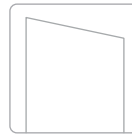

Flush Interior Finish

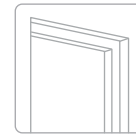

Rebated Exterior Finish w/ door stop detail



EzyJamb EZC profile with traditional door stop



EzyJamb EZC creates a flush finish on one side of the door

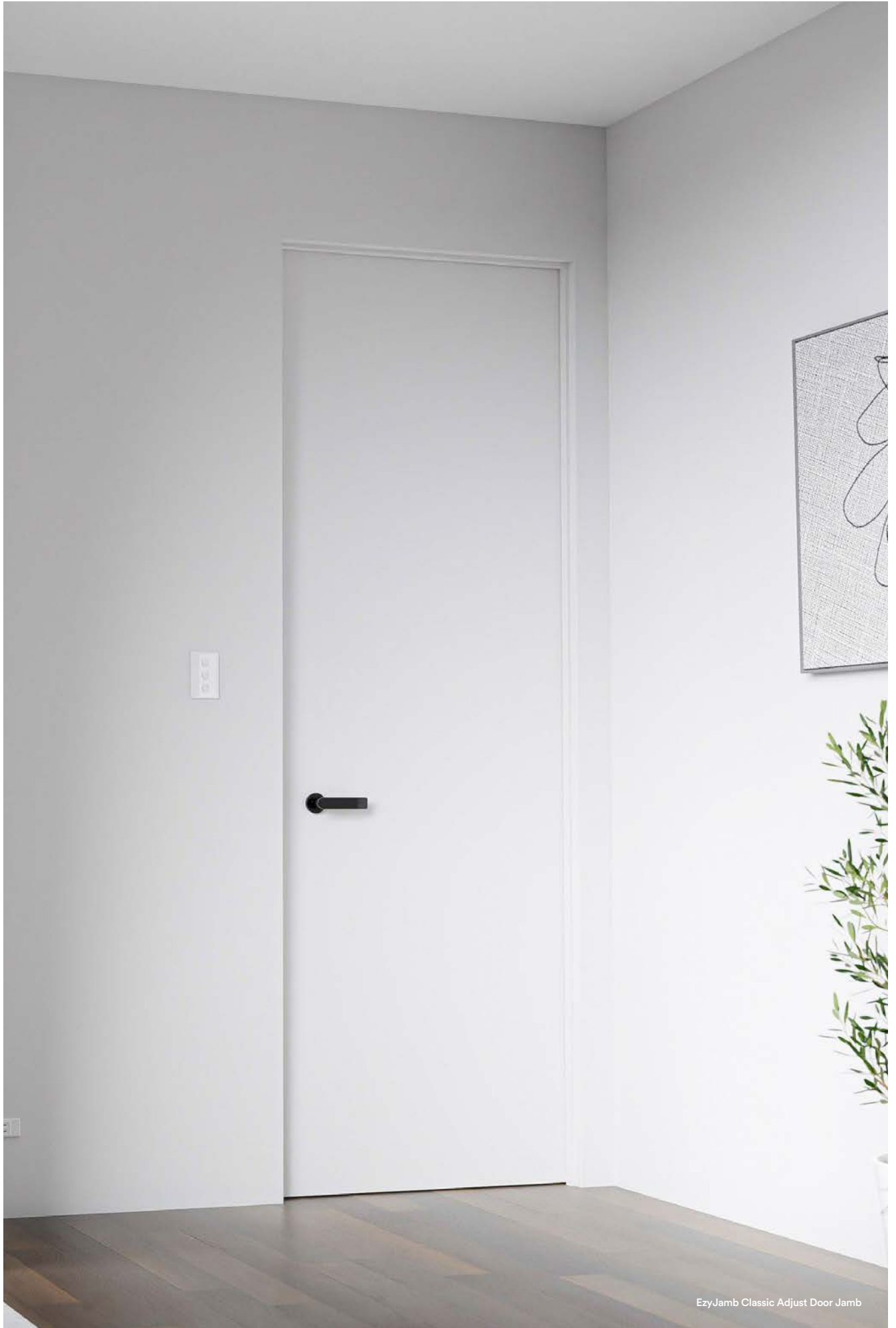

EzyJamb Classic Adjust Door Jamb



EzyJamb Single Rebated Door Jamb with RocYork Concealed Hinges

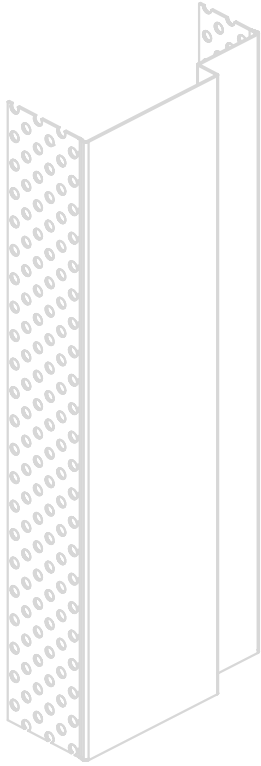

## EzyJamb

### SRC | Single Rebate Door Frame

The premium design of the EzyJamb SRC provides a smooth transition from one side of the door jamb allowing a minimalistic sophistication in apartments, homes and commercial buildings.

This one-piece frameless door jamb is made custom to perfectly suit your wall thickness for a flush finish.

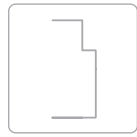

Single Piece Jamb



Flush Interior  
Finish

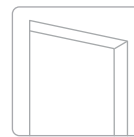

Rebated Exterior  
Finish

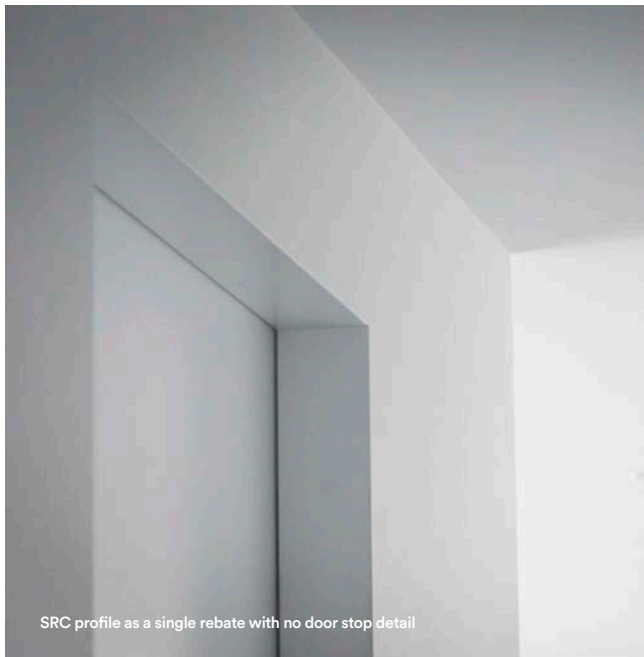

SRC profile as a single rebate with no door stop detail

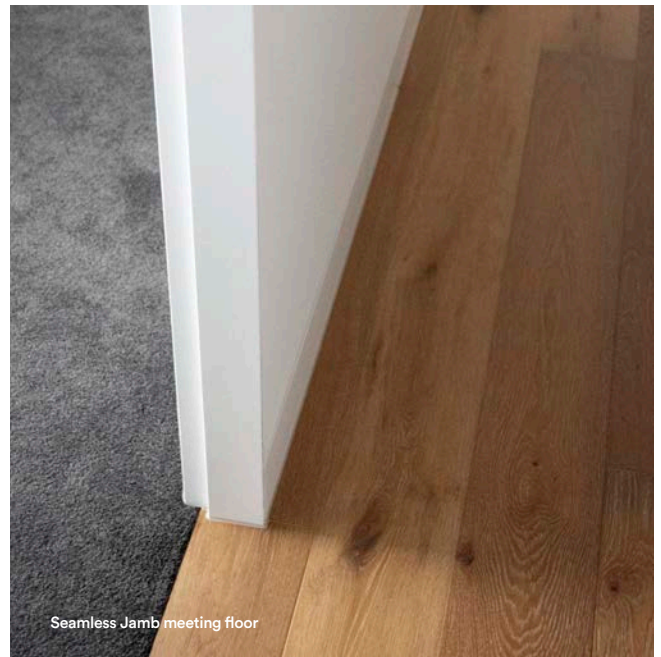

Seamless Jamb meeting floor



EzyJamb Inswing Door Jamb with RocYork Concealed Hinges

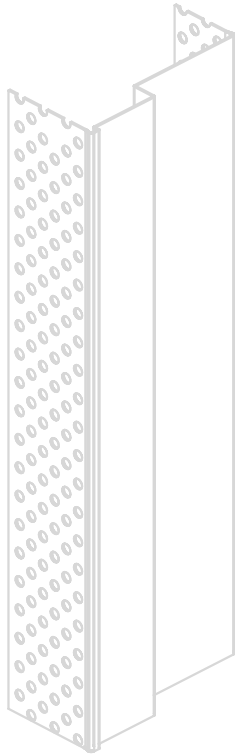

## EzyJamb

### ISD | Inswing Door Frame

EzyJamb® Inswing Door - ISD is the ultimate inswing door jamb system to achieve a seamless look in hallways and corridors.

The incorporation of reinforced edges overcomes the continual damage door jambs are subjected to by normal everyday use.

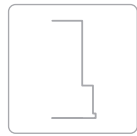

Single Piece Jamb

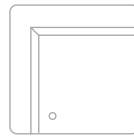

Rebated Interior Finish

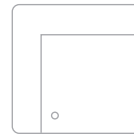

Flush Exterior Finish



Minimalist Design



Completely invisible door frame



RocYork RY-60 Concealed Door Hinge

Concealed hinges available in black, white, satin chrome or stainless steel

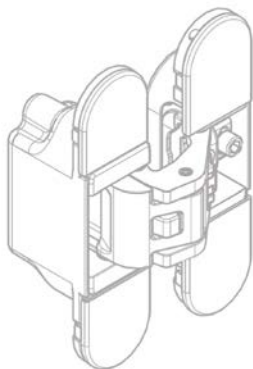

## RocYork

### Concealed Door Hinges

Make your door hinges disappear with the all new RocYork® concealed door hinge from EZ Concept.

This revolutionary architectural breakthrough will allow uninterrupted clean lines around internal doors for the ultimate square-set interior. Available in Satin Chrome and Black.



No visible barrel or in

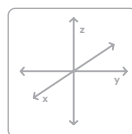

3 Axis Adjustment

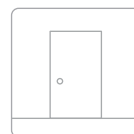

Usable with EZC and SRC



Liftoff hinges also available in black

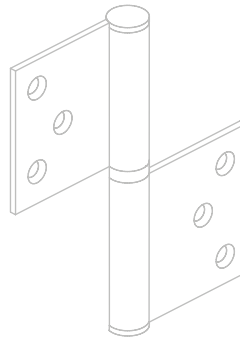

## RocYork

### Lift-Off Hinges

For greater flexibility, the RocYork Lift-off hinges are ideal for doors that require a service gap, such as apartment bathrooms, as they can quickly be lifted and removed without the need for unscrewing the hinge; saving time in an emergency.



Herline hinges also available in black

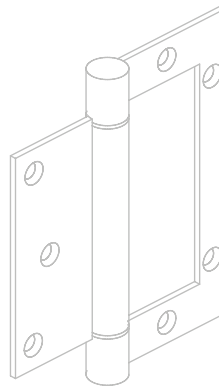

## RocYork

### Herline Hinges

Specially designed and manufactured to partner with the EzyJamb® door jamb systems, the loose pin RocYork® Herline Hinges are surface mounted with self-tapping screws, making them easy to install.

Available in Satin Chrome or Black.



Cavkit Trim kit with SlideSet Pocket Door

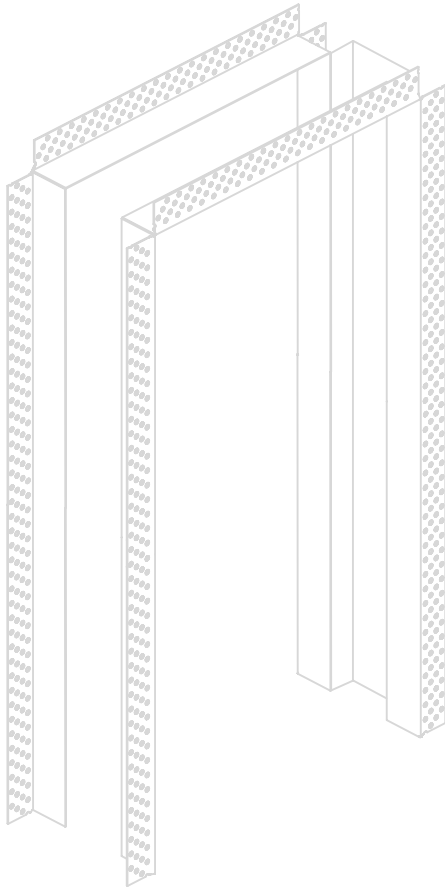

## CavKit

Trims to suit cavity sliders

CavKit is a flush finish system that trims and caps the plasterboard edges around the door penetration, to create a cavity slider that can be hidden when open and provide privacy when closed, without the look of bulky architraves. Designed to perfectly match the EzyJamb door jamb system for swing doors, the CavKit pocket door trim system allows you to create a consistent flush look across all of your interior doors.

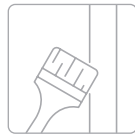

Ready to Paint

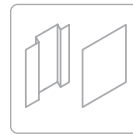

Rebated or flat end cap



Standard height CavKit opening

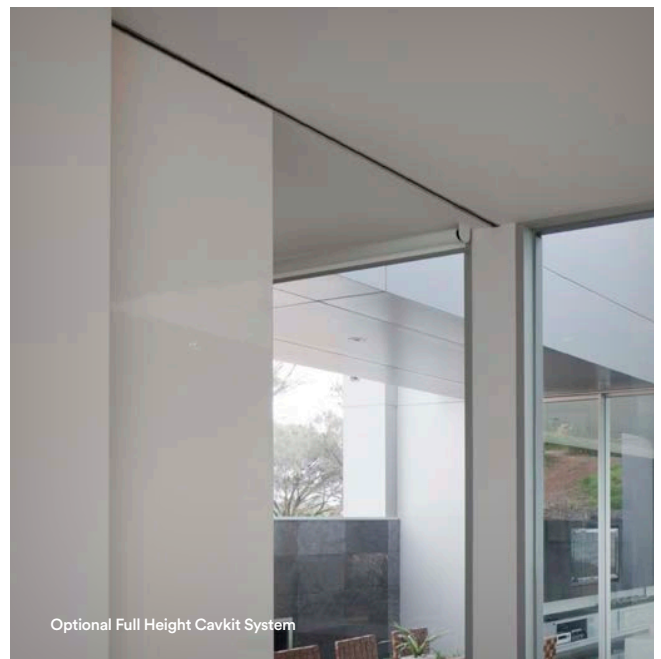

Optional Full Height Cavkit System



## SlideSet

### The Flush Finish Cavity Slider Solution

The SlideSet Flush Finish Cavity Slider System has been designed to provide the absolute minimum of detail giving the ability to completely conceal the door and give the impression that the door does not exist when open, and complete privacy when closed, adding a contemporary and architectural dimension to any project.



Preassembled  
Frame

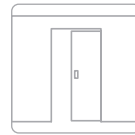

Architrave Free  
Door Frame

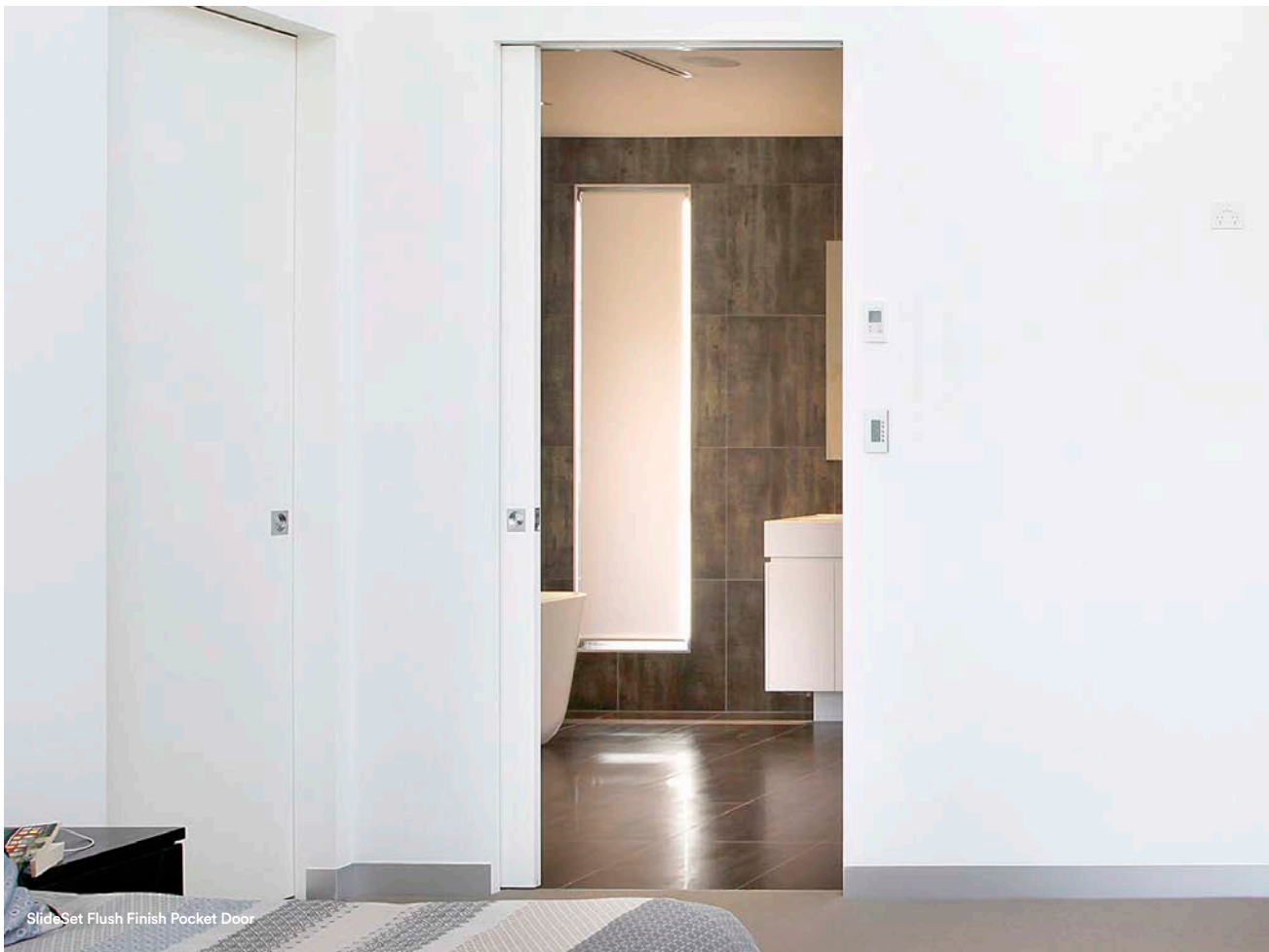

SlideSet Flush Finish Pocket Door

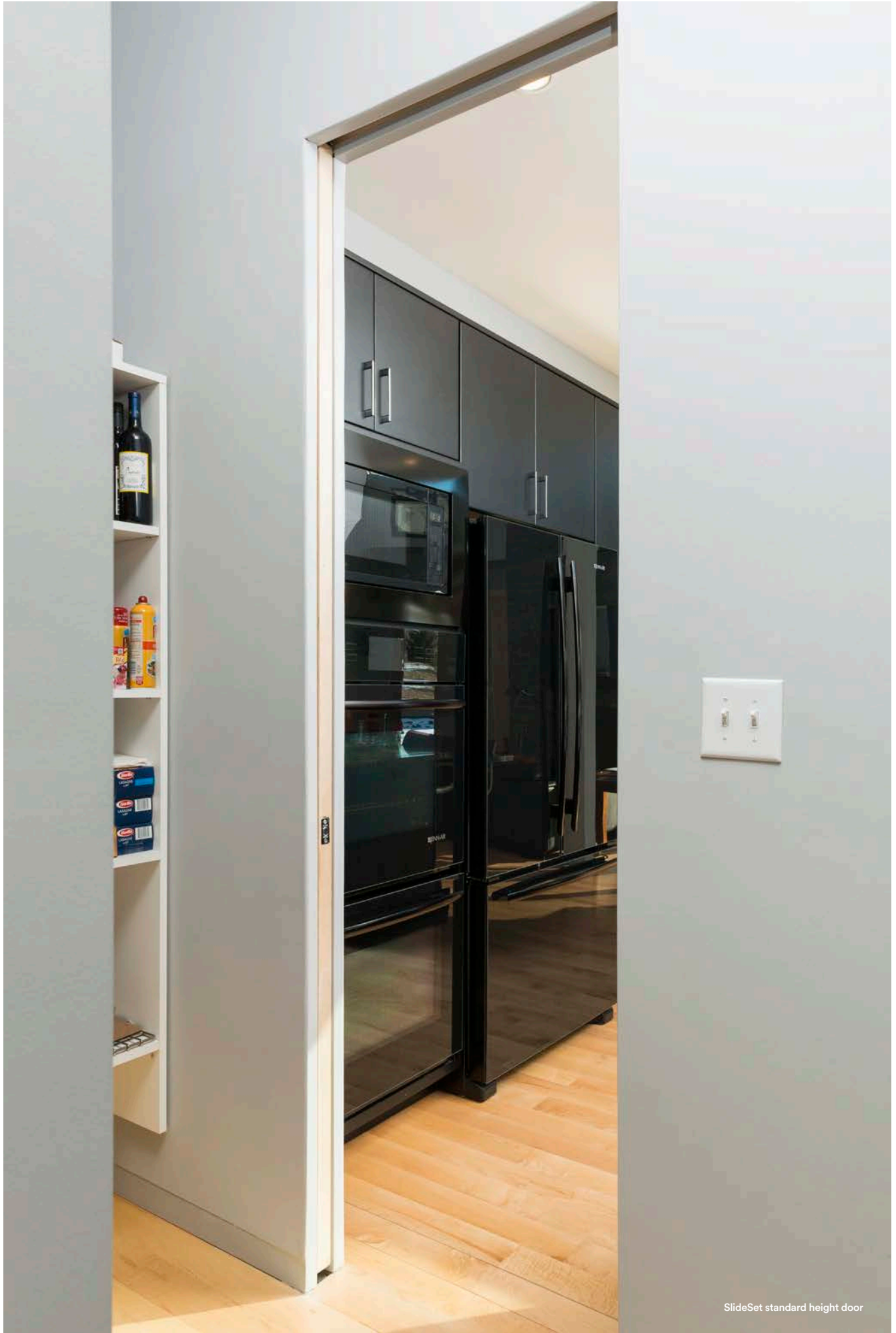

SlideSet standard height door

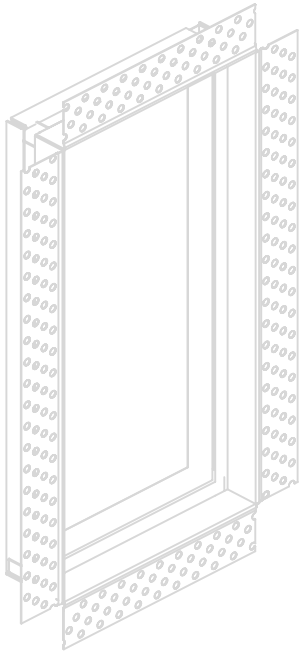

## AccessDor

### Smooth Transitions From Wall to Access Panel

Available as standard or custom solutions, AccessDor Access Panels are flush finished to the wall, with only a 3mm reveal between the door and wall and a discrete cam latch to inconspicuously blend into its surroundings.

Available in standard sizes or bespoke solutions; AccessDor can be suited to your specification. Combine your AccessDor with concealed hinges and latches for the complete flush finish look.



Various Latch Options

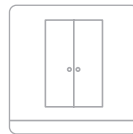

Flush Design



Screwdriver Latch Access Panel



Touch Latch Access Panel





Custom double door access panel



EzyPelmet Recessed Window Pelmet

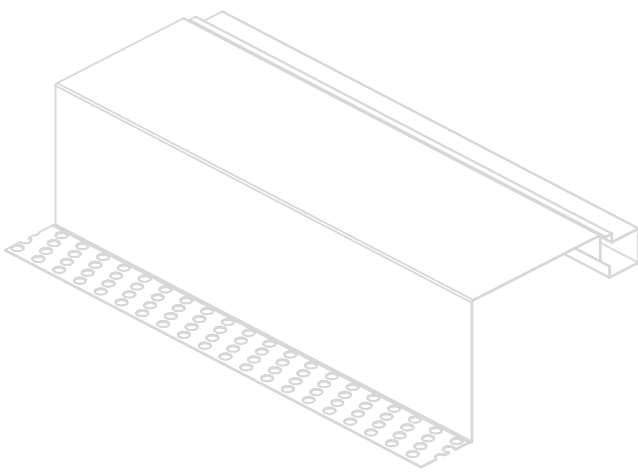
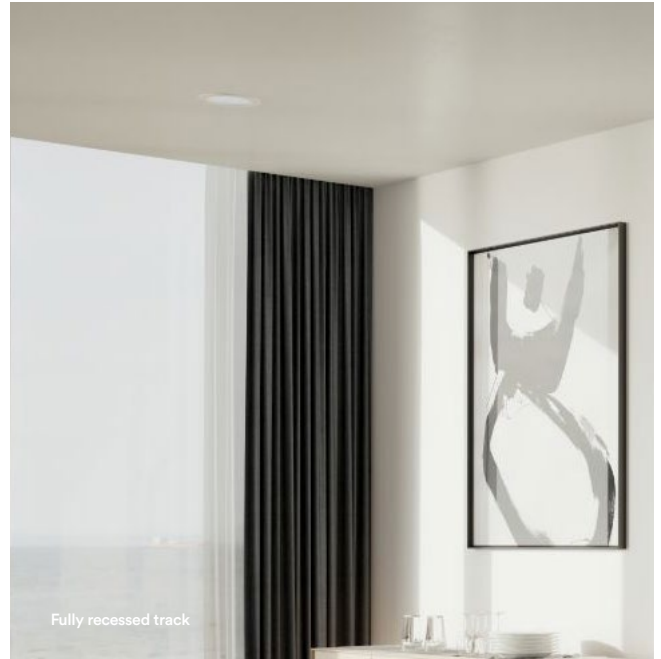

## **EzyPelmet**

### Two-Piece Pelmet System

EzyPelmet is a two piece, pre-finished cold-rolled steel section which provides a fast, economical and prestigious solution for creating recessed window pelmets in plasterboard ceilings.

It provides a simple and discrete transition between the interior ceiling and external windows, curtain wall facades or the building structure.

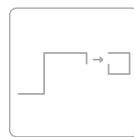

Two Piece  
Installation

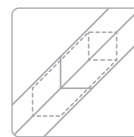

Concealed Joiner



EzyCap Wall End and Alubase Shadowline Skirting Boards



EzyCap Shadowline Wall End

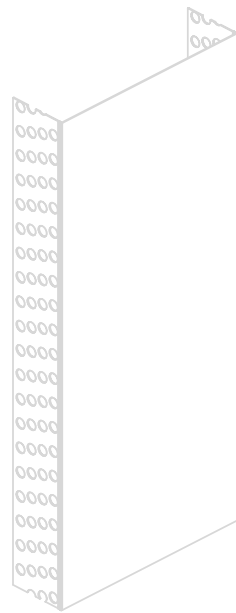

## EzyCap

### Window and Wall End Capping

Cased openings or internal wall ends are made easy with EzyCap.

Save time on site with this durable solution that simply slides onto the end of the plasterboard to cap the wall end and doesn't require preparation to paint in with the rest of the wall.

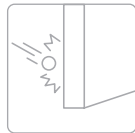

Wear Resistant



Ready to Paint

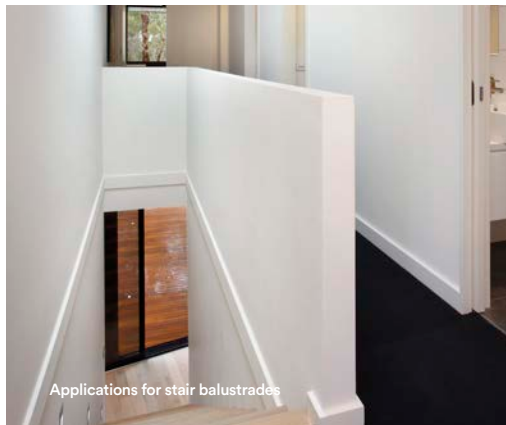

Applications for stair balustrades

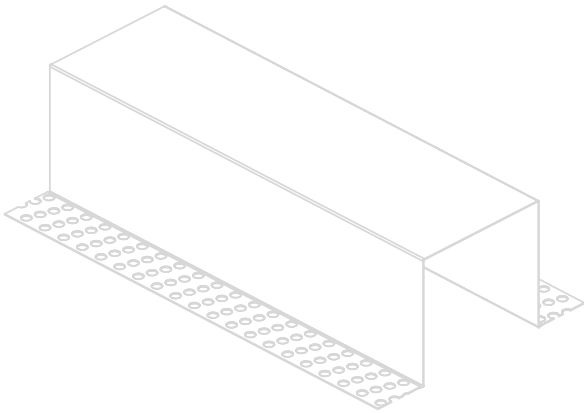

## **FastCap**

### Custom rebates and capping

Inspired ceiling designs command attention using FastCap; this innovative solution easily inserts between two sections of plasterboard to make light work of difficult rebates, plasterboard profiles and large oversized shadowlines. Recessing feature lighting or hardware, custom finishing and capping of plasterboard is made easy with the FastCap range of custom made finishing sections.

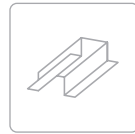

Single Piece Capping

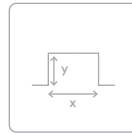

Opening Sizes



FastCap recessed lighting

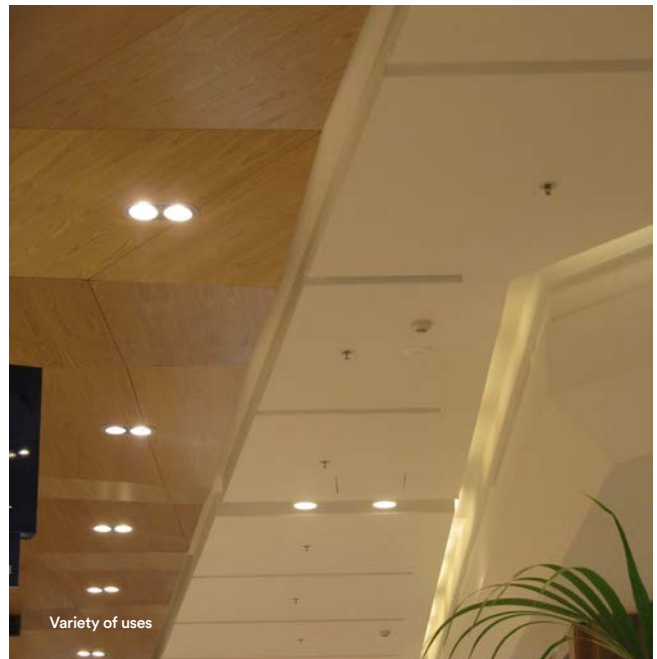

Variety of uses

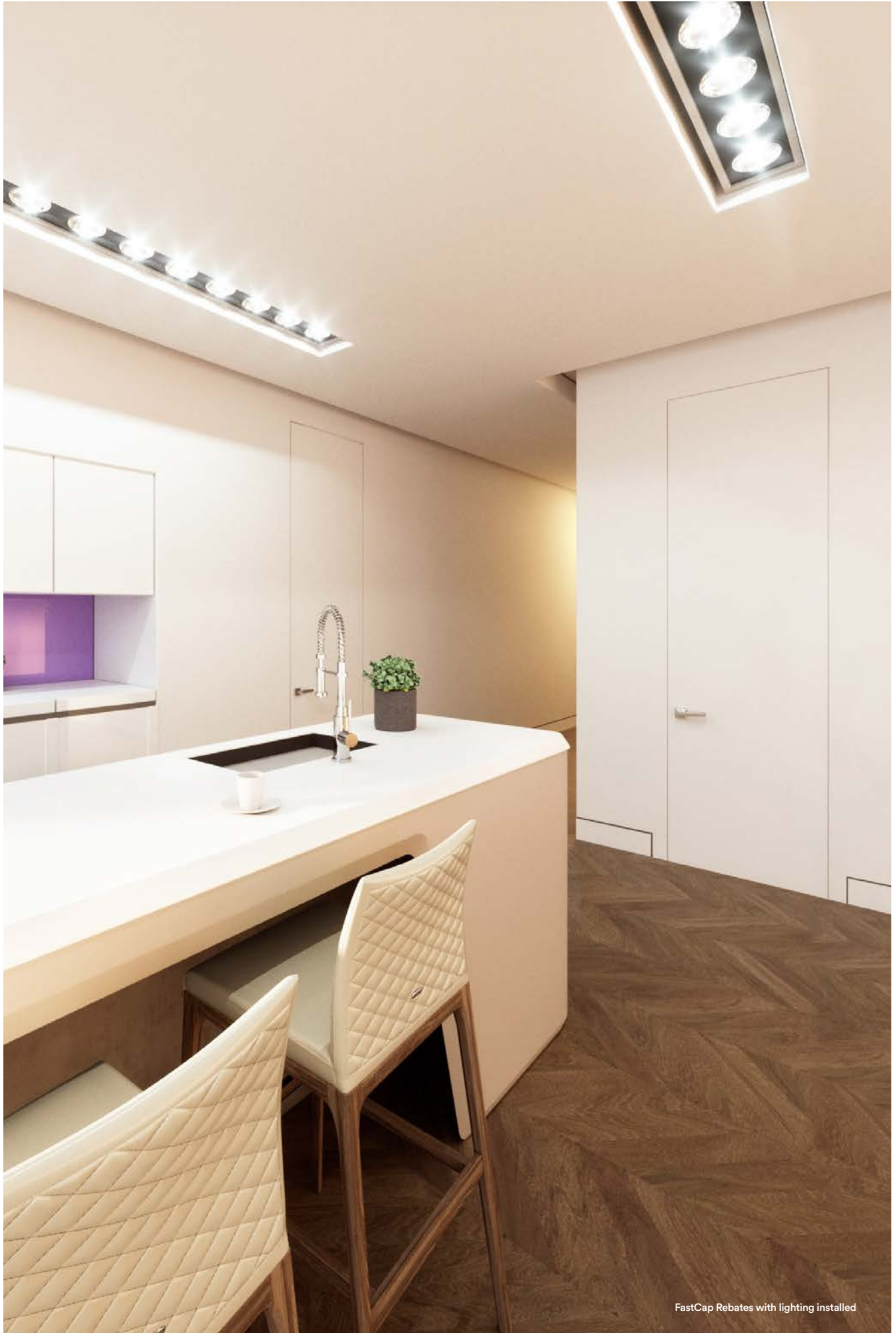

FastCap Rebates with lighting installed

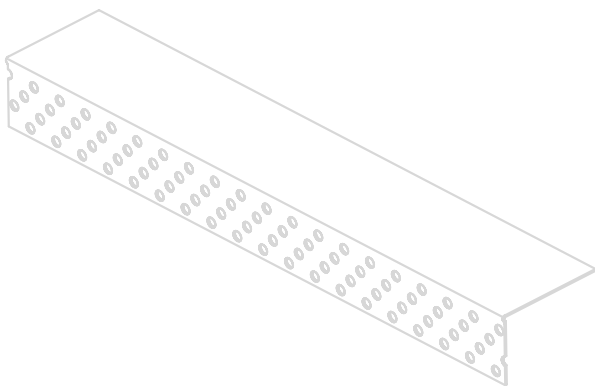

## EzyReveal

### Window Reveals

Create a premium architrave-free, square-set interior finish with EzyReveal®; the steel window reveal that eliminates the need for architraves.

Using a metal reveal is more durable than timber, as it doesn't warp or crack over time, especially in sun-exposed areas.



Architrave free Windows

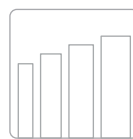

Variety of Widths



No Trims Required

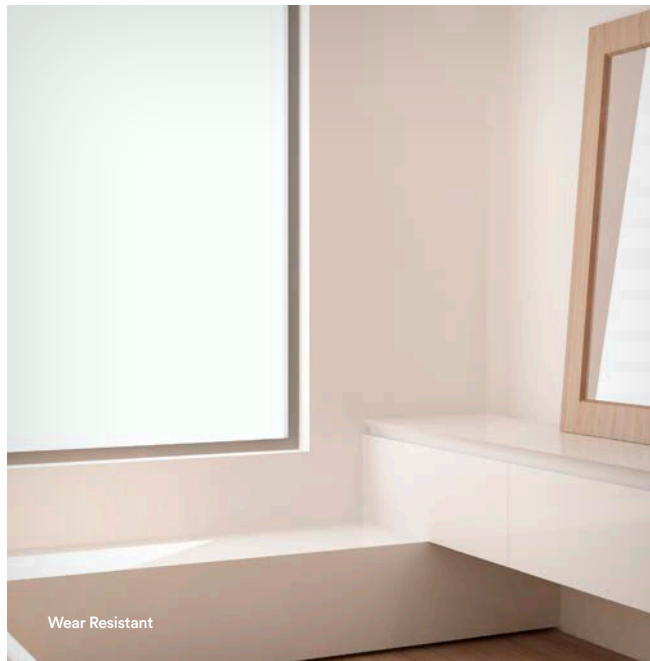

Wear Resistant





Flat Skirting



Shadowline Skirting

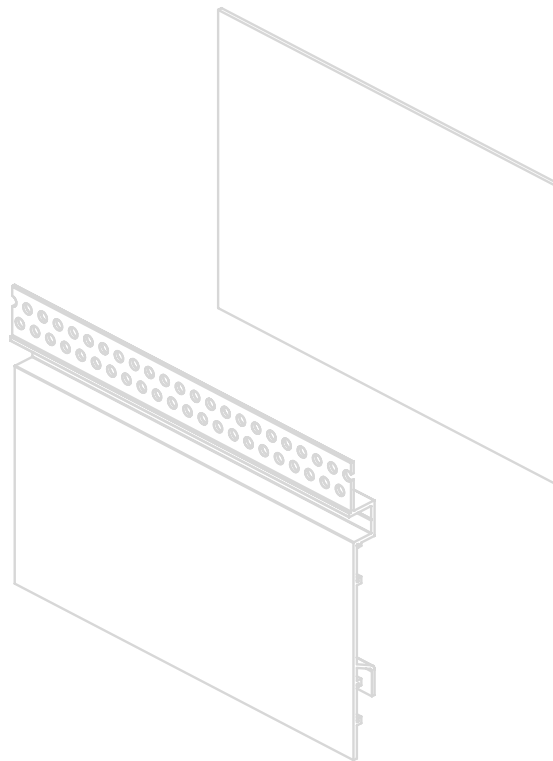

## AluBase

### Aluminium Skirting Boards

AluBase® Skirting Boards are a modern alternative to traditional timber skirting boards.

Providing a smooth flush finish that blends in with the rest of the EZ Concept range, designers can enjoy the benefit of eliminating the look of skirting boards for a superior interior finish.



Wear Resilient



Simple Edge  
Joining

# Environmental Awareness

Our commitment to environmental responsibility Studco Greensmart is an industry-leading initiative based on two simple principles.

Sustainable building technology innovation; and Practical sustainability leadership.

We are great believers in environmentally responsible business practises and in genuine investment for developing products that save energy and protect the environment. Our commitment to environmental responsibility and corporate accountability is evident in our ongoing certification to the internationally recognised benchmark standard ISO14001:2004 Environmental Management System.

When you build with Studco products, you can earn Green Star points for Green Star certified buildings.

Earn Green Star points with EZ Concept®.

Architects and interior designers have a unique opportunity to use EzyJamb flush finish door jamb to achieve a modern square-set interior without compromising the Green Star credentials for the building.

- EZ Concept products are made up from up to 30% recycled content in steel material.
- It's shipped in 100% recyclable packaging.
- There is no wastage generated on site.
- Manufactured under ISO14001 EMS policy.
- Talk to us today about earning Green Star points for your EZ Concept range.



# Ordering Guide

To request a quote or place an order with EZ Concept, visit [www.ezconcept.com.au/quote-request](http://www.ezconcept.com.au/quote-request) or email [sales@ezconcept.com.au](mailto:sales@ezconcept.com.au) for a request form. If you require assistance with placing an order, please call our team on 1300 399 526

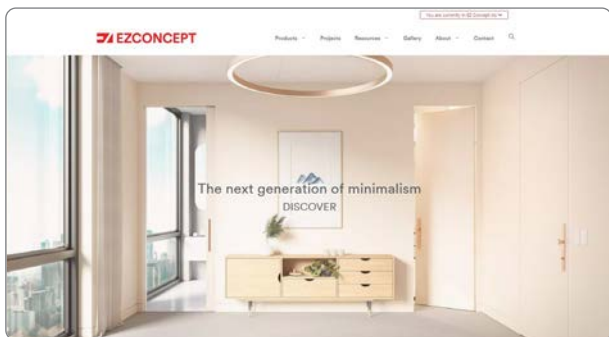

Website Main Page

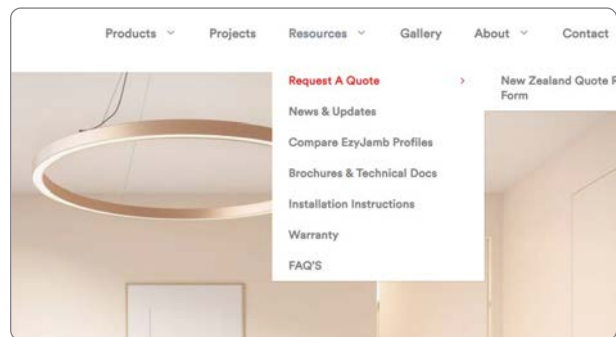

Navigate Resources > Request a Quote through Menu Bar

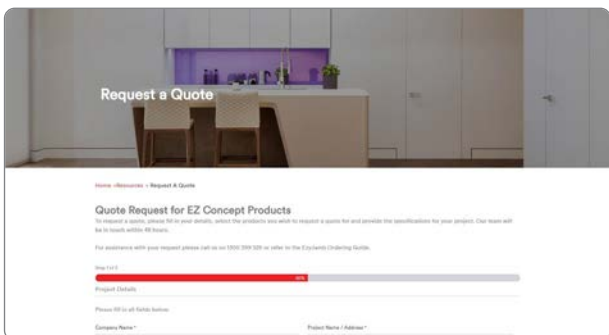

Quote Request Page

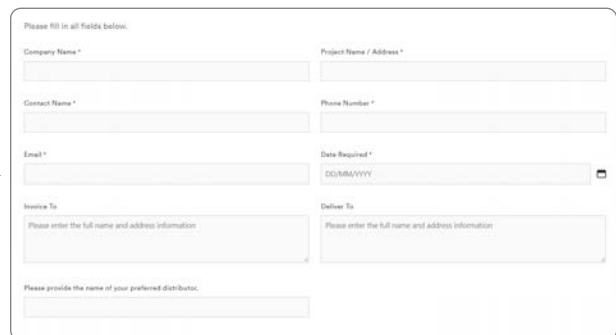

Fill in Project Details

## Delivery

---

EZ Concept are committed to providing excellent customer service to our clients to help you achieve flush finished interiors. We understand the need for tight delivery windows on site and are happy to work around site limitations to ensure your products arrive when required.

Our products are made to order and a typical lead time for delivery is five (5) working days. However, longer lead times may apply in some cases, so please confirm exact lead time with Studco prior to placing your order.

An expedited service is available on request for urgent orders. An extra charge per product is applicable to expedited orders. Expedition of EzyJamb, CavKit and SlideSet orders is subject to operational requirements. Always confirm exact lead time with Studco prior to placing your order.

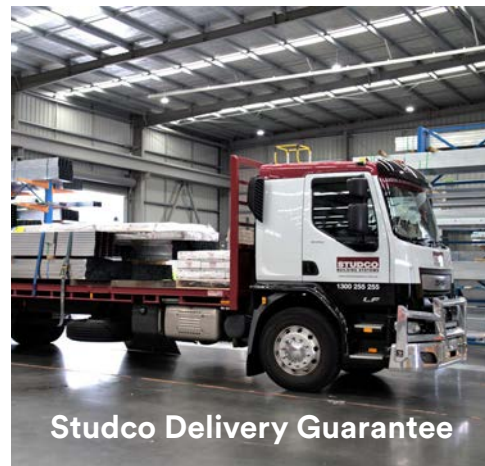

## Installation

---

All EZ Concept products are designed for quick and simple installation on site. Installation instructions are available on our website at [www.ezconcept.com.au/installation](http://www.ezconcept.com.au/installation) as well as installation videos for EzyJamb Ezc frames and RocYork Concealed Hinges.

If you require further assistance with installation, please call the EZ Concept team for technical advice on 1300 399 526.





Contact the team for pricing & samples

---

hello@mbsarchitectural.com.au | 03 9580 7800

**MBS**  
Architectural

Every material. One source.

Reach out to our team for support, samples and advice.

03 9580 7800

[hello@mbsarchitectural.com.au](mailto:hello@mbsarchitectural.com.au)

VIC | 7 Haymer Court, Braeside 3195

QLD | 13 Pease Court, Bethania 4205

@MBSarchitectural