

SAS **330A** ..[L]..

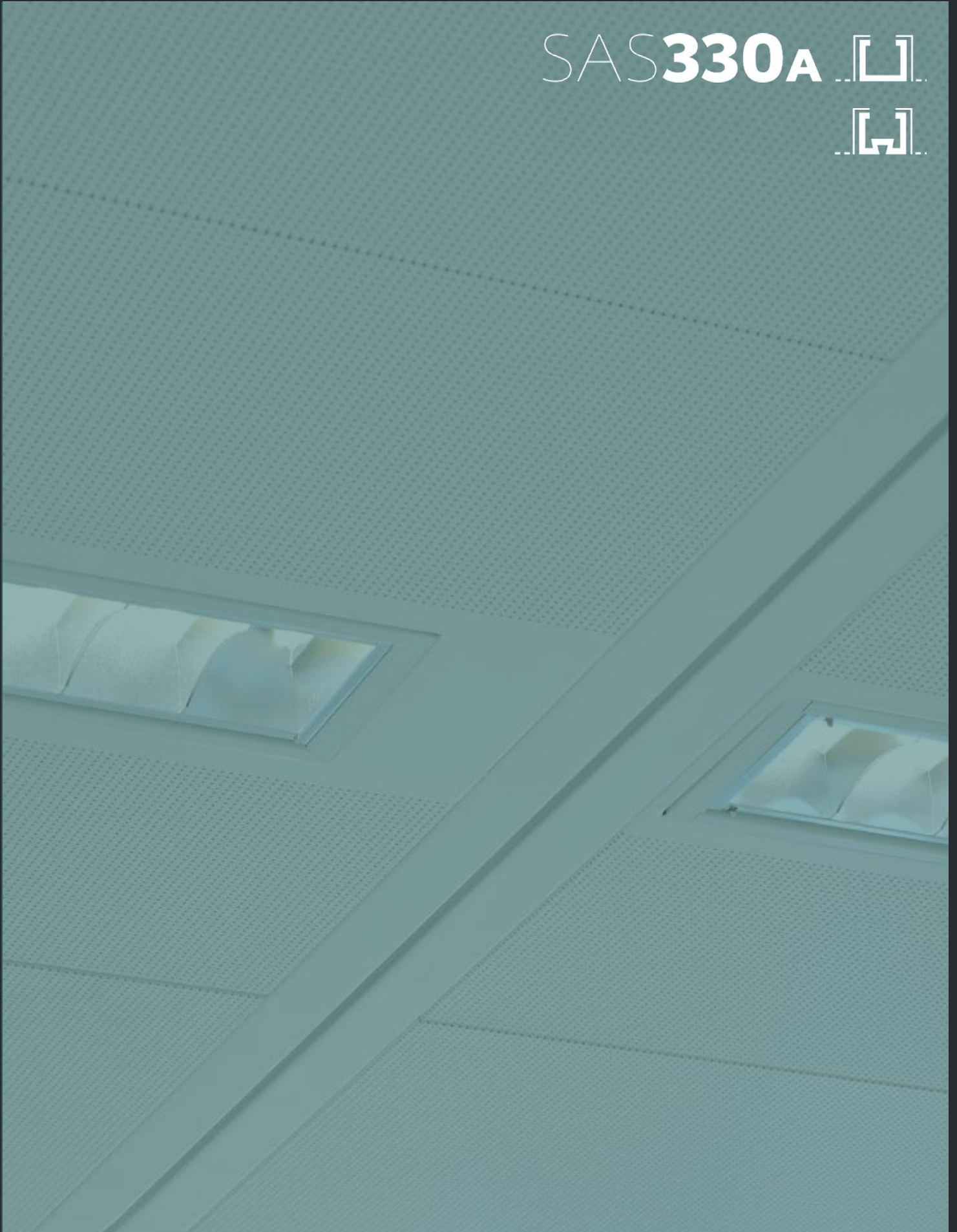

..[L]..



SAS330A



A highly versatile, premium suspended ceiling system with lay-on tiles and exposed grid.

SYSTEM GROUP	GRID
	
Suspended ceiling	Exposed grid – SAS C-Profile or Threaded C-Profile suspension

TILE

Lay-on

ACOUSTICS	
A-C	15-50dB
Absorption class	Insulation

ACCESS	SYSTEM WEIGHT	LIFE EXPECTANCY
	One-way grid approx. 14 Kg/m²	25yr
Lift and tilt	Based on 1500mm module	In excess of

***Note** This includes the entire system and full associated components (suspension, tile, acoustic pad and associated fixings.)

HAVE A QUESTION?

Configurable with other products. Call us. Contact us on info@sasint.com.au



A variant of SAS330, SAS330A is a versatile system which delivers on aesthetics and performance. This system has been altered so it does not have a proprietary grid, instead, the emac hangers are directly suspended from the c-profile. To stabilise this, distancing profiles are fixed to the hangers to ensure the ceiling is braced and spaced correctly.

Access

The secure void is completely accessible by removing the lay-in tiles, with no need for specialist tools.

Module Sizes

SAS330A ceiling tiles can be manufactured in mm increments up to 3m lengths. The specifier should note that maximum panel sizes are limited by industry tolerance guidelines.

Finishes

SAS330A is available in all standard SAS finishes, please refer to page 95. Bespoke finishes are available on request.

Perforations

SAS330A tiles can be manufactured with any standard SAS perforation pattern. For our full range of perforations, please refer to page 75. Bespoke perforations are also an option.

Acoustic Materials

Acoustic mineral wool pad with black tissue face, foil back and sides. Other acoustic materials are available depending on performance requirements, please refer to page 20.

Service Integration

Ceiling tiles and C-Profiles can be formed with apertures during manufacturing and post painted for integration with lights and other services. SAS330A panels may require stiffeners to support centrally mounted lighting.

Please note Additional loads applied to SAS330A ceiling tiles must not exceed 7Kg. Anything in excess of 7Kg requires independent suspension.

Technical Support

Please contact our technical team for all questions relating to access, security, bespoke features, acoustics, service integration or load support.

Grid Options

330A Grid

C-Profiles set out to run in one direction across the ceiling plane

C-Profile

A flush, smooth finish C-Profile available in a range of widths up to 300mm.

Threaded C-Profile

Featuring a continuous thread-form facilitating easy location and relocation of partitioning. By means of an M6 bolt, partitioning can be relocated without causing damage to the ceiling. Also available in widths up to 300mm.

C-Profiles in widths $\leq 150\text{mm}$ can be open ended, using splices to connect longer runs. C-Profiles in excess of these widths must be closed ends, butt-jointed and bolted to other profiles. A range of narrower C-Profile extrusions are available if preferred.

An optional foam gasket provides a tight seal between profile and tile. Gasket is supplied loose for on-site installation.

C-Profile Options

Applicable to both one-way and two-way.

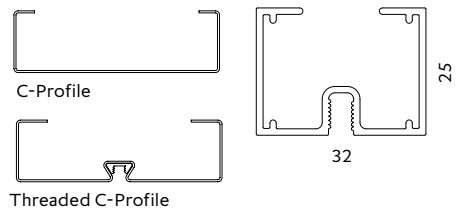

Threaded C-Profile



Perspective Drawing

- 1 Emac Hanger
- 2 C-Profile Extrusion Bracket
- 3 C-Profile
- 4 TCP 180s Splice
- 5 SAS330 Lay-on Tile (25mm deep)
- 6 Spring Pins
- 7 Distancing Profile

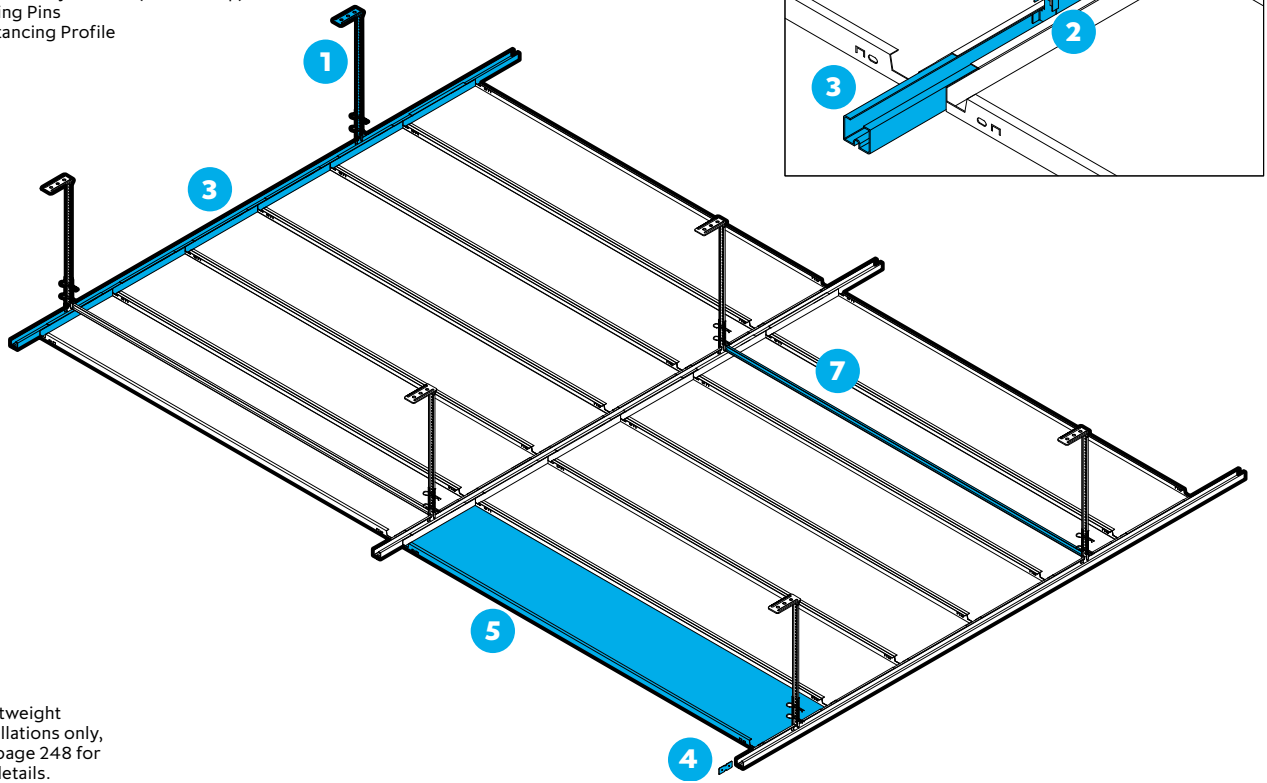

*Lightweight installations only, see page 248 for full details.

Section Drawing

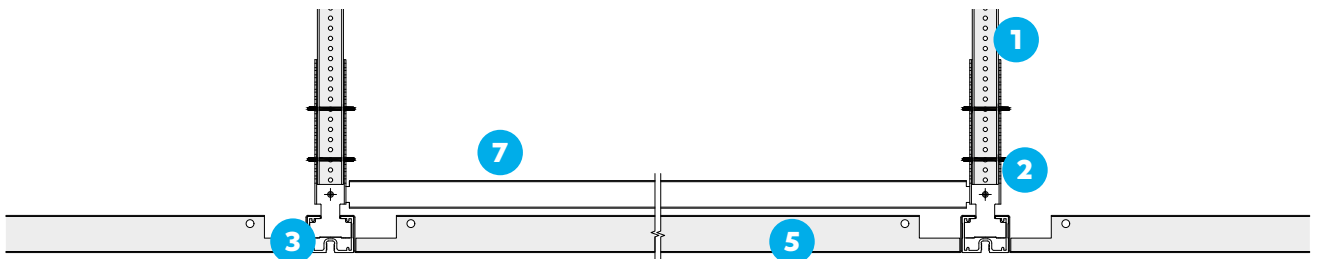



SAS**330A**

Gilbert + Tobin, Barangaroo

Location
Sydney, Australia
Architect
Woods Bagot

Contractor
Lendlease
Purpose
Commercial



MBS

Architectural

**INSPIRED BY QUALITY.
DRIVEN BY INNOVATION.**

Architectural Ceiling & Wall Systems

Reach out to our team for support, samples and advice.
hello@mbsarchitectural.com.au | mbsarchitectural.com.au

VIC
03 9580 7800
7 Haymer Court
Braeside 3195

QLD
07 2116 0717
13 Pease Court
Bethania 4205