

MBS
Architectural

Studco Product Catalogue
VORTEX HIGH PERFORMANCE FRAMING SYSTEM



Contact the team for pricing & samples

hello@mbsarchitectural.com.au 03 9580 7800

Studco Australia Pty Ltd

ABN 39 145 053 925

STUDCO HEAD OFFICE

Suite 2-5 120 Beresford Rd, Lilydale Vic 3140

Phone: (03) 9737 2500 Fax: (03) 9737 2555



The most important evolution for internal wall construction in 50 years

Modern tall buildings often experience loud, uncontrolled 'creaking' noises which emanate from the internal wall structure. Through extensive research, Studco has developed a method for reducing the stress and tension within the wall system that is a major contributor to the cause of the noise annoyance.

Revolutionising the way internal walls are constructed, Vortex High Performance Wall System from Studco is a breakthrough high-performing internal wall system that improves the behaviour of the wall structure in modern buildings.

Committed to best practice through ISO 9001 and ISO 14001 certified Quality and Environmental Management Systems; Studco Vortex conforms to all relevant Australian Standards and supports compliance to the Building Code of Australia.

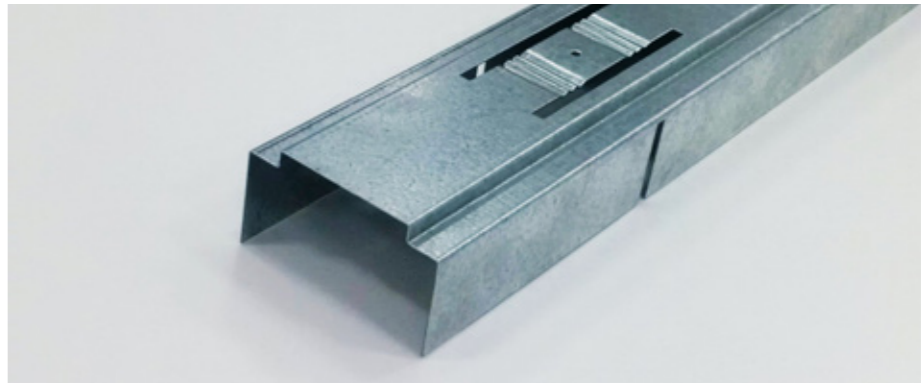

Studco Vortex segmented rebated track

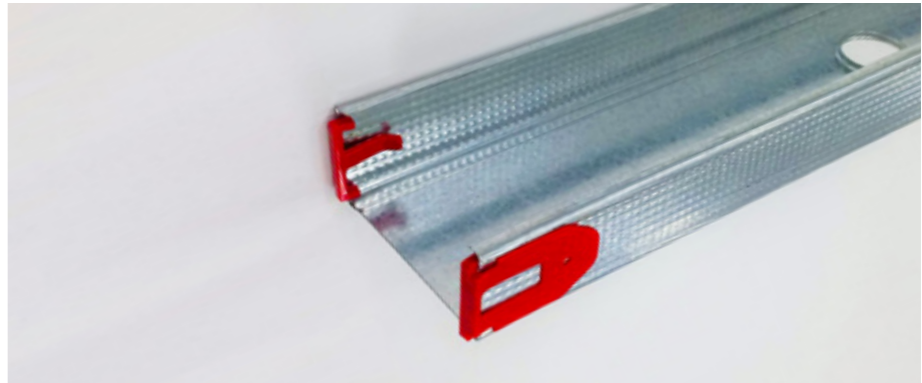

Studco Vortex stud isolation clips

VORTEX
HIGH PERFORMANCE FRAMING SYSTEM

Studco Vortex System

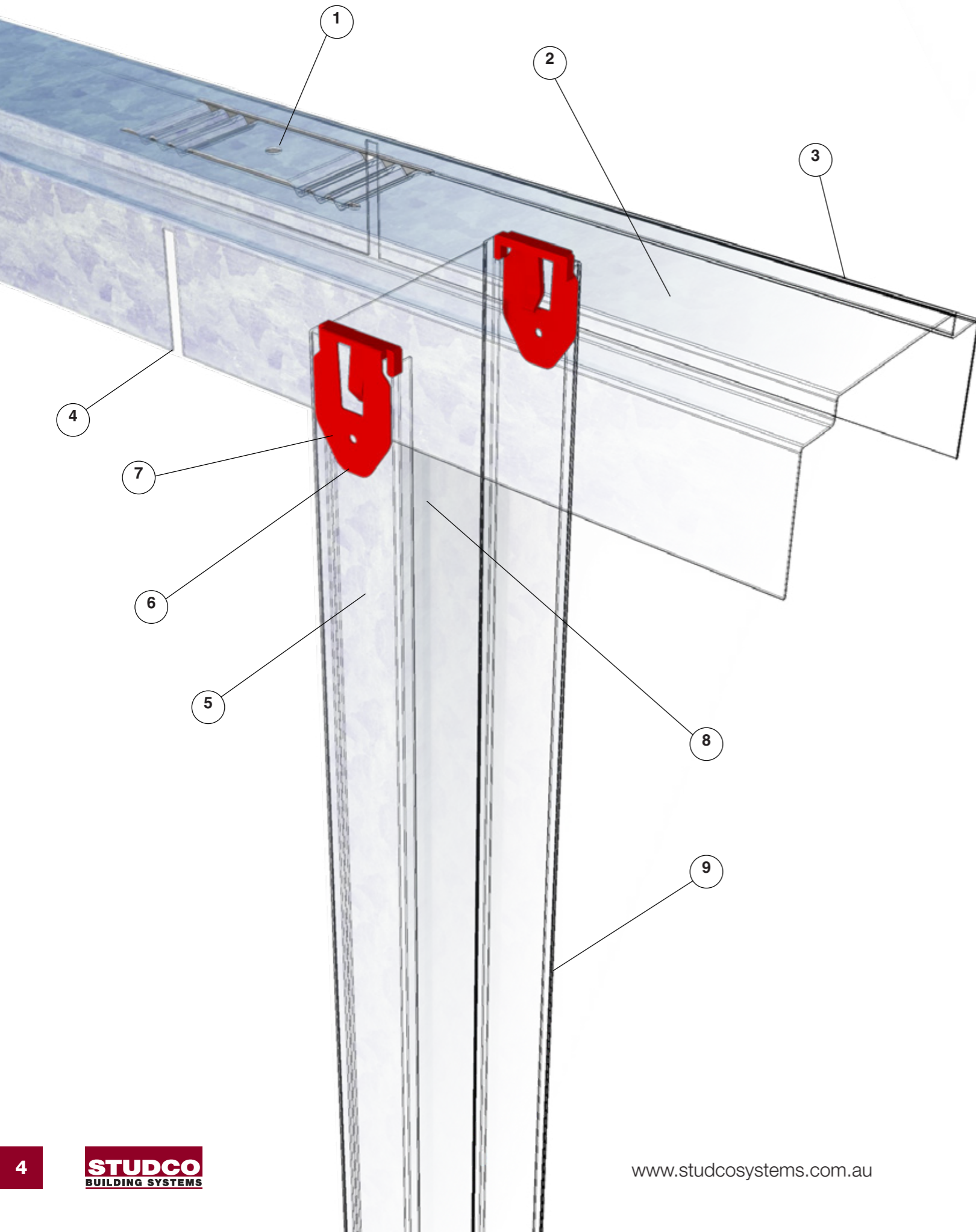

System Benefits

The patented Studco Vortex High Performance Framing System is a fit-for-purpose internal, lightweight steel framing system that has been specifically engineered to address the variable surface elements of modern concrete structures and the dynamic external forces experienced by tall buildings.

Studco Vortex High Performance Framing System is one of the most reliable and practical solutions for addressing the root cause of noise annoyance and is widely accepted in tall building construction as a best practice methodology.

Fixing Tab

- 1 Allows positive fixing to substrate on uneven surfaces. Concertina zone is pre-stressed to limit tension and deformation of the track.

Rigid Beam

- 2 The Studco Vortex top track profile has a full-length rebated pan that increases stiffness and resists buckling forces, to ensure profile straightness and restrict members from following undulating concrete surfaces.

Wide Range of Applications

- 3 Suitable for use in internal wall applications, including where vertical deflection is present and can be used at head and base of wall. Also used for fire-rated walls and acoustic walls.

Anti-Tension Kerfs

- 4 Strain-relief kerfs provide a secondary measure to limit deformation of the flanges where the substrate is extremely uneven. This disallows the transfer of tension along the profile length.

Stud Isolation From Track

- 5 Stud isolation clip isolates metal-on metal contact at the stud to track connection. Can also be used as a locator or shoulder in other wall construction elements.

Superior Wear Resistance

- 6 High density, hard wearing, low friction polymer material with fire-retardant properties.

Quality Control

- 7 Lower portion of the red isolation clip is highly visible and protrudes past the track flange for quick visual confirmation of installation and provides an easy way to check overall stud length.

Multiple Uses

- 8 Isolation clips can also be at the base of wall studs, as locators for doors jamb studs, furring channels and ceiling wall track sections.

No Noggings

- 9 In some wall configurations, noggings are not required.

Research & Development

Wind Studies

Studco led a collaborative research project into noise annoyance in tall buildings in conjunction with key stakeholders in the construction industry. The Studco Vortex High Performance Wall System evolved as a solution over a two year study period which analysed data from global wind studies, field investigations and audio recordings of tall buildings with known problems. Prototype systems were then laboratory tested by Deakin University and the final design was installed in skyscrapers and tested.

Initial findings singled out that high wind events were a common cause for noise annoyance in high-rise buildings and as a result of this, it became a primary focus for the research conducted.

Field Investigations

Inspection of concrete substrate surfaces unveiled several issues with the wall fixing interface, including misaligned formwork, residue concrete and debris attached to the concrete. In some cases, the concrete surface had ridges and obstructions up to 10mm high and over a relatively short distance, the level of the surface varied 10-20mm, providing an uneven surface for internal walls to be fixed to the structure.



Misaligned formwork was identified as a contributing factor to tension in internal framing.

Data Analysis

For several months acoustic recording devices were installed into buildings with reported noise problems to capture the noises a resident would typically experience. To determine the exact source of the noise annoyance, walls and ceilings were removed in existing buildings and acoustic source localisation methods were employed using a dispersed microphone array.

Analysis by PKA Acoustics identified individual noises and their location within the targeted building structure. This process singled out the noise emitting from the internal wall framing and was cross referenced against wind data recorded from the Australian Bureau of Meteorology.

Analysis concluded that noise annoyance occurred mostly during high wind events. The high winds induce aggressive vibration in the building structure, generating a creaking noise at the head track. Due to the tension caused by the uneven concrete substrate this noise has been measured at levels reaching 58db.

Amongst built up cities with a large concentration of high-rise buildings, a phenomenon known as vortex shedding occurs. This natural effect is caused by wind as it flows around buildings in an oscillating pattern causing vibrations across the building structure.

Further analysis of multiple wind tunnel test reports from highly populated cities uncovered that vortex shredding was linked closely to vibration and tension related noise.

By accessing ceiling and wall cavities, several buildings with known issues were investigated. This included employing infrared cameras to locate the source of movement and possible causes of noise annoyance. Numerous construction projects were monitored over the two-year research period to gain an insight into common installation practices. This provided an understanding of the on-site constraints that confront internal wall installers.



Formwork residue and concrete debris often present uneven fixing surfaces which are not made good prior to wall installation.

Product Development

From the evidence discovered during Studco's studies, it became clear that new problems require new thinking. Using 3D modelling and finite element analysis; the Studco Research & Innovation Team collaborated to produce a practical solution to noise annoyance in internal walls. Initial digital prototypes were tested through construction simulations to verify the performance in high tension applications.

Emphasis was placed on removing the tension from the metal components in the wall system and isolating metal-on-metal connections, whilst still achieving the desired structural, acoustic and fire rating outcomes of the wall system. The final prototypes were subjected to our verification processes which included critical appraisal from stakeholders across the full spectrum of the construction industry.

Testing

Computer Simulations

Using finite element analysis to identify component displacements, strains, and stresses under internal and external loads, Deakin University benchmarked the Studco Vortex system against other wall systems on the market.

This stimulation was based on a wall installation fixed to a concrete substrate with an undulating surface of +/- 3mm, significantly less than witnessed in the field.

This testing identified both extensive elastic and plastic deformation across the traditional system.

The images below display a large amount of tension and deformation in traditional steel sections. In contrast, the Studco Vortex section shows only a small amount of deformation around the designed for purpose pre-stressed fixing tabs.

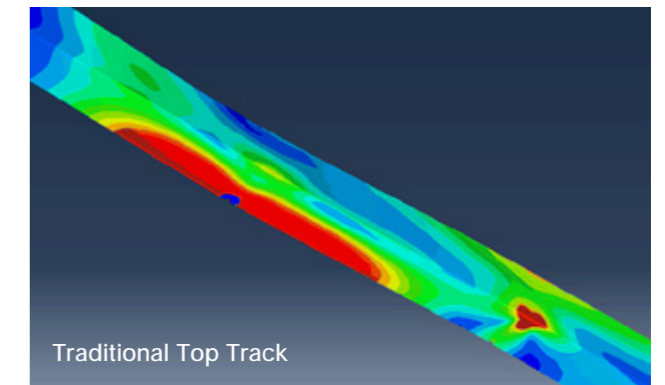
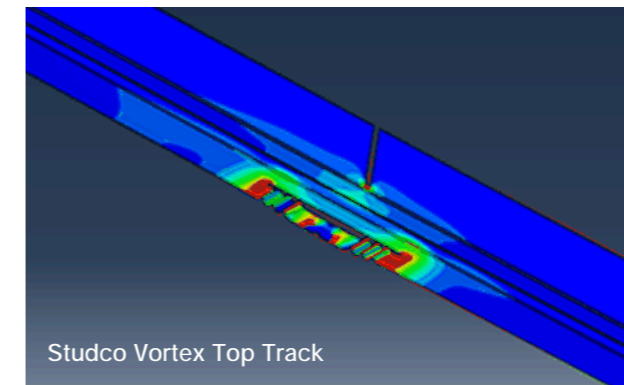

Structural Lab Testing

Verifying the results of the FEA process, Deakin University conducted structural testing of traditional wall systems against the Studco Vortex system. This displayed comparable results to the FEA as the traditional system displayed extreme deformation across the length of the metal profiles.

Results show the unyielding rigidity of the Studco Vortex Wall System stood out, when evaluating the two tested samples. This is important to modern high-rise buildings as deformation of the profile introduces stress into the system and increases the likelihood of generating noise and friction in the internal framing system.

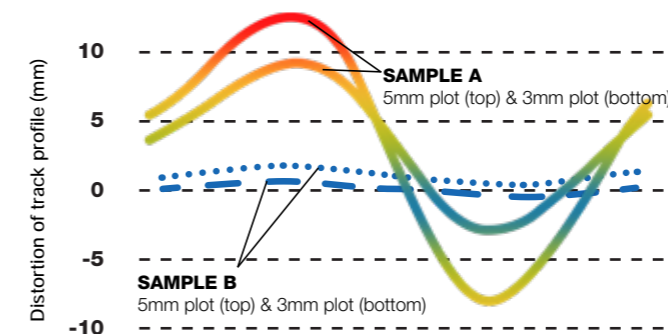

Sample A (Traditional)

Sample B (Vortex)

Results

Trial Installation

The Studco Vortex wall system underwent the ultimate test when it was installed in apartments within a 250 metre tall building which had known noise annoyance issues. Initially, sound recording devices were placed within the apartment for three months to capture the noises experienced within the living space. Then the existing walls were removed and replaced with the Studco Vortex wall system,

followed by a further three month period of recording the noises in the apartment. Using wind speed recorders placed on the building to align similar high wind events, the before and after results of the sound recordings were then compared, and demonstrated that Studco's new system had greatly improved the livability of the space.

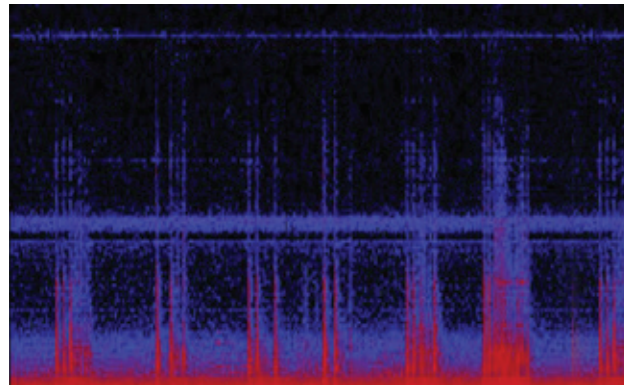

Audible creaking noise up to 58dB with walls constructed from a traditional wall system.

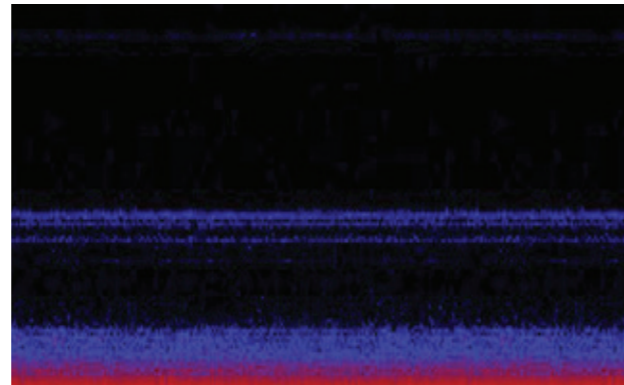

After walls were rebuilt from Studco Vortex wall system, only normal ambient noise is audible.



Studco Vortex System

64mm

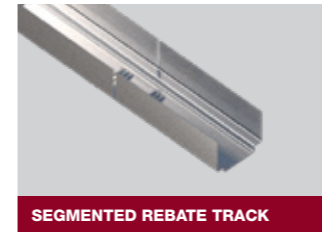

SEGMENTED REBATE TRACK

Part No.	SEGMENTED REBATE TRACK	Length mm	Sub Pack	Stock Pack
SRT6475-30	Studco Vortex 64 x 0.75 BMT rebate track	3000	10	100

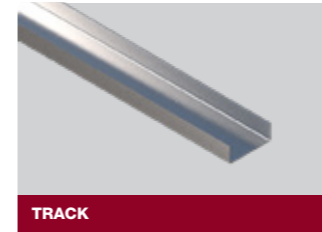

TRACK

Part No.	BOTTOM TRACK	Length mm	Sub Pack	Stock Pack
VT6450H-30	Studco 64 x 0.50 track 3.0m	3000	10	100
VT6475H-30	Studco 64 x 0.75 track 3.0m	3000	10	100
VT7675H-30	Studco 76 x 0.75 track 3.0m	3000	10	100



STEEL WALL STUD

Part No.	STEEL WALL STUD - 0.50 BMT	Length mm	Sub Pack	Stock Pack
S6450-24	Studco 64 x 0.50 BMT wall stud	2400	10	100
S6450-27	Studco 64 x 0.50 BMT wall stud	2700	10	100
S6450-275	Studco 64 x 0.50 BMT wall stud	2750	10	100
S6450-28	Studco 64 x 0.50 BMT wall stud	2800	10	100
S6450-30	Studco 64 x 0.50 BMT wall stud	3000	10	100
S6450-33	Studco 64 x 0.50 BMT wall stud	3300	10	100
S6450-36	Studco 64 x 0.50 BMT wall stud	3600	10	100
S6450-42	Studco 64 x 0.50 BMT wall stud	4200	10	100

Part No.	STEEL WALL STUD - 0.75 BMT	Length mm	Sub Pack	Stock Pack
S6475-24	Studco 64 x 0.75 BMT wall stud	2400	10	100
S6475-27	Studco 64 x 0.75 BMT wall stud	2700	10	100
S6475-30	Studco 64 x 0.75 BMT wall stud	3000	10	100
S6475-36	Studco 64 x 0.75 BMT wall stud	3600	10	100
S6475-42	Studco 64 x 0.75 BMT wall stud	4200	10	100
S6475-48	Studco 64 x 0.75 BMT wall stud	4800	10	100
S6475-60	Studco 64 x 0.75 BMT wall stud	6000	10	100

Studco Vortex System

92mm

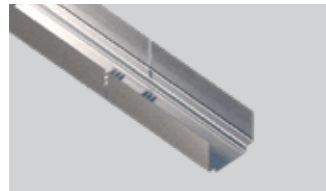

SEGMENTED REBATE TRACK

Part No.	SEGMENTED REBATE TRACK	Length mm	Sub Pack	Stock Pack
SRT9275-30	Studco Vortex 92 x 0.75 BMT rebate track	3000	10	100

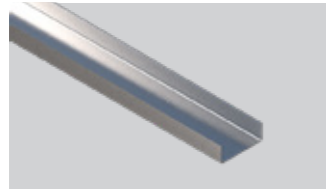

TRACK

Part No.	BOTTOM TRACK	Length mm	Sub Pack	Stock Pack
VT9255H-30	Studco 92 x 0.55 track 3.0m	3000	10	100
VT9275H-30	Studco 92 x 0.75 track 3.0m	3000	10	100

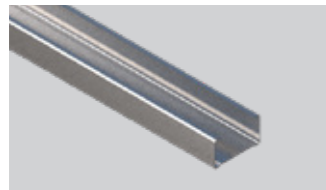

STEEL WALL STUD

Part No.	STEEL WALL STUD - 0.55 BMT	Length mm	Sub Pack	Stock Pack
S9255-24	Studco 92 x 0.55 BMT wall stud	2400	10	100
S9255-27	Studco 92 x 0.55 BMT wall stud	2700	10	100
S9255-275	Studco 92 x 0.55 BMT wall stud	2750	10	100
S9255-30	Studco 92 x 0.55 BMT wall stud	3000	10	100
S9255-33	Studco 92 x 0.55 BMT wall stud	3300	10	100
S9255-36	Studco 92 x 0.55 BMT wall stud	3600	10	100
S9255-42	Studco 92 x 0.55 BMT wall stud	4200	10	100
S9255-48	Studco 92 x 0.55 BMT wall stud	4800	10	100

Part No.	STEEL WALL STUD - 0.75 BMT	Length mm	Sub Pack	Stock Pack
S9275-24	Studco 92 x 0.75 BMT wall stud	2400	10	100
S9275-24	Studco 92 x 0.75 BMT wall stud	2700	10	100
S9275-30	Studco 92 x 0.75 BMT wall stud	3000	10	100
S9275-36	Studco 92 x 0.75 BMT wall stud	3600	10	100
S9275-42	Studco 92 x 0.75 BMT wall stud	4200	10	100
S9275-48	Studco 92 x 0.75 BMT wall stud	4800	10	100
S9275-60	Studco 92 x 0.75 BMT wall stud	6000	10	100

*76mm Vortex System also available on request.

All information provided and opinions expressed on this document are of a general nature only. You should seek your own specialist advice to ensure that the materials, approach, information and techniques referred to in this document meet your specific requirements before deciding whether Studco Australia Pty Ltd products, including the Vortex High-Performance Framing System, are suitable for you. Images are not to scale and examples only. Information contained on this document is current as at the date of publication. To the extent permitted by law, Studco Australia Pty Ltd disclaims all liability and responsibility for any loss or damage, direct or indirect, which may be suffered by any person acting in reliance on anything contained in or omitted from this document.

Studco Vortex System

Isolation Clips



M120

Part No.	ISOLATION CLIP	Stock Pack
M120	Studco Vortex Isolation Clip For Stud/track	100

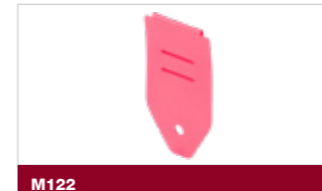

M122

Part No.	ISOLATION CLIP	Stock Pack
M122	Studco Vortex Premium Isolation Clip for Wall Studs	100



M132

Part No.	ISOLATION CLIP	Stock Pack
M132	Studco Vortex Isolation Clip For Jamb Stud	100



M133

Part No.	ISOLATION CLIP	Stock Pack
M133	Studco Vortex Isolation Clip For Nogging Track	100



M134

Part No.	ISOLATION CLIP	Stock Pack
M134	Studco Vortex Isolation Clip For Wall End	100



M135

Part No.	ISOLATION CLIP	Stock Pack
M135	Studco Vortex Isolation Clip For Beta-fix	100



M136

Part No.	ISOLATION CLIP	Stock Pack
M136	Studco Vortex Isolation Clip For M308 Furring Channel	100



M138

Part No.	ISOLATION CLIP	Stock Pack
M138	Studco Vortex Isolation Clip For Universal Furring Channel	100

Contact the team for pricing & samples

hello@mbsarchitectural.com.au | 03 9580 7800



MBS
Architectural

Every material. One source.

Reach out to our team for support, samples and advice.

03 9580 7800

hello@mbsarchitectural.com.au

VIC | 7 Haymer Court, Braeside 3195

QLD | 13 Pease Court, Bethania 4205

[@MBSarchitectural](#)