



# ELRA Group

We empower your drive solutions



**EMPOWERING IDEAS**  
SINCE 1978

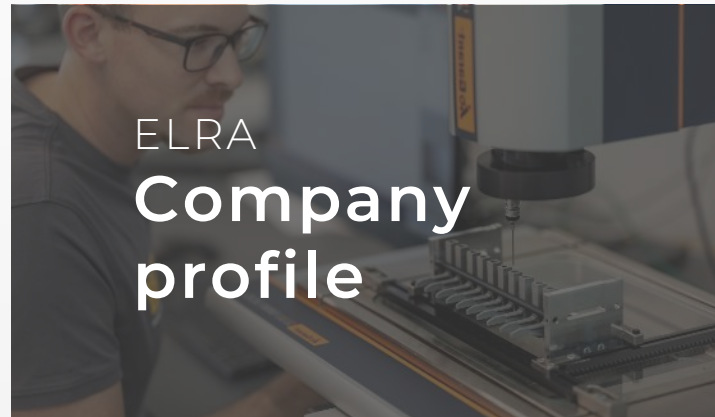

ELRA  
Company  
profile



# Corporate overview



**EMPOWERING IDEAS**  
SINCE 1978



**70**  
employees



headquarter: **Jois / Bgld**



**2.900 m<sup>2</sup>**  
production-warehouse area







founded in  
**1978**



**EUR 20,2 Mio.**  
(annual sales 2022)

## CERTIFICATES

-  Austrian model company
-  ISO 9001 : 2015
-  ISO 14001 : 2015
-  EN ISO 13485 : 2012



# Corporate overview



**EMPOWERING IDEAS**  
SINCE 1978

## Product development

- application-specific product development
- prototyping for product evaluation
- testing facilities for product tests
- creation of complete manufacturing documentation and testing on CAD workstations



# Corporate overview



**EMPOWERING IDEAS**  
SINCE 1978

## Production

- series production of special and standard solutions
- in house prototyping with modern machinery
- standard industrial assembly
- precision mechanics assembly with ESD-compliant workstations

## Error Rate

of production of ELRA  
in 2021 is as low as

**0,03 %**

**90 %**

in-house  
production



## Quality management

- extensive performance and durability tests
- continuous measurement of customer satisfaction
- Inspection of incoming goods and final production control
- ELRA Quality Warranty also for Assemblies

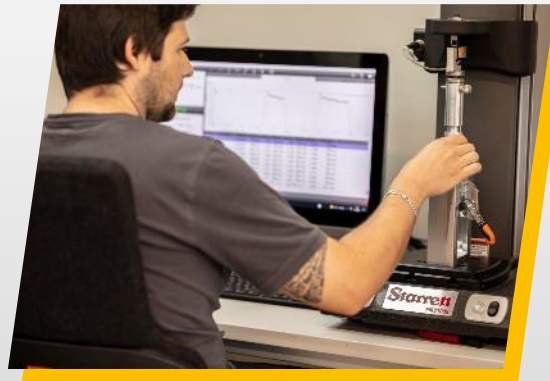

# ELRA Group

We empower your drive solutions



**EMPOWERING IDEAS**  
SINCE 1978

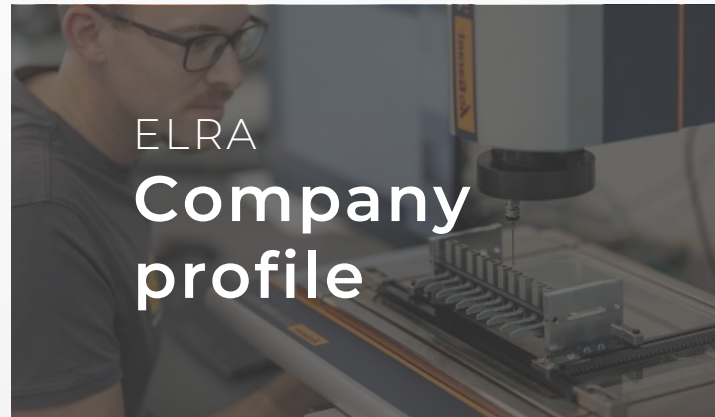

ELRA  
**Assemblies**



# Assemblies



**EMPOWERING IDEAS**  
SINCE 1978

Efficiency taken one step further

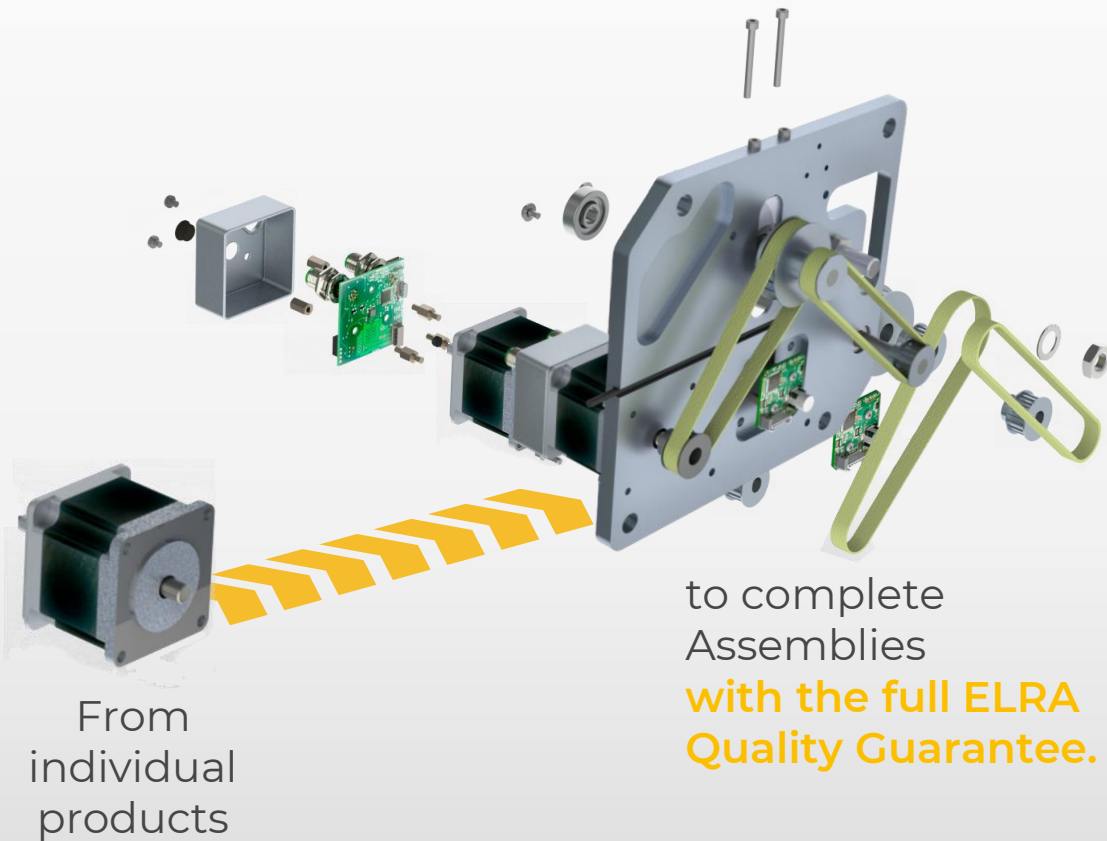

Our experts work out tailor-made solutions and transfer these into functional assemblies.

- ✓ Design
- ✓ Development
- ✓ Procurement
- ✓ Assembly
- ✓ Final quality inspection
- ✓ Delivery

# ELRA Group

We empower your drive solutions



**EMPOWERING IDEAS**  
SINCE 1978



ELRA  
Products

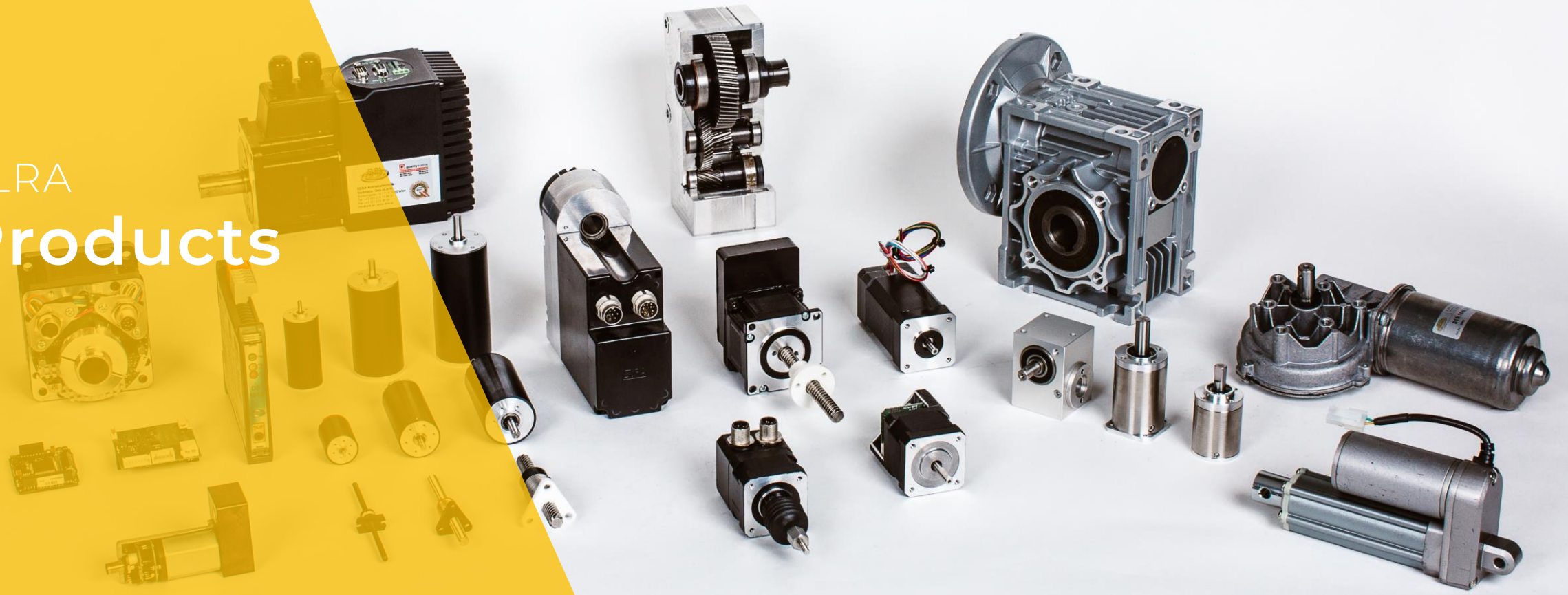

# Products



**EMPOWERING IDEAS**  
SINCE 1978

## Solutions for various industries

DC-motors & gearmotors



Brushless motors



Steppermotors



AC-motors



Gearheads



Linear actuators



Speed- and  
Motion controller



complete drives for  
your application

# Products

DC-motors & gearmotors



- High precision dc-motors
- Low-cost motors
- Standard dc-motors
- DC-wormgarmotors

## FACTBOX

SIZE	16 – 90 mm
POWER	up to 300W
VOLTAGE	3 – 60 V

# ELRA

EMPOWERING IDEAS  
SINCE 1978



# Products

## Brushless motors



- Brushless precision drives
- Brushless standard dc-servomotors
- Brushless dc-motors with integrated electronics

### FACTBOX

SIZE	12 – 90 mm
POWER	up to 800W
VOLTAGE	3 – 60 VDC



**EMPOWERING IDEAS**  
SINCE 1978



# Products

## Steppermotors



- Standard 2-phase steppermotors
- Steppermotors with integrated controller
- Step angle 0,9° | 1,8° | 15° | 18°
- Industrial version with up to IP65 possible

### FACTBOX

SIZE	15 – 110 mm
HOLDING TORQUE	Up to 28Nm

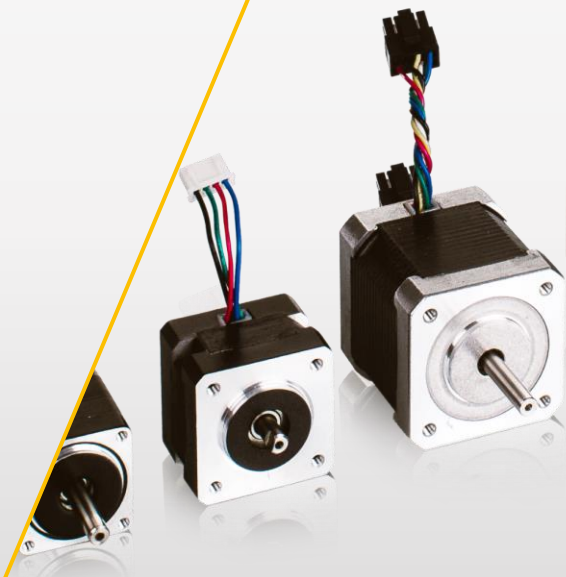

# ELRA

EMPOWERING IDEAS  
SINCE 1978

# Products

## AC-motors

- Synchronous ac-motors with gearboxes
- Asynchronous ac-motors with gearboxes
- IEC-motors



### FACTBOX

SIZE	42 – 160 mm
POWER	Up to 1,5kW
VOLTAGE	24 – 400 VAC / 50 – 60Hz

# ELRA

EMPOWERING IDEAS  
SINCE 1978



# Products



**EMPOWERING IDEAS**  
SINCE 1978

## Gearheads

- Precision gearheads
- Standard planetary gearheads
- Low-backlash planetary gearheads
- Wormgearbox
- helical gearboxes



### FACTBOX

SIZE	12 – 120 mm
TORQUE	Up to 350Nm
BACKLASH	Up to 3arc min

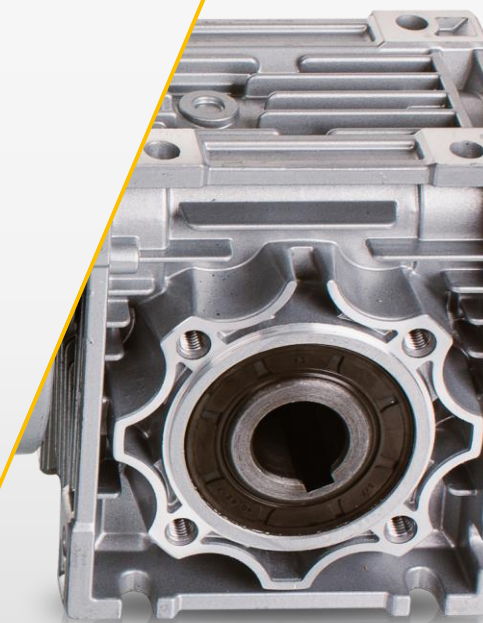

# Products

## Linear actuators

- Linear actuators with screw and DC- or Stepper motor
- Linear spindles and spindle nuts
- Stroke length up to 1.000mm

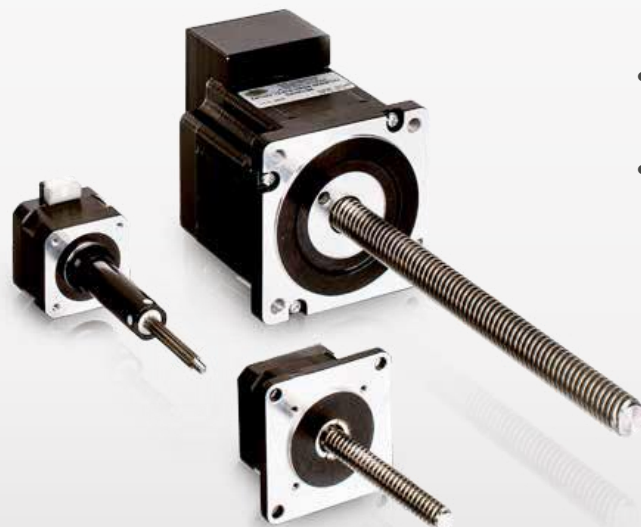

# ELRA

EMPOWERING IDEAS  
SINCE 1978

FACTBOX

POWER Up to 7000N  
VOLTAGE 12 – 60V



# Products

## Speed- and Motion controller



- Speed controller for brushed dc-motors
- Speed controller for brushless dc-motors
- Motion-controller for brushed or brushless dc-motors
- Steppermotor driver and controller for 2-phase steppermotors

**FACTBOX**

POWER Up to 1,8kW  
VOLTAGE 6 – 90V

**ELRA**

EMPOWERING IDEAS  
SINCE 1978

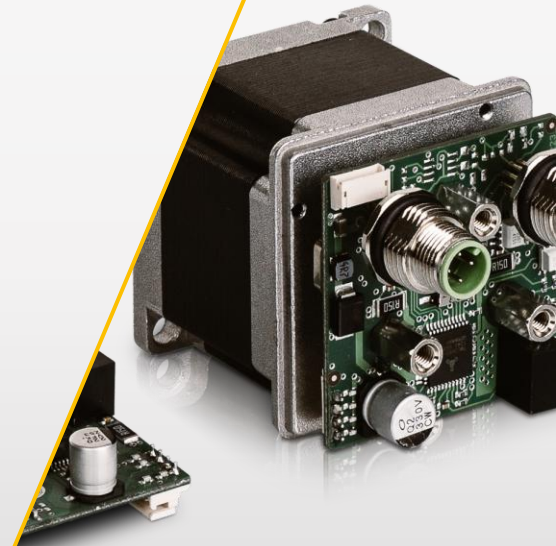

# Products

## Complete Drives

**ELRA**

EMPOWERING IDEAS  
SINCE 1978

- Proven and adaptable drive solutions
- Short delivery times
- Different designs
- Various motor and gearbox combinations



**FACTBOX**

POWER	bis 220W
VOLTAGE	24VDC   48VDC
PROTECTION	IP65 up to IP69



# ELRA Group

We empower your drive solutions



**EMPOWERING IDEAS**  
SINCE 1978

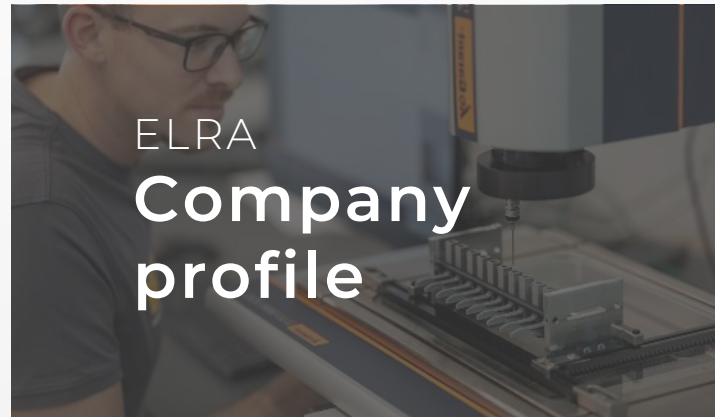

# ELRA Applications

PLEASE CHOOSE YOUR ELRA ENDUSE APPLICATION



# Applications



**EMPOWERING IDEAS**  
SINCE 1978

Various Markets, but always an ELRA Solution

**Agricultural engineering**



**Heating technology**



**Food processing technology**



**Machine engineering**



**Warehouse**



**Instrument engineering**



**Medical & laboratory devices**



**Semiconductor industry**



**Optical & Video**



**Building automation**



# Applications

Agricultural engineering



**EMPOWERING IDEAS**  
SINCE 1978

Product:

**Seed spreader / Salt spreader**

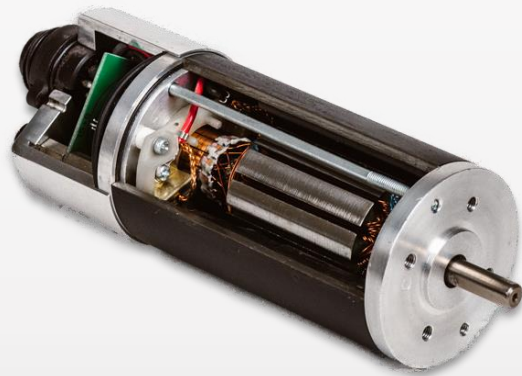

**Requirement:**

- Reliable, robust drive
- Durable
- Protected against splash water
- Protected against vibrations



# Applications

Heating technology

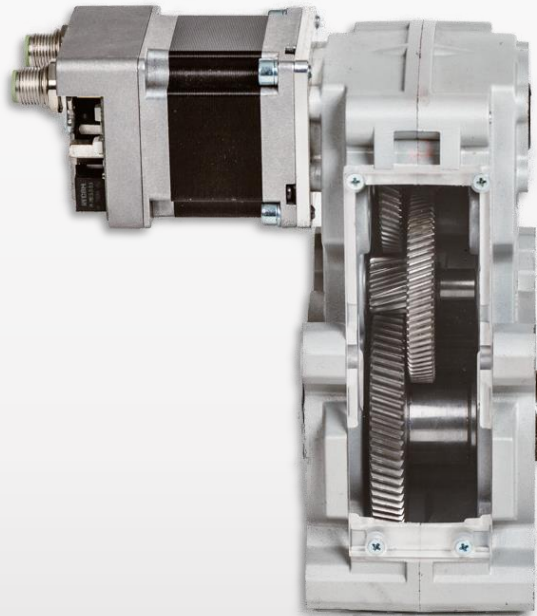

Product:

## Drive for pellet transportation

### Requirements:

- Energy efficiency
- Integrated electronics
- Durable spur-wheel gearhead
- Resistant against high temperature

# ELRA

EMPOWERING IDEAS  
SINCE 1978



# Applications

Food processing technology



**EMPOWERING IDEAS**  
SINCE 1978

Product:  
**Drive for conveyer belt**

## Requirements:

- Compact size (flat)
- Integrated electronics
- Integrated planetary gearbox
- Food-safe lubricants



# Applications

Machine engineering



EMPOWERING IDEAS  
SINCE 1978

Product:

## Drive for profile adjustment

### Requirements:

- Compact overall design
- Special solution
- Integrated electronics
- Durable spur-wheel gearhead

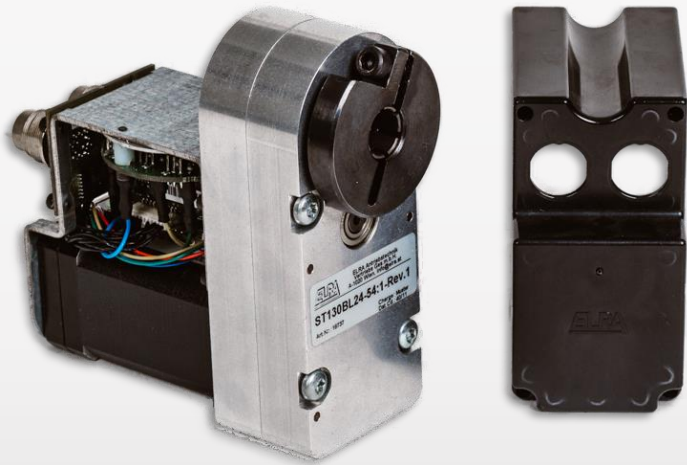

# Applications

Warehouse automation

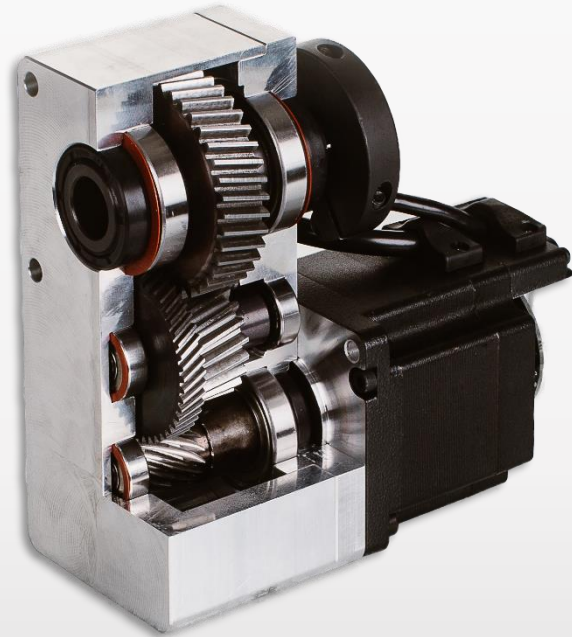

Product:

## Main drive for shuttle

### Requirements:

- Durable, long-lasting drive
- Compact dimensions
- Robust gearhead
- Integrated encoder

# ELRA

EMPOWERING IDEAS  
SINCE 1978



# Applications

Instrument engineering



**EMPOWERING IDEAS**  
SINCE 1978

Product:

**Adjustment drive for hardness tester**

## Requirements:

- Compact design
- Integrated encoder
- Special housing
- Industrial connector



# Applications

Medical & Laboratory devices

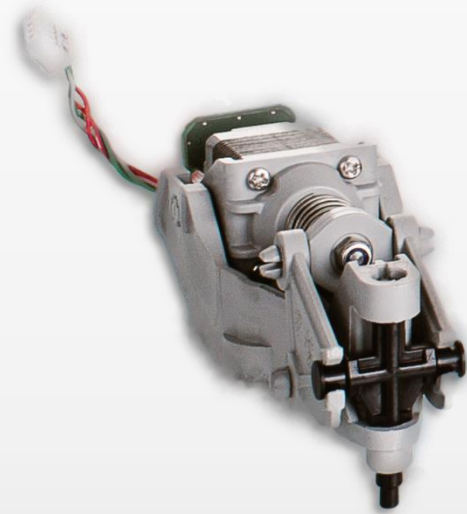

Product:

## Assembly group for blood analyzer

### Requirements:

- Precise positioning
- Compact size
- Integrated encoder
- Assembly at ELRA factory



**EMPOWERING IDEAS**  
SINCE 1978



# Applications

Semiconductor industry



EMPOWERING IDEAS  
SINCE 1978

Product:

## Hollow shaft stepper motor with integrated electronics

### Requirements:

- Stepper motor with hollow shaft
- Integrated drive electronics
- Limit-switch detection with optical feedback
- Integrated encoder

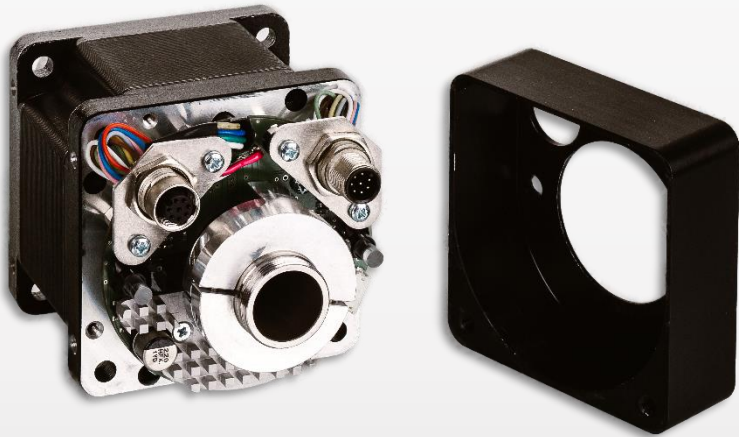

# Applications

Optical & Video



**EMPOWERING IDEAS**  
SINCE 1978

Product:

## Linear actuator for hexapod camera system

### Requirements:

- Linear actuator with Stepper motor
- Integrated limit-switch
- Captive shaft
- Integrated ball joint

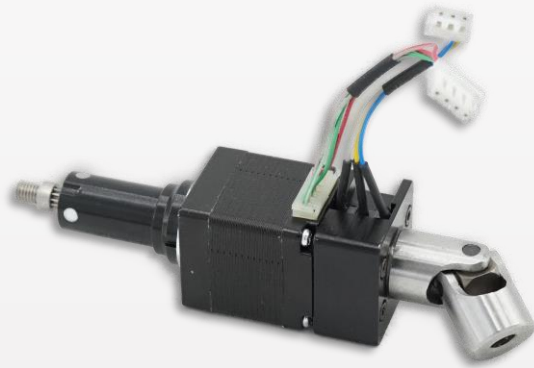

# Applications

Building automation



Product:

## Linear drive for sun protection

### Requirements:

- Slim dimensions (cylindrical)
- Integrated Electronics for motion control
- High protection class for outside usage
- Cable assembly

# ELRA

EMPOWERING IDEAS  
SINCE 1978

# ELRA Group

We empower your drive solutions



**EMPOWERING IDEAS**  
SINCE 1978

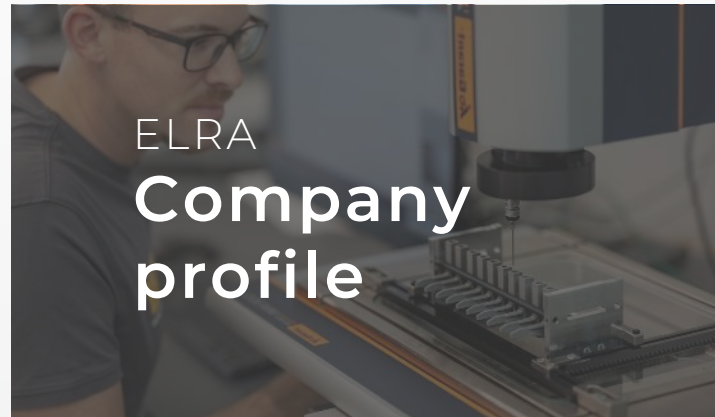

Proven  
Reliability



**EMPOWERING IDEAS**  
SINCE 1978

For almost  
40 years our  
customers rely  
upon our strong  
quality promise.

