



COREX DT

User Manual

TABLE OF CONTENTS

- | | |
|----|---|
| 01 | Acknowledgments
Appreciation and warm welcome to the BAT family. |
| 03 | What's in the Box?
A quick overview of all items included in the package. |
| 04 | Key Features
Highlights of the main functions and benefits. |
| 05 | Specs Sheet
Detailed technical specifications of the product. |
| 07 | Dimensions
Physical measurements and size details. |
| 08 | Front Panel
Overview of buttons, indicators, and controls on the device's front. |
| 09 | Rear Panel
Overview of ports and controls on the back of the device. |
| 10 | Software Guide
Overview of the system interface, settings, and software features. |
| 61 | Connection Guide
Visual guide for wiring and setup connections. |
| 62 | Hazard/Warning Note
Important safety cautions and potential risks. |
| 63 | Warranty/Disclaimer
Coverage terms and conditions for product support. |

Acknowledgments

EN

Thank you for choosing BAT.

Your trust in our commitment to sonic precision and purposeful design means the world to us. Each BAT product is the result of rigorous engineering, careful craftsmanship, and a relentless pursuit of acoustic clarity. We hope it brings richness and reliability to every sound you experience. Welcome to the BAT family.

FR

Merci d'avoir choisi BAT.

Votre confiance en notre engagement envers la précision sonore et le design réfléchi nous touche profondément. Chaque produit BAT est le fruit d'une ingénierie rigoureuse, d'un artisanat soigné et d'une quête incessante de clarté acoustique. Nous espérons qu'il apportera richesse et fiabilité à chaque son que vous vivrez. Bienvenue dans la famille BAT.

DE

Vielen Dank, dass Sie sich für BAT entschieden haben.

Ihr Vertrauen in unser Engagement für klangliche Präzision und durchdachtes Design bedeutet uns sehr viel. Jedes BAT-Produkt ist das Ergebnis rigoroser Ingenieurskunst, sorgfältiger Handwerkskunst und eines unermüdlichen Strebens nach akustischer Klarheit. Wir hoffen, dass es jedem Ihrer Klangerlebnisse Reichtum und Zuverlässigkeit verleiht. Willkommen in der BAT-Familie.

IT

Grazie per aver scelto BAT.

La sua fiducia nel nostro impegno per la precisione sonora e il design mirato è per noi di grande valore. Ogni prodotto BAT è il risultato di un'ingegneria rigorosa, di una lavorazione artigianale accurata e di una costante ricerca della chiarezza acustica. Ci auguriamo che porti ricchezza e affidabilità a ogni suono che ascolta. Benvenuto nella famiglia BAT.

JP

BAT をお選びいただきありがとうございます。

音の精度と意図的なデザインへの私たちの取り組みに対するあなたの信頼は、私たちにとって非常に重要です。BAT の各製品は、厳密なエンジニアリング、丁寧なクラフトマンシップ、そして音響の明瞭さへの絶え間ない追求の成果です。

それがあなたのすべての音の体験に豊かさや信頼性をもたらすことを願っています。BAT ファミリーへようこそ。

AR

شكرًا لاختيارك BAT.

إن ثقتك في التزامنا بالدقة الصوتية والتصميم المدروس تعني لنا الكثير. كل منتج من BAT هو نتيجة لهندسة دقيقة، وحرفية متقنة، وسعي لا يكل لتحقيق وضوح صوتي فائق. نأمل أن يضيف هذا المنتج ثراءً وموثوقية لكل تجربة استماع تخوضها. مرحبًا بك في عائلة BAT.

Acknowledgments

SP

Gracias por elegir BAT.

Su confianza en nuestro compromiso con la precisión sonora y el diseño intencionado significa mucho para nosotros. Cada producto de BAT es el resultado de una ingeniería rigurosa, una artesanía cuidadosa y una búsqueda incansable de claridad acústica. esperamos que aporte riqueza y fiabilidad a cada sonido que experimente. Bienvenido a la familia BAT.

RU

Благодарим вас за выбор BAT.

Ваше доверие к нашему стремлению к звуковой точности и продуманному дизайну очень важно для нас. Каждый продукт BAT результат строгой инженерии, тщательного мастерства и неустанного стремления к акустической ясности.

Мы надеемся, что он принесет богатство и надежность в каждое ваше звуковое впечатление. Добро пожаловать в семью BAT.

CN

感谢您 BAT。

您我在声音精度和有目的方面承的信任我意重大。每一款 BAT 品都是工程、精心工和音响清晰度不懈追求的晶。

我希望它能您的每一次聆听体来丰富和可靠。迎加入 BAT 大家庭。

PT

Obrigado por escolher a BAT.

A sua confiança no nosso compromisso com a precisão sonora e o design intencional significa muito para nós. Cada produto BAT é o resultado de engenharia rigorosa, artesanato cuidadoso e uma busca incessante pela clareza acústica.

Esperamos que ele traga riqueza e confiabilidade a cada som que você experimente. Bem-vindo à família BAT.

TR

BAT'ı seçtiğiniz için teşekkür ederiz.

Ses hassasiyeti ve amaçlı tasarıma olan bağlılığımıza duyduğunuz güven bizim için çok değerlidir. Her BAT ürünü, titiz mühendislik, özenli işçilik ve akustik netliğe yönelik amansız bir arayışın sonucudur.

Bu ürünün, yaşadığınız her ses deneyimine zenginlik ve güvenilirlik katmasını umuyoruz. BAT ailesine hoş geldiniz.

HI

BAT चुनने के लिए धन्यवाद।

ध्वनि की सटीकता और उद्देश्यपूर्ण डिज़ाइन के प्रति हमारी प्रतिबद्धता में आपके विश्वास का हमारे लिए बहुत महत्व है। प्रत्येक BAT उत्पाद कठोर इंजीनियरिंग, सावधानीपूर्वक शिल्प कौशल और ध्वनिक स्पष्टता की निरंतर खोज का परिणाम है।

हमें आशा है कि यह आपके हर श्रवण अनुभव में समृद्धि और विश्वसनीयता लाएगा। BAT परिवार में आपका स्वागत है।

What's in the Box?



User Manual



Your BAT COREX DT



Power Cable

Key Features

COREX DT Series

The Future of Audio Processing and Control.

The **COREX DT** is a versatile Digital Audio Processor designed for comprehensive audio signal management. It features extensive input/output capabilities, including balanced microphone/line inputs and balanced audio outputs, alongside network audio integration through DANTE input and output. Equipped with custom operating software, it offers flexible configuration and control over various DSP functionalities. The processor incorporates advanced audio processing modules such as AFC (feedback suppression), AEC (echo cancellation), ANS (noise suppression), AGC (automatic gain), and gain-sharing automatic mixing. With a built-in USB sound card, it supports audio signal transmission for recording and remote conferencing. Available in two configurations, **COREX 8DT** and **COREX 16DT**, the series supports 8×8 and 16×16 analogue I/O configurations to suit projects of any size. It provides end-user interfaces for centralized control, including third-party equipment integration via UDP, RS232, and RS485.

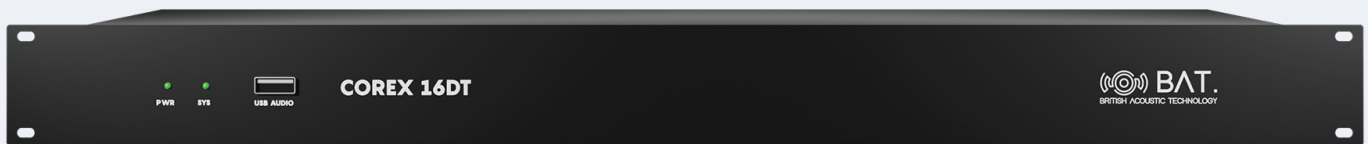

Advanced Audio, Automatic Perfection.

The **COREX DT** series delivers professional-grade audio with advanced DSP features including AFC (automatic feedback suppression), AEC (echo cancellation), ANS (noise suppression), AGC (automatic gain control), and gain-sharing automatic mixing. Each unit is powered by an ADI-architecture processor with a 40-bit floating-point DSP engine, providing robust flexibility in software configuration. The system ensures precise channel processing with independent adaptive feedback suppression for each input, enabling clean, uninterrupted audio performance.

Control Everything, Anywhere.

For integration and control, the **COREX DT** series offers flexible routing with a 20×17 or 36×33 audio matrix, full-featured matrix mixing, adjustable input levels, and seamless network audio via 8 or 16 way DANTE inputs and outputs. Connectivity is enhanced with a built-in USB sound card for computer interfacing, supporting audio transmission for recording and remote conferencing. The system provides extensive control options, including web, mobile, and touch panel interfaces, as well as centralized management through UDP, RS232, and RS485. Additional features include eight configurable GPIOs, 16 independent preset groups, and fire linkage support for enhanced safety coordination.

Specs Sheet

Unit	COREX 8DT	COREX 16DT
Analog Inputs:	8	16
Analog Outputs:	8	16
Analog Connectors:	Phoenix plug interface	
DANTE Inputs:	8-way DANTE	16-way DANTE
DANTE Outputs:	8-way DANTE	16-way DANTE
DANTE Connectors:	RJ45 network interface (2 dedicated interfaces)	
Custom Operating Software:	Yes, for flexible configuration and DSP control	
USB Sound Card:	Built-in, for audio transmission, recording, conferencing	
Control Interfaces:	UDP, RS232, RS485 (user-definable UDP port)	
Feedback Suppression (AFC):	Yes, per channel adaptive	
Echo Cancellation (AEC):	Yes	
Noise Suppression (ANS):	Yes	
Automatic Gain Control (AGC):	Yes	
Automatic Mixing:	Gain-sharing threshold	
Matrix Size:	20x17	
Presets:	16 groups, independent operation	
GPIO:	8 (configurable, inputs usable as ADC)	

Specs Sheet

Unit	COREX 8DT	COREX 16DT
Channel Functions:	Bay, LINK, Grouping	
Processor Architecture:	ADI	
DSP Engine:	40bit floating-point computing engine	
Fire Linkage:	Yes	
Control Modes:	Web, mobile, tablet, key panel, touch panel 113dB	
Analog/Digital Dynamic Range (A-weighted):	113dB	
Digital/Analog Dynamic Range (A-weighted):	115dB	
Input Gain:	0/10/20/30/40/43dB	
Output Level:	0/6dB	
Sampling Rate:	48kHz	
Input Processing (per channel):	8-band PEQ, AFC, AEC, ANS, AGC, Autor Mixer	
Output Processing (per channel):	Crossover, 8-band PEQ, Delay, Limiter	
Frequency Response:	20-20kHz (± 0.2 dB)	
Common Mode Rejection:	@60Hz 80dBu	
Maximum Level:	+24dBu	

Specs Sheet

Unit	COREX DT8	COREX DT16
Total Harmonic Distortion:	≤0.003% @1KHz,+4dBu	
Noise Floor (A-Weighted - Analog):	-89dBu	
Noise Floor (A-Weighted - Dante):	N/C (Not Compatible / Not Applicable)	
Other Interfaces:	GPIO (8), RS232/RS485 (I), RJ45 (1 control), USB (I)	
Input Impedance (Balanced)	9.4KΩ	
Input Impedance: (Balanc Connection):	102Ω (This appears to be a separate specification or a typo, as 9.4kOhm is also listed)	
Phantom Power:	48V	
Power Requirements:	AC110V-240V, 50Hz/60Hz	

Dimensions

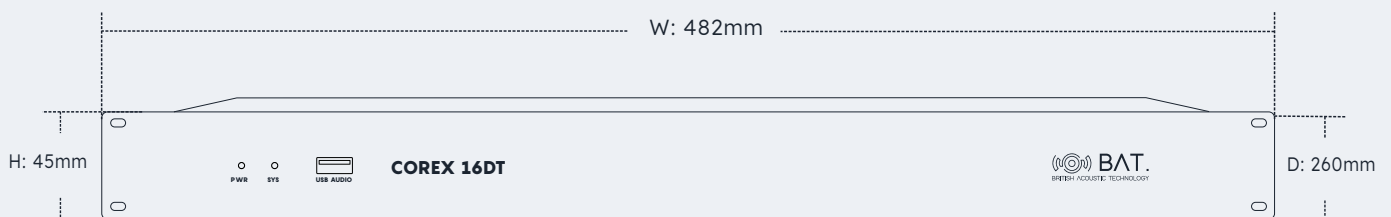

Front Panel



- 1. Power:**
LED power indicator.
- 2. Status:**
Device operation status indicator.
- 3. Usb Audio:**
USB sound card for recording and broadcasting.
- 4. Rack Mounting Holes:**
For secure installation in a standard equipment rack.

Rear Panel

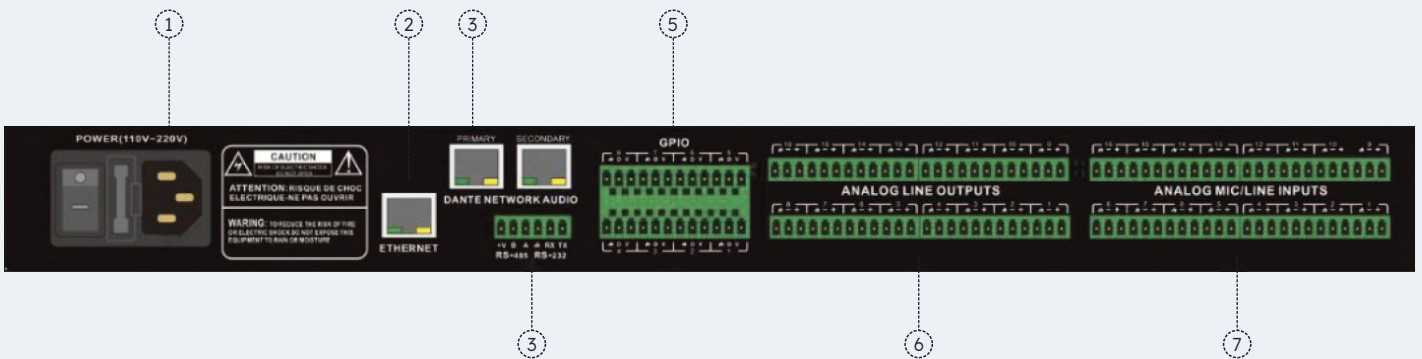

1. Power Connector:

Connects to 110V-220V AC power supply, and the power supply of the processor is controlled by a rocker switch.

2. ETHERNET Network Control Interface:

By connecting this network interface, the client computer can debug and monitor the equipment.

3. Dante Network Interface:

Used to connect to a Dante audio network.

4. RS232+RS485 Interface: Connect to control terminal or center control equipment.

5. GPIO Interface:

8 Logic outputs with 4 pairs of general-purpose ground pins. Logic outputs go low (0V) when activated, and pull high internally when not activated. (5V) to directly illuminate external LEDs. Logic outputs can be driven by the logic output control module in the device design. Polarity and thresholds can be set in software.

6. OUTPUT Analog Signal Output Interface:

It can be connected to amplifier, active speakers and other devices.

7. INPUT Analog Signal Input Connector:

You can connect microphone, DVD and other devices.

Software Guide

1. Software Installation

A Windows PC with a 1 GHz or higher processor and: Windows 7 or higher.
1 GB free storage space.
1024 x 768 resolution.
24-bit or higher color.
2GB or more memory.
Network (Ethernet) interface.
CAT5 cable or existing Ethernet network.

Audio processor built-in control software, no need to install the CD-ROM, access to the audio processor IP address can be quickly downloaded, by entering the device IP address in the browser address bar to access the audio processor, to find the download link to download the installation software to complete the installation locally. The factory default IP address of the device is: 169.254.10.227 Subnet Mask: 255.255.0.0, please add the address of this network segment in your PC first, so that the device can be accessed normally, after the device has finished booting up, enter "http://169.254.10.227/" in the address bar of your browser.

Before installing the software on the PC, make sure that Microsoft. Net Framework 4.0 or later is installed on the PC.

Note: If you fail to download or install the software, please try using Internet Explorer or Google Chrome, or enter your browser settings to cancel the download pop-up box and try again.

2. Using The Software

After opening the software, the main interface is displayed:



Software Guide

Click the upper right corner of the main interface button on the right corner of the main interface, it will automatically find all the processors on the network, and users can connect to the specified processor according to their needs, and this picture of the device list will be lit up after connecting. A processor supports up to 8 users to connect and control online at the same time.

3.Module Parameters (Audio Module Parameters)

There are two ways to adjust the module parameters, one is to directly click on the input or output channel module to enter the parameter interface of the module; the second is to right-click on the module to bring up the configuration interface of the module. The following module parameters are all described in the first way.

3.1. Input Source

Sensitivity: Microphone Gain, 0/10/20/30/40dB 5 stops selectable.

Phantom Power: Feeds an external condenser microphone, click this button when needed. Do not turn it on for line inputs or without power to prevent damage to external devices.

Sine Wave: Drag the frequency to generate a sine wave at the specified frequency (20~20kHz). The output level can be adjusted as desired in dBFS. use the fader to adjust or click the text input box to specify a value.

White Noise: White noise has equal energy on each frequency component. It has a flat spectrum when viewed on a constant bandwidth spectrometer. At this point the frequency adjustment is not valid and the level is available.

Pink Noise: The frequency component power of pink noise is mainly distributed in the middle and low frequency bands, and it decreases at a rate of 3dB/Oct in the frequency spectrum. At this time, the frequency adjustment is invalid and the level is available.

In addition, right clicking on each fader in the main screen reveals the following menu settings.

Copy: Copy all the parameters of this channel to another channel.

Group Setup: Quickly opens the Group Setup screen.

Minimum Gain and Maximum Gain: Limit the maximum and minimum values of the gain of this channel. When after debugging, you don't want the stability of the system to be affected by external changes, you can set the maximum gain.

Software Guide

3.2 .Expander

An expander is in principle the opposite of a compressor in that it extends the dynamic range of a signal. The most basic difference between the two devices is that the compressor works on signals above the threshold, while the expander works on signals below the threshold. The expander is able to make small signals smaller, as can be seen in Figure 3.2, where an input signal 20dB below the threshold produces an output signal 40dB below the threshold the expansion ratio is 1:2. From what is shown on the graph, the portion of the signal below the threshold stretches downward, resulting in a smaller level. When using a 1:20 expansion ratio, the transmission characteristics of the expander look like a noise gate. In fact, a noise gate is an expander that uses a very large expansion ratio.

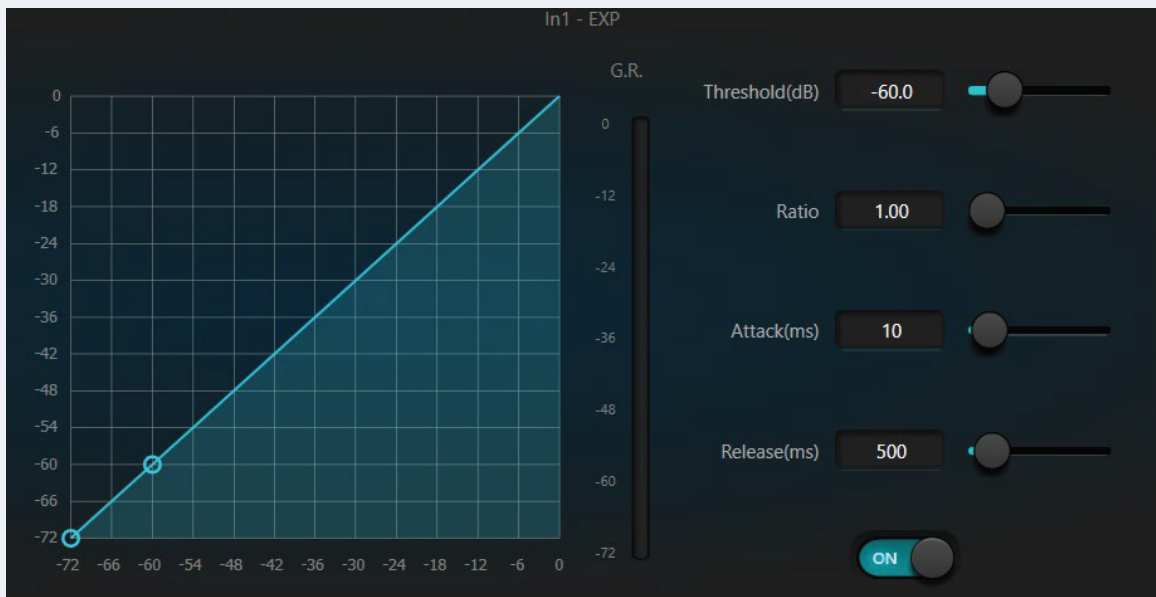

The expander has the following control parameters:

Threshold: The signal must exceed this level to turn on the expander (allow the signal to pass through). In practice it is usually set to the amount of ambient noise.

Ratio: The slope below the threshold point on the gain curve. A high ratio setting starts the proximity gate action.

Startup Time: The duration of the input signal, above the threshold, required to turn on the expander. Faster turn-on times allow faster transient turn-on of the expander.

Release Time: The time it takes for the gain to return to a value below the threshold after the input signal drops below the threshold.

Software Guide

The effect of either the build time or the release time is simply to reduce the rate of change in the amount of gain decay. That is, the rate at which the gain increases from -40dB to 0dB is slowed by the build time, and conversely the rate at which the gain decays from 0dB to -40dB is slowed by the release time. The build-up time, or the release time, is independent of the Threshold setting. If the signal varies in height below the Threshold, the Build Time and Release Time will also affect the amount of gain attenuation respectively, whereas once the signal level rises above the Threshold, the gain attenuation produced by the Expander will be hourly at the rate controlled by the Build Time. Once the signal level rises above the threshold, the gain reduction generated by the expander increases at a rate controlled by the build-up time. the gain reduction reaches 0dB, the expander stops expanding. Subsequently, when the signal drops below the threshold again, the expander starts up again and the build-up time kicks in.

3.3. Compressor Limiters (Compressor Limiters)

Compressor

The compressor reduces the dynamic range of signals above a user-set threshold, and the level of signals below that threshold remains unchanged. The compressor has the following control parameters:



Threshold:

The compressor/limiter starts to reduce the gain when the signal level is above this value. Any signal that exceeds the threshold is considered an overshoot signal and its level is reduced under normal circumstances. The more the signal exceeds the threshold, the more the level is attenuated.

Software Guide

Ratio:

i.e. compression ratio. The ratio determines how much the overshoot signal decays toward the threshold level. The smaller the compression ratio, the easier it is for the signal to go higher than the threshold. Once the signal exceeds the Threshold, the Compression Ratio parameter determines the ratio of the amount of change in the Input signal to the amount of change in the Output signal. For example, when the compression ratio is 2:1, if the input signal exceeds the threshold by 2dB, the output signal exceeds the threshold by only 1dB. a compression ratio of 1:1 means that the compressor does not attenuate the signal proportionally. The adjustable range of compression ratio is 1-20.

Start-up time, release time:

In order to preserve the natural feel of the start-up, it is often desirable that a portion of the initial level passes through the compressor unimpeded. (or only slightly affected). To accomplish this, the response time of the compressor needs to be made slower. Similarly, if there is a very large and rapid decay of the signal gain, as well as a rapid recovery, a pumping effect can occur. The build-up time and release time of the compressor are designed to avoid this. The build-up time can determine how fast the gain decay occurs, and the release time can determine how fast the gain recovers.

Output Gain:

Also called a gain compensation fader. If the compressor significantly reduces the level of the signal, it may be necessary to boost the output gain to maintain the volume level. This boost operation gives the same amount of boost to all parts of the signal, independent of the settings of the other parameters of the compressor. G.R. and output level meter: G.R. indicates the amount of compression of the compressor; output indicates the output level of the signal passing through the compressor module. The amount of compression is displayed as an inverted level meter. If the input signal is -6dB, the threshold is set to -30dB, and the ratio is 2:1, then the amount of compression is 12dB, the G.R. level meter indicates at the -12dB position, and the output indicates at the -18dB position.

Limiter

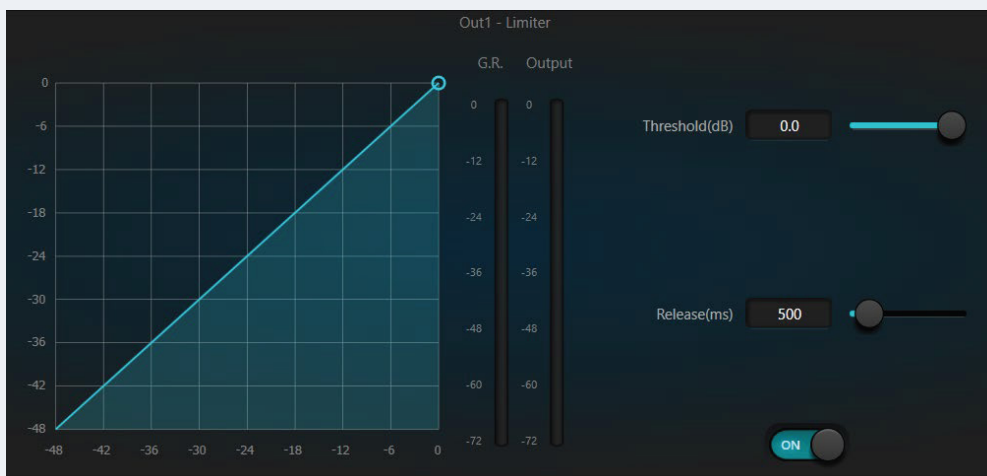

Software Guide

Also called a limiter, it has only one key task: to make sure that the signal does not exceed the threshold level, no matter what the situation. By adjusting the control parameters of a compressor, it can be made to work in a very similar way to a limiter. The core of how a limiter works is that it really relates to the content of the signal below the threshold level and how the amount of gain attenuation starts to be generated before the signal overshoots. The limiting period is handled accordingly through two processing stages, in the first stage only a relatively slight limiting is performed but the overshoot signal is not handled, then in the second stage if the signals produce an overshoot they decay in a very drastic way.

The limiter provides only two parameters, **the threshold** and **the release time**. For signal processing, occasional clipping should be addressed by the limiter, while frequent clipping usually requires attenuation of the signal level.

3.4. Automatic Gain (Auto Gain Control)

Automatic Gain Control (AGC) is a special case of a compressor with its threshold set at a very low level, medium to slow build-up time, long release time, and low ratio. Its purpose is to raise a signal of uncertain level to a target level while maintaining dynamics. Most automatic gain controls include some sort of silence detection to prevent loss of gain decay during silence. This is the only feature that distinguishes an automatic gain control from a normal compressor/limiter.

Normalize the level of a CD player playing background, foreground, or waiting music using automatic gain control to eliminate some variations in paging microphone levels.

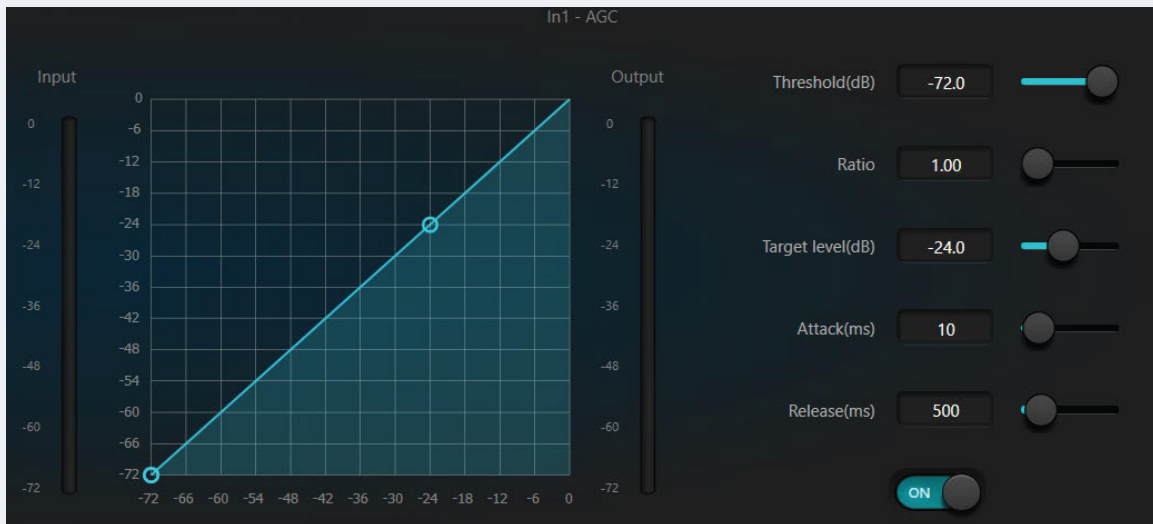

Software Guide

The automatic gain control contains the following controls and switches:

Threshold: When the signal level is below this threshold, the input/output ratio is 1:1. When the signal level is above this threshold, the input/output ratio varies with the Ratio Control setting. Set this threshold to the noise floor just above the input signal level.

Ratio: The ratio between the change in input signal level above the threshold and the change in output signal level.

Target Threshold: The desired output signal level. If the signal is above this threshold, the controller will compress the signal according to the ratio.

Startup Time: Controls the response time above a threshold level.

Release Time: Controls the level response time for signals below the threshold.

3.5. Equalizers

The main purpose of an equalizer is to correct over-emphasized or missing frequency ranges, whether they are wide or narrow. In addition, equalizers can help us narrow or widen frequency ranges, or change the size of certain components of their spectrum. In simple terms, equalizers can change the timbre of a signal.

The equalizer has the following control parameters:



Software Guide

Type:

Default parametric equalization, optional high and low shelf filters and high and low pass filters. Each type of filter has a different form to accomplish different functions.

High & Low pass:

The reference frequency of the pass filter is called the cutoff frequency, and the pass filter allows the frequency components on one side of the cutoff frequency to pass completely through the filter, while continuously attenuating the frequency components on the other side of the cutoff frequency. Among them, the high-pass filter (The High pass allows frequency components above the cutoff frequency to pass and filters out frequency components below the cutoff frequency. A low pass filter, on the other hand, allows frequency components below the cutoff frequency to pass and filters out frequency components above the cutoff frequency.

High & Low Shelf:

Also known as shelf filter. The meaning of high shelf filter is to boost attenuate the gain of the frequency portion above the set frequency. A low shelf filter is a partial gain boost or attenuation below the set frequency. The set frequency is not the cutoff frequency of 3dB, but the center point of the falling or rising edge of the filter. the Q value affects the peaking, and there is a mathematical relationship with the peak value.

Frequency (Hz):

The center frequency of the filter.

Gain (dB):

The gain boost or attenuation decibel value at the center frequency position.

Q:

The quality factor of the filter. The adjustable range of Q is 0.02~50; When the type is parametric equalization, the Q value represents the width of the bell-shaped frequency response curve between the two cutoff frequencies. When the type is High-Low Shelf or High-Low Pass, if $Q > 0.707$, there will be some peakedness in the filter response. If $Q < 0.707$, the slope will be flatter and the roll-off will occur earlier.

Each segment has a switch below the equalizer that indicates to turn the segment on or off, when off the parameter settings for each segment do not work. The equalizer has a master switch that indicates to enable or disable the module.

Software Guide

3.6. FeedBack

The use of feedback suppression modules should always be used in conjunction with good system design and engineering practices, not as a substitute for good system design. Traditional methods such as limiting the number of open mics, minimizing the distance from the source to the mics, positioning the mics and speakers for minimal feedback, and equalizing the room for a flat response should still be used. Only after that should a feedback suppressor be used to gain additional gain. A feedback suppressor will not magically fix a poorly designed system or increase transmission gain beyond the physical limitations of the system.

The Feedback Suppression module automatically detects and suppresses acoustic feedback in audio systems. The module distinguishes between feedback and the intended audio based on the characteristics of the signal. When feedback is detected at a certain frequency, a trap filter is automatically added at the frequency of the feedback to attenuate it. The first time it is added, the trap filter attenuates only slightly. If the feedback is still present, the trap continues to attenuate according to the set parameters until the feedback disappears or reaches the maximum value of the parameter setting. A variety of user parameters can be used to precisely fine-tune the effect of the module.

Filters can be locked after the ringer output to prevent them from changing during a performance. Filter settings can be copied to a dedicated trap filter module (such as an equalizer). The eight filters automatically cycle through the filters that are set to Auto, in this way removing filters that are only used temporarily.

Each channel has a Feedback Suppression, use the mouse to drag the input module to the Feedback Suppression module or quickly access the Feedback Suppression module by clicking the shortcut button on the right. To enable the Feedback Suppression module, click on the On button to automatically detect feedback points and reject them using narrowband filters, 8 narrowband filters per Feedback Suppression module.

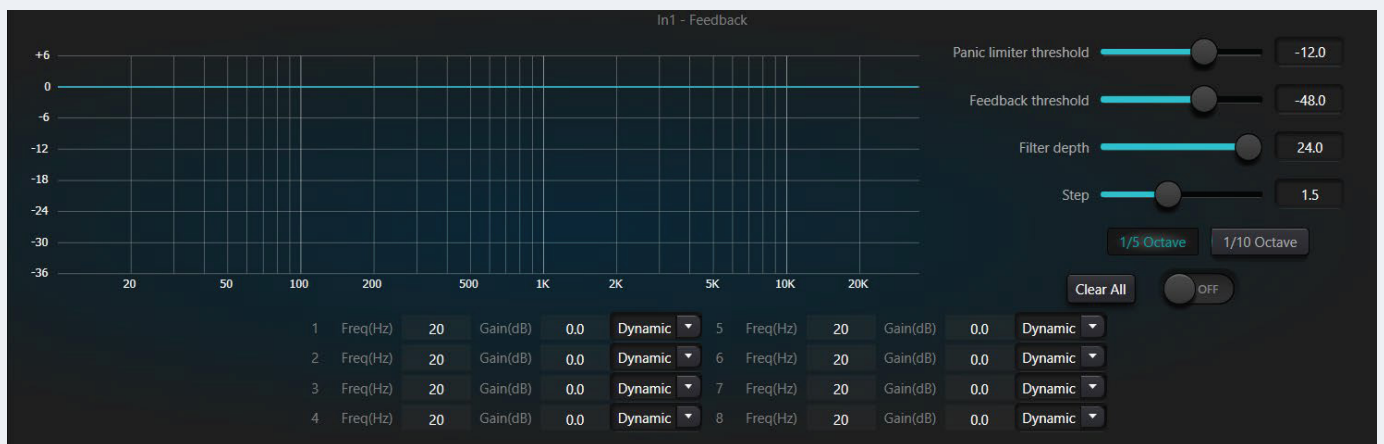

Software Guide

The adjustable parameters of the feedback suppression module are:

Panic Threshold:

This parameter tells the module: “Any level above this is definitely feedback.” When the signal level is above the feedback threshold: a) the output gain is temporarily attenuated to control the speed at which the feedback builds up, b) the output level is limited to prevent runaway, and c) the filter sensitivity is increased to detect the feedback faster. Once the output level drops below the threshold, the gain is restored and the sensitivity returns to normal. This value is referenced to the peak level of a full-scale digital signal. Setting this value to 0 is equivalent to turning this function off.

Feedback Threshold:

This reference tells the module: “Anything below this level is definitely not feedback.” This prevents the module from detecting feedback during soft music or because of low-level hum.

Filter Depth:

Sets the maximum attenuation that a single filter will be able to achieve. Shallower settings may prevent the filter traps from doing too much damage to the signal, but may also lead to worse control of feedback, especially in large narrow-resonance systems.

Bandwidth:

The options are 1/10 and 1/5 octave. Using a constant Q value, the filter does not get wider as the depth increases. It is recommended to set the bandwidth to 1/5 octave in speech environments where the filter bank is exhausted and feedback often occurs, as it has a wider bandwidth and a greater range of influence.

Presets:

Four built-in presets: “Music Big Room”, “Music Small Room”, “Voice Big Room”, “Voice Small Room”. These four presets fit the default settings of most applications.

Trap Auto:

Each trap contains three modes: ‘Auto, Manual, Fixed’”, set to Auto, the filter participates in the filter use, When the 8 filters are exhausted and new feedback is detected, the module will look for an ‘automatic’ filter setting and use it to suppress the new feedback. When set to Manual, the gain of the trap can be set manually. When set to Fixed, this filter parameter is always valid, is not taken up by new feedback points, and remains valid after reboot. If you need to save these feedback parameters, click the Save Preset button.

Software Guide

Clear:

Clicking this button instantly clears all filters. It will clear the feedback points that were previously checked for suppression. This operation is typically performed when recommissioning the feedback module.

The Feedback Suppressor can be used as a tool for system commissioning to find feedback frequencies, or as a preventive measure during normal operation. To obtain high system transmission gain and effective feedback suppression, it is recommended that the following steps be followed during commissioning:

- (a) Turn down the system gain and reset all filter parameters using the Clear button.
- (b) Set the parameter values of the feedback suppression module. Simultaneously reduce the panic threshold to lower the feedback generation level.
- (c) Turn on all microphones and slowly increase the system gain until feedback occurs. Stop increasing when feedback occurs.
- (d) Wait for the Feedback Suppression Module to act, and after the feedback disappears, continue to increase the gain.
- (e) Repeat until the system reaches the desired gain or all filters have been assigned.
- (f) Change the panic threshold to just above the desired maximum level of the non-feedback signal.

At this point, each filter can be set to Fixed mode if desired, or the dynamic state can be saved to handle feedback that may occur during a performance. Another possible option is to copy the filters to a trap module (such as an equalizer), which would add more filter capability.

If the equipment being used contains loudspeakers, it is recommended that a compressor/limiter module be used for additional protection. Setting a suitable limiter will ensure that the loudspeaker is not damaged, even if all the trap filters are exhausted or if the feedback suppressor is unable to control the feedback (e.g., if the system gain is too high)

3.7. Automatic Mixing (AutoMixer)

In a conference room, if multiple microphones are turned on to the same gain level and only one person is speaking, the result may not be very clear, the other microphones will pick up room noise, reverberation, etc., and when these signals are mixed with the normal microphone signals, it will greatly reduce the quality of the mixed audio output, and the entire sound reinforcement system is very susceptible to whistling, and not able to obtain sufficient sound transmission gain.

In order to solve this problem, it is necessary to turn off other microphones that are not in use for the time being. An automated mixer accomplishes this shutdown process and is much more responsive than manual operation.

Built into the processor is a gain-sharing automixer that supports up to 32 channels of audio signal input.

A direct output on each channel in the automix matrix is independent of the auto gain and channel faders, and is only affected by channel muting. For with a fixed volume, such as background music, that need to be kept at a fixed level without being controlled by the Automix; e.g., to keep the chairperson's microphone normally on and its gain unaffected by the Automix, the output of the channel can be adjusted directly in the Output Matrix Routing.

Software Guide

At this point, you can also turn off the channel's Auto Mix button, its gain will not be adjusted, and the signal level on that channel will not affect the gain on other channels.

The Automix module has two sets of control parameters: master control parameters and channel control parameters.

(1) Main control parameters

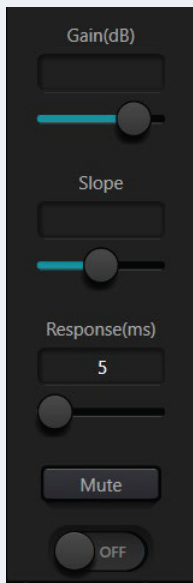

The buttons at the bottom turn the auto-mixing on and off

Gain:

Controls the volume of the main outputs of the auto-mixer

Slope:

The Slope control affects the attenuation of lower levels. At higher slopes, channels with lower levels are also attenuated more. The Slope control works similarly to the Ratio control on the Expander. It is recommended that the value be set at 2.0 or 2.0 The value in the vicinity. Setting it to 1.0 has the effect of turning off the auto-mix for all channels; setting it to When a value of 3.0 results in a gain adjustment of greater magnitude, an unnatural effect is possible. The larger the value set for The more channels open, the more overall attenuation. When the slope is set to 2.0, more desirable gain sharing is achieved and is the preferred value in use.

Response time:

A faster time ensures that talking heads are not excised. Slower times result in smoother operation. Practice has shown that the best results are achieved when the response time is 100ms and 1000ms. Auto Gain is designed to turn the microphone on much faster than it can be turned off, so even a 100ms response, speech heads are usually not cut off. If set to a slower time of a few seconds, the auto-mixer response time will have a longer hold time, and the last active channel will be preserved open for a few seconds.

Software Guide

(2) Channel Control parameters



Auto Mix:

Each channel has an Auto Mix On/Off button, which should be turned on for channels that need to participate in Auto Mix. It can also be turned off and the channel will not participate in the auto mix.

Mute:

Channel mute and fader are both after auto gain, even if a channel has been muted, the level gain of the other channels can still be reduced if the level of that channel is high.

Gain:

Adjusting the Gain fader increases/decreases the percentage of volume in the automix.

Priority:

Setting the priority can overwhelm the high priority channel with low priority, thus affecting the auto mixing algorithm, the parameter range is 0~10, the larger the value, the higher the priority.

Software Guide

Channel mutes and faders are both after auto gain, and any adjustments to these two parameters will not affect the auto mix operation. For example, even if a channel has been muted, it is still possible to reduce the level gain of other channels if the level of that channel is high. To mute a signal and prevent it from affecting the automix, turn on mute and turn off the automix. The mute button on each channel mutes that channel in the mix and also mutes the direct output. The channel faders also control the channel's mix level and direct output level. Click on the text box and enter a dB value to precisely control the channel level.

The Priority control allows higher priority channels to override lower priority channels, thereby affecting the automixing algorithm. The control can take values from 0 (lowest priority) to 10 (highest priority), with a default value of 5 (standard priority). The priority can be adjusted by using the slider, or by clicking on the edit box to enter a specified priority between 0-10. Increasing the value increases the priority.

If two channels with the same signal level magnitude are the same, the channel with the higher Priority will receive a higher Auto Gain. If there is a one-unit difference in Priority between two channels, the channel with the higher Priority will receive an additional 2dB (assuming the Slope is set to 2.0 for both channels) of Auto Mix Gain.

For example, if channel one's priority is set to 6 and channel two's priority is set to 3, and both channels have the same input level, channel one will receive an additional 6dB of mix gain over channel two.

Note that the slope setting of the Master Control parameter also affects the difference in mix gain due to the channel's priority. If the slope is set to 3.0, then a one unit difference in priority between channels results in 4dB gain difference. If all channels have the same priority, then leave all settings at the default level 5.

Note: In some setups extra care needs to be taken when using extreme priority differences between channels, e.g. 0 and 10. If a very high priority channel is recognizing signals such as background noise from the speakers, it may mask the lower priority channel, even if the very high priority channel is not in use, and the problem is worse the higher the slope. If you encounter this problem during installation and commissioning, consider adding a noise gate or expander between the automixers on the highest priority channels, and set the threshold to a level where the gate or expander will not be opened by background noise or speaker recognition.

3.8. Echo Cancellation (Echo Canceler)

Acoustic Echo Cancellation or AEC is a digital audio signal processing technique used in audio and video teleconferencing when the conversation takes place between the participants in the local room and one or more speakers some distance away. The AEC program increases the speech intelligibility of remote speakers by canceling acoustic echoes generated in the local room.

An echo cancellation module applied to far-end calls facilitates the local amplification of far-end speech signals, attenuating the interference of acoustic echoes. The basic working principle is to simulate the echo channel, estimate the possible echo formed by the far-end signal, and then subtract this estimated signal from the input signal of the microphone, so that the input voice signal no longer contains echo, so as to achieve the purpose of echo cancellation.

Software Guide

There is only one echo cancellation module in the DSP Controller, with 2 preset local inputs and a remote input mixer to enable multiple signals to participate in echo cancellation, as shown in the figure. There is one parameter to adjust: Non-Linear Filtering (NLP): Conservative, Moderate, Aggressive. These three optional types select the level of echo suppression.

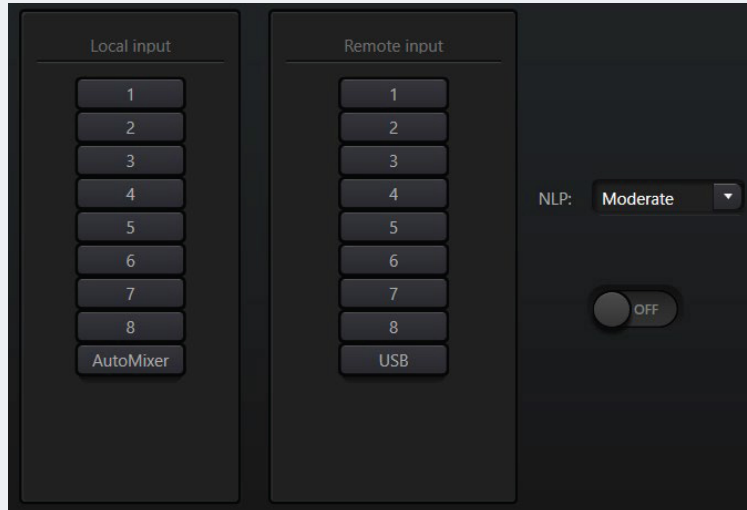

Note: The Echo Cancellation Module settings need to be used in conjunction with the Matrix Module settings for signal routing.

3.9. Noise Supression

The Noise Suppression Module effectively removes non-vocal sounds. Distinguish the human voice from the non-human voice, and treat the non-human voice as noise. A piece of audio containing both vocals and noise is processed by this module, and theoretically, only vocals remain.

There is only one noise cancellation module in the DSP Controller, which is preset with a multi-channel mixer to realize multiple signals to participate in noise cancellation, as shown in the figure.

Suppression level: There are three types of suppression available: Mild (6dB), Medium (10dB), and Aggressive (15dB). The meaning of dB is how many dB the suppression noise is reduced, the larger the value, the greater the damage to the voice, which is unavoidable.

Software Guide

Suppression level: There are three types of suppression available: Mild (6dB), Medium (10dB), and Aggressive (15dB). The meaning of dB is how many dB the suppression noise is reduced, the larger the value, the greater the damage to the voice, which is unavoidable.

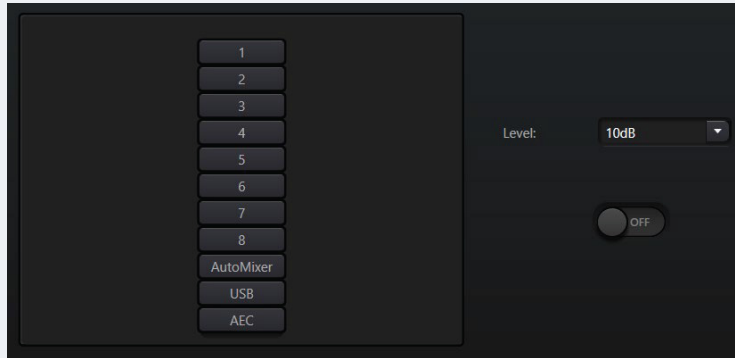

3.10. Matrix

The matrix has dual operation functions of routing and mixing. Horizontal indicates input channel and vertical indicates output channel, default one-to-one input and output as shown in the figure. If you need to mix the sound of Input Channel 1 and Input Channel 2 to Output Channel 1, mix the horizontal 1 and 2 are clicked on. If Input 1 and Input 2 are involved in Auto Mix, the outputs are not affected by Auto Mix. Similarly, after setting up the Auto Mix, Echo Cancellation, and Noise Suppression modules, you will need to set up the Matrix to get the correct signal routing relationships.

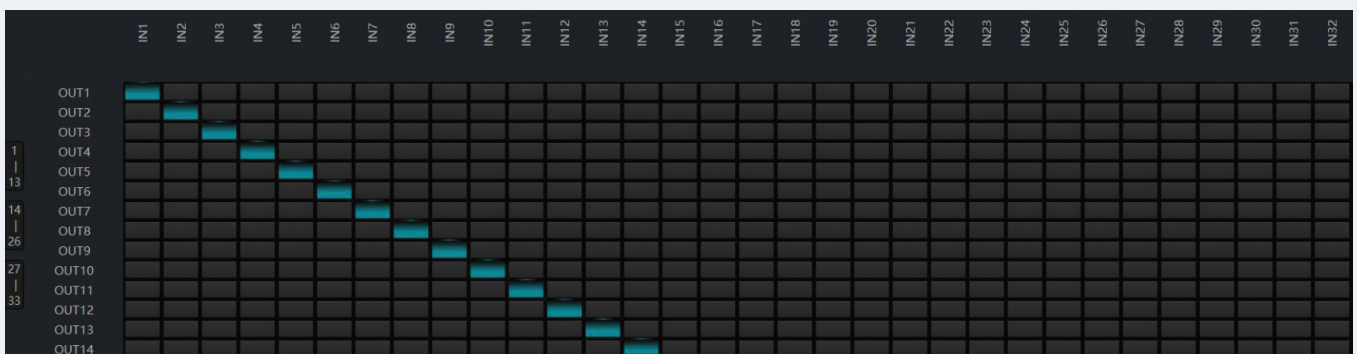

Software Guide

3.11. HighLowPass (HighPass&LowPass Filter)

Each output channel provides high and low pass modules consisting of a high pass filter and a low pass filter. Each filter has the following four parameters:

Frequency: The cutoff frequency of the filter, defined at -3dB for Bessel and Butterworth and -6dB for Linkwitz-riley.

Gain: The Gain setting affects the full-band boost or attenuation of the signal.

Type: Selects the filter type, which is Bessel, Butterworth, and Linkwitz-riley. Butterworth has the flattest passband.

Slope: The overband attenuation of the filter, there are eight choices of 6, 12, 18, 24, 30, 36, 42, 48dB/Oct. For example, 24dB/Oct means that in the transition band, the amplitude is attenuated by 24dB for every octave difference in frequency.

To activate the High Pass or Low Pass module, click the Activate button at the bottom.



Software Guide

3.12. Delay

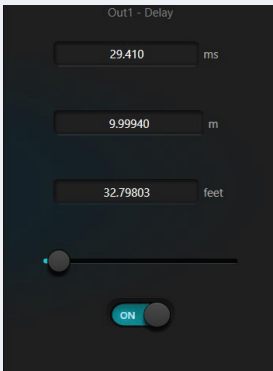

Activate button: Activates the specified delay module in the module, inserting it into the audio signal path to add a fixed delay time to the signal.

Milliseconds: Set the delay time of the delayer. The value ranges from 1 to 1200 milliseconds. Both meters and feet are converted unit values of milliseconds.

3.13. Output

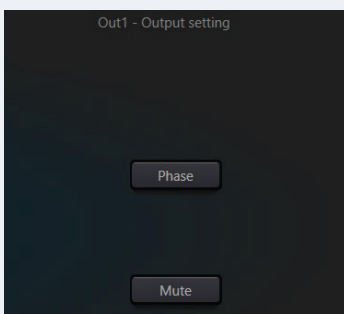

Invert: Reverses the phase of the audio signal by 180°.

Mute: Set mute/unmute.

On the output channel as on the input channel, there is also a partial menu to be set by right-clicking. Settings can be made as desired.

Group setting...
Minimum Gain:-72.0 Maximum Gain:12.0

Software Guide

3.14. USB Soundcard

The USB sound card is used for two functional purposes: one is to realize the recording and the other is the remote conference on the PC side. the USB sound has gone through the echo cancellation and noise cancellation module, which is very convenient to access to the remote conference. The USB playback in the software interface is only used for recording and playback.

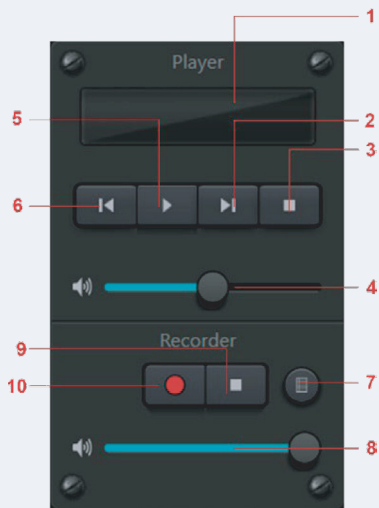

1. Song playback information, double-click to enter the playlist
2. Next
3. Pause
4. Song Playback Volume Adjustment
5. Play
6. Previous song
7. Recordings list
8. Recording Volume Adjustment
9. Stop recording
10. Start recording

Sound Card Settings

Connect the DSP processor to the computer host via a USB cable with a dual Type-A connector. When connecting for the first time, the computer will pop up to discover new hardware and install the driver automatically. After the installation is completed, the USB Soundcard will appear in the sound card list of your computer, as shown in the figure. Then select the USB soundcard in the software playlist and soundcard settings.

Software Guide

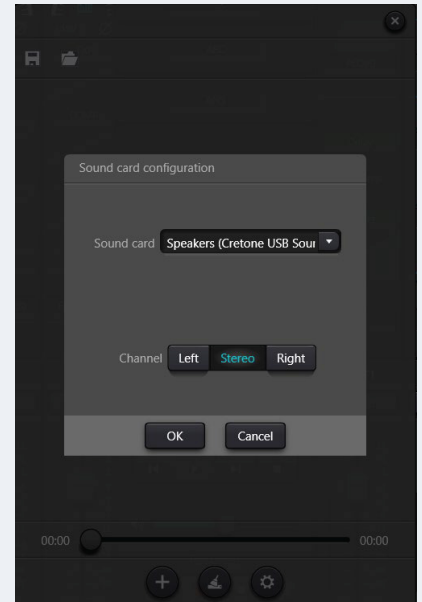
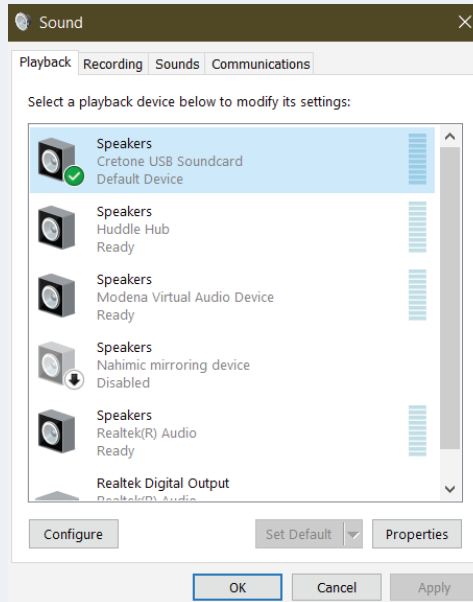
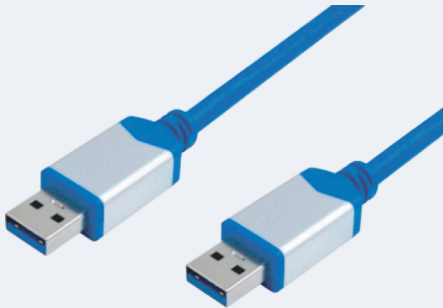

The playlist allows you to manipulate the song files, and you can also save the songs as a list and open it directly when you use it next time. Click **+** at the bottom of the playlist to open the folder and select the song to play, **🗑️** to clear the song list, **⚙️** to enter the sound card settings interface, as shown in the picture.

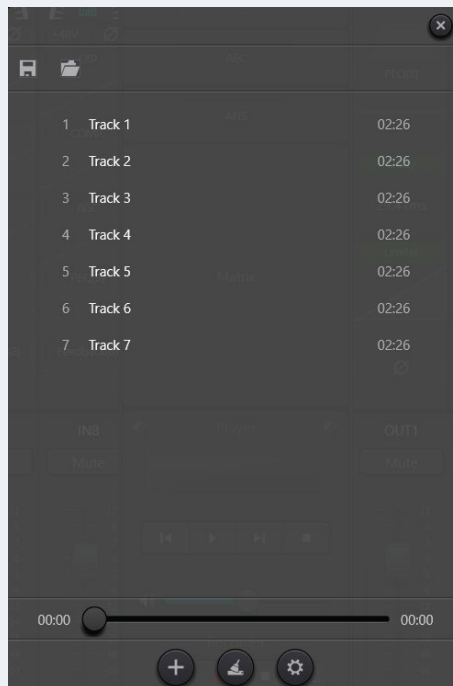

Software Guide

Setting Menu

1. File Menu

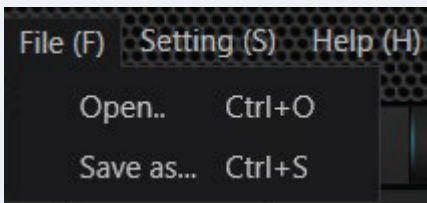

In offline mode, click on the Open pop-up file dialog box to select, Open an existing preset file (suffix: *.dsppro). You can also right-click on the preset file and open it using the DSP.exe application. "Save As" Saves the preset on the application to the local hard disk for easy copying and storage.

2. Device Setting

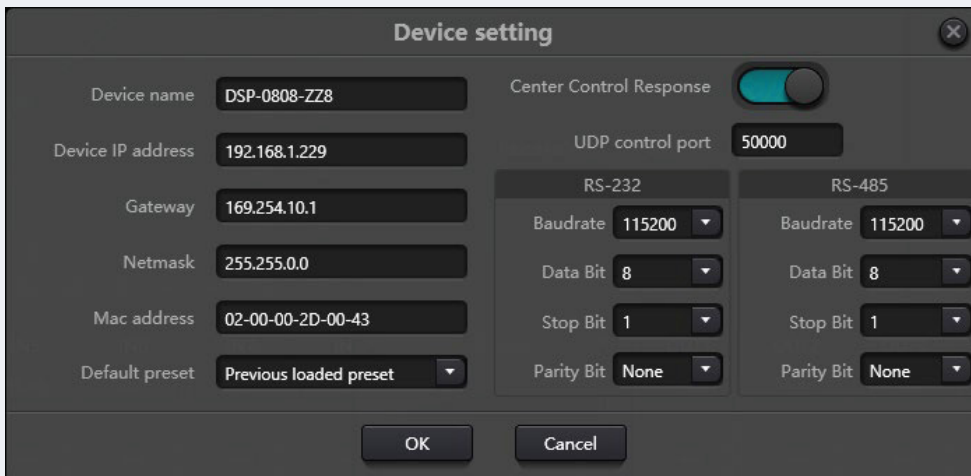

Set the device name, network address, and serial port baud rate. The maximum length of the device name is 16 characters.

Default Startup: You can select two startup preset modes, one is to specify any one of the 16 presets as the startup preset, and every time you turn on the power, it will start with that preset. The second is to select the last loaded preset and the last used preset before power failure as the next boot preset.

Software Guide

3. GPIO Setting (GPIO Setting)

Open the GPIO setup software interface, the device has a total of 8 GPIOs, which can be independently configured as inputs or outputs. Input GPIOs have Preset, Route, Gain, Mute, Command, and Analog to Digital Gain options. Output GPIOs can be selected from Preset, Level, Mute, Command.



Software Guide

Input GPIO Setting

Preset

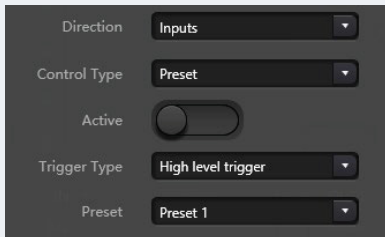

Trigger Type: High Level Trigger/Low Level Trigger/High Level Trigger, Low Level Cancel/Low Level Trigger, High Level Cancel, i.e. Rising Edge/Falling Edge Trigger/Rising Edge Trigger, Falling Edge Cancel/Falling Edge Trigger, Rising Edge Cancel.

Preset: Switch to this preset when the hardware GPIO port input trip type matches the trigger type set by the software.

Routing

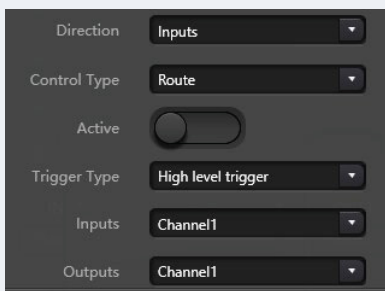

Trigger type: same as above

Input, Output: selects the input channel to be mixed by the output pair. Mix/unmix action when trigger conditions are met.

Gain

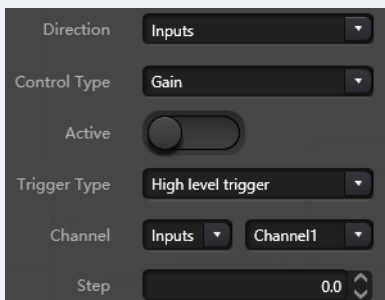

Trigger type: as above

Channel: Selects the input or output channel.

Step: Increase the step by one unit dB from the original gain of the channel.

Software Guide

Input GPIO Setting

Mute/
Unmute

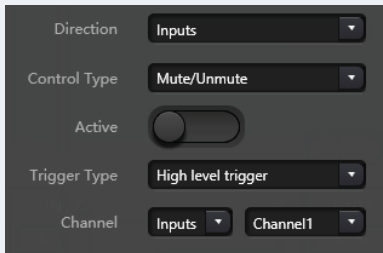

Trigger type: as above

Channel: Selects the input or output channel.

Command

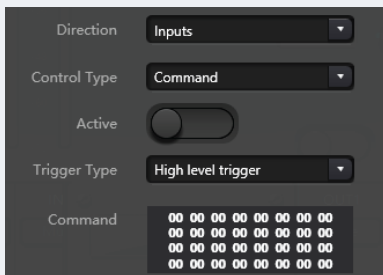

Trigger type: same as above

Command: This command code is sent out via RS232 when the conditions set by the trigger type are met.

Analog to
Digital Gain

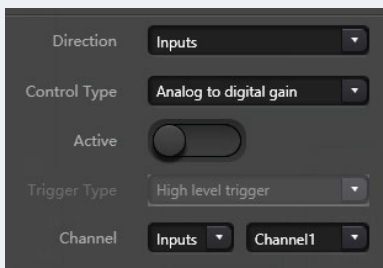

Analog to Digital Gain is useful when connected to an external potentiometer to adjust the gain of an input or output channel.

Similar in appearance to a rotary encoder, the difference with an encoder is that a potentiometer is analog and regulates the amount of voltage and current, while an encoder is digital and transmits a binary code of "0" "1"

Software Guide

Output GPIO Setting

Preset

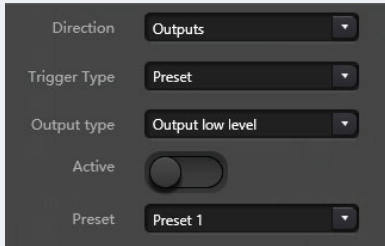

Output type: high level/low level

Preset: When switching to this preset, the corresponding GPIO port outputs high or low.

Routing

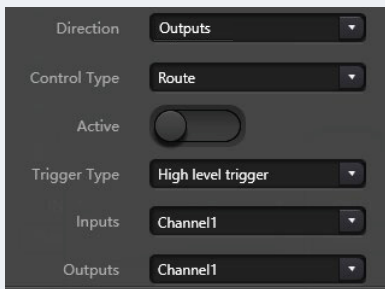

Output type: high level/low level

Channel: Specify the input or output channel

Level: When the specified channel level reaches the set level threshold, the GPIO outputs high/low level. Conversely, the opposite level is output.

Mute

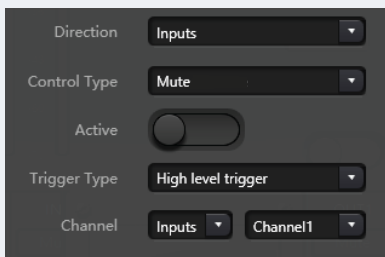

Output type: high level/low level

Channel: Specifies the input or output channel. When this channel is muted, the set high/low levels are output.

Unmute the channel and output the opposite level.

Software Guide

4. Group Setting

The grouping interface is divided into two tabs, input and output, and a maximum of 16 groups can be set under each tab. A channel can only participate in one group. Under the same group, their channel volume adjustment and mute adjustment are synchronized. Other module parameters are not synchronized, which is the biggest difference from the Link function.

There are 16 subgroups, and each subgroup can be selected from 1 - the maximum number of passes of the device. The maximum number of channels of the device depends on the model you have purchased. Channels are set into a group, which will be distinguished by a color in the main screen.

Relationship between grouping and LINK: When a channel is set up with grouping, it will not participate in LINK, meaning that grouping has a higher priority than LINK. the difference between grouping and LINK is that grouping can only control the channel gain and mute, while LINK links all the parameters on that channel.

5. Panel Setting (Pannel Setting)

Panel Setup includes 2 panel types: Pushbutton version and OLED screen version. Through the Panel Setup interface, multiple physical panels are connected to the DSP device via cables, and then the panel can be used to control the DSP device through simple panel settings.

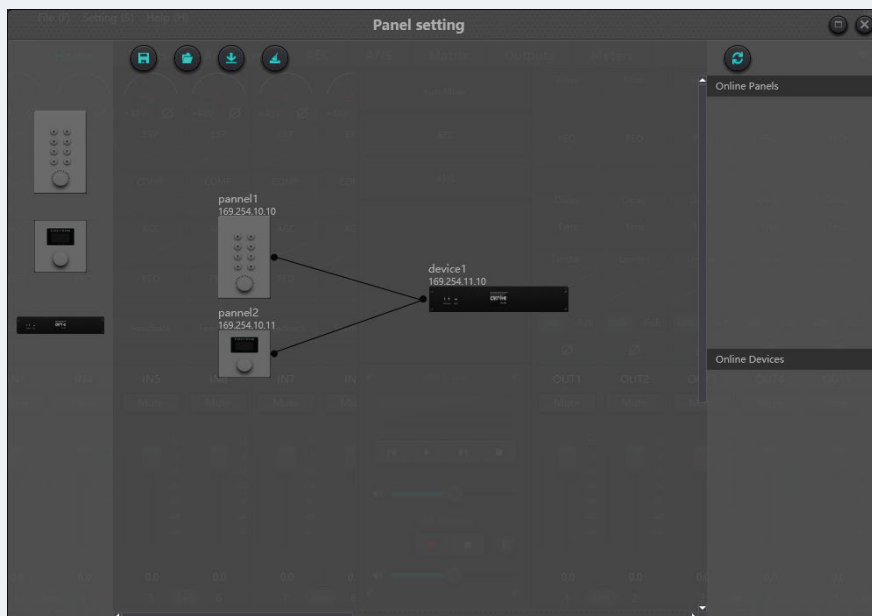

Software Guide

Offline devices: For offline editing state, the commissioning engineer first configures the panel parameters locally, and then downloads them to the online panel. Of course, you can also directly edit the online panel, in the online panel that column dragged out to the panel design area double-click to edit.

Notice that there is a small circle on both the panel and the device, click on the circle to pull out a line and select the destination device, this establishes a link between the 2 devices.

Double-click the panel in the design area to enter the panel configuration interface, the configuration of the two panels will be described separately below. After the configuration is completed, click the download icon in the toolbar to download the panel configuration to the hardware.

OLED screen panel:

The OLED panel consists of a 1.3" OLED screen and a knob. The OLED screen display strategy is hierarchical according to the menus, with three types of menus: volume, buttons, and presets. In the Panel Design area, double-click an OLED panel to enter the detailed settings of that panel. The following figure shows the detailed settings for an OLED panel.

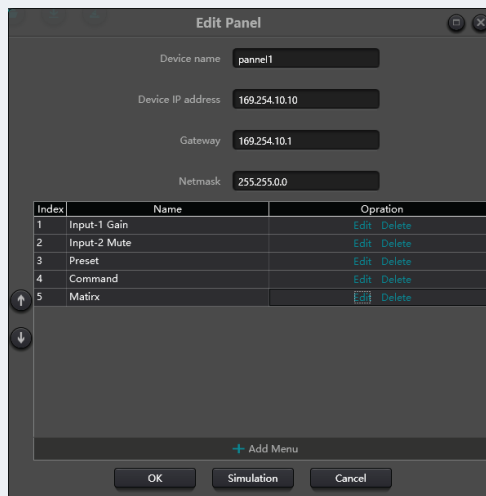

Click Add Menu to bring up the menu selection box, select the corresponding menu item and OK. After the software menu configuration is complete, click the download icon on the toolbar to download the configuration to the panel hardware.

Panel Operation Procedure:

1. In the main screen, the panel name and IP address are displayed, and the menu is switched by rotating the knob left or right.
2. Press the button on the knob and the second line of the menu screen begins to flash, indicating that it is in edit mode.
3. Use the knob to rotate left or right to change the value.
4. Press the button on the knob again to exit edit mode and return to menu mode.

Software Guide

Button panel:

The keypad has 8 keys and a knob. The knob is used for gain adjustment and the 8 buttons can be programmed for different functions.

The functions of the keys can be categorized into four types: Volume, Mute, Preset, and Command. Drag an item in the function area to the specified key to complete the programming of that key.

Again, after all the programming has been done, the emulation button can be used to see if the configuration is correct.

Panel operation light indication:

1. The key light is always on to indicate that the key is configured for mute.
2. A blinking button light indicates that the button is configured for gain, and the configuration knob is used in conjunction with it to adjust the gain of that channel. The 13 lights around the knob represent the gain, and light up or down depending on the amount of gain. All lights off represent -72 dB of gain, all lights on represent 12 dB.
3. The key lamp lights up momentarily when the key is pressed to indicate that the key is configured with a preset or command type function. Command Type Function: The command data comes from the central control command.

6. Dante Setting

Note: Before using the Dante setup, please check that your computer's network card is connected to the Dante network. The Dante Controller provides information on routing, channel information, network settings, etc. The device on the left shows the Dante device's receive channel. The device on the left displays the receive channel of the Dante device and the device on the right displays the transmit channel of the Dante device.

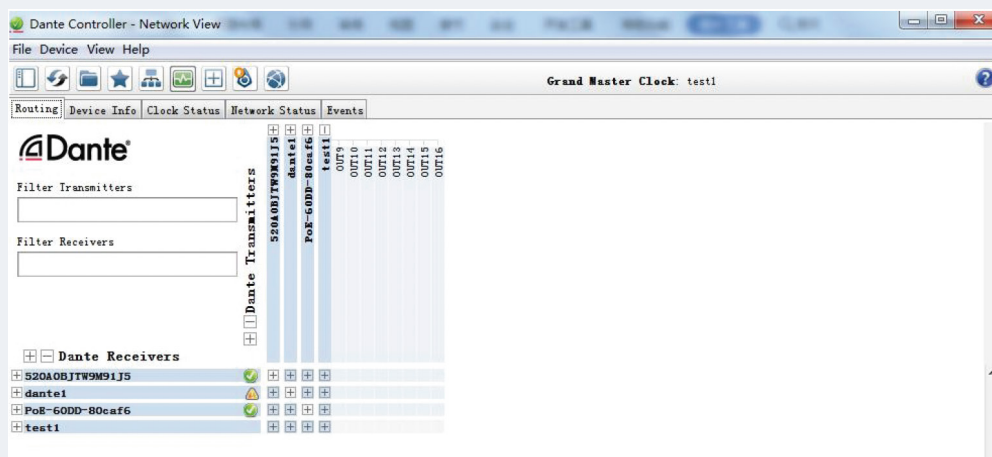

Software Guide

In the Routing screen, the small squares at the Send Channel and Receive intersections indicate that a routing relationship can be created. When clicked, the green icon ✓ will appear at the matrix intersection. You may initially see a gray icon ⏸ (very briefly) to indicate that the route is being processed.

If there is a problem with the routing, the warning symbol ⚠ or the error ❌ will appear. The yellow icon ⏸ may appear temporarily if multiple devices are subscribed at the same time.

Note: It is not possible to create routes with locked devices. However, existing routes can be deleted or replaced.

Cancel Audio Subscription

To cancel an audio subscription, click on an already subscribed cross. The subscription icon will be removed, restoring the original small square.

Subscription status

⏸	In Process	Subscription in process
✓	Subscribed	Connection established
⚠	Warning	Subscription not processed, usually because the sending device is not visible on the network
❌	Errors	Send error - for example, insufficient bandwidth on the network
⏸	Coming Soon	The device is processing subscriptions for other channels, most often many at once

Click Device Config to enter the detailed settings for this device as shown below.

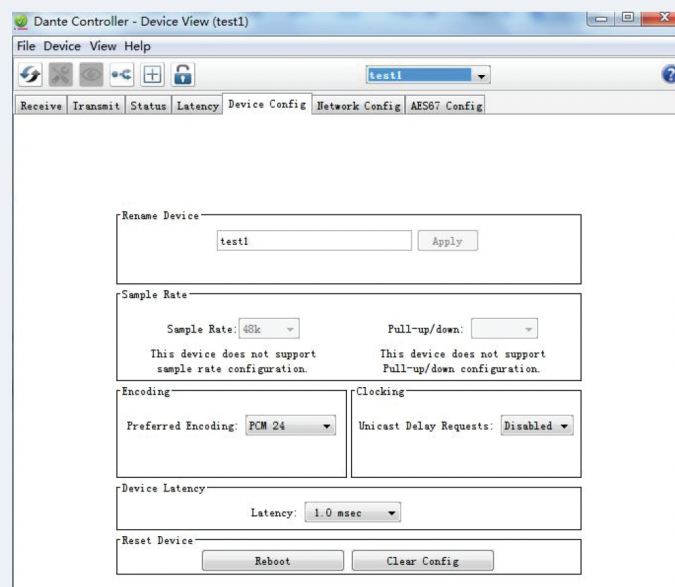

Software Guide

Transmit and receive labels can be modified with channel names, name naming rules:

All names of DSP devices are up to 16 characters in length, while Dante supports names up to 31 characters in length. Therefore, when using this interface for routing configuration, please make sure that the Dante device name and channel name length is less than 16 characters, otherwise the DSP Controller will truncate the process, which will cause subscription incorrectness.

Names are not case sensitive, "guitar" and "guitar" express the name.

Legal characters include A-Z, a-z, 0-9, and '-'.

The device name must not begin and end with the connective '-'. The device name must be unique on the network. Send channel labels can use any character except '=', ' ' and '@'. The transmit channel label must be unique within the device.

The rules for receiving channel names are similar to those for sending channels.

Device Configuration:

Modify the device name, audio sample rate, and delay. To modify the device name, you need to follow the rules of name modification. The delay is a key point to emphasize, in the Dante network, in the receiving end of a variety of delay needs to be compensated for, each receiving end, there is a device to set the delay (the delay of this interface). This delay represents the time difference between the samples coming in at the receiver and being played out. the default delay for Dante devices is 1ms, which is sufficient for large networks.

However, when the connection is established, there is an automatic negotiation process on the sender and receiver side to ensure that the delay is high enough to prevent packet loss.

For example, the Ultimo device supports a minimum latency of 1ms. if a faster device (such as a PCIe card) is set to a latency of 0.25ms, and it establishes a connection with the Ultimo device, the subscription latency will be 1ms, which is the minimum latency supported by the subscription. This is the minimum latency supported by the subscription.

The delay may be up to 1s in the network, and using a delay of less than 1s for transmission over a 100 Gigabit network will cause a subscription error.

Software Guide

Network Configuration:

Brooklyn supports setting up redundancy mode and switching mode. Redundancy Mode Many Dante devices have two network interfaces, called "Primary" and "Secondary". The "Primary" interfaces the physical network, and if the "Secondary" interface is used, the "Secondary" interface should be connected to a separate physical network. The "Secondary" interface is not capable of communicating with the "Primary" interface.

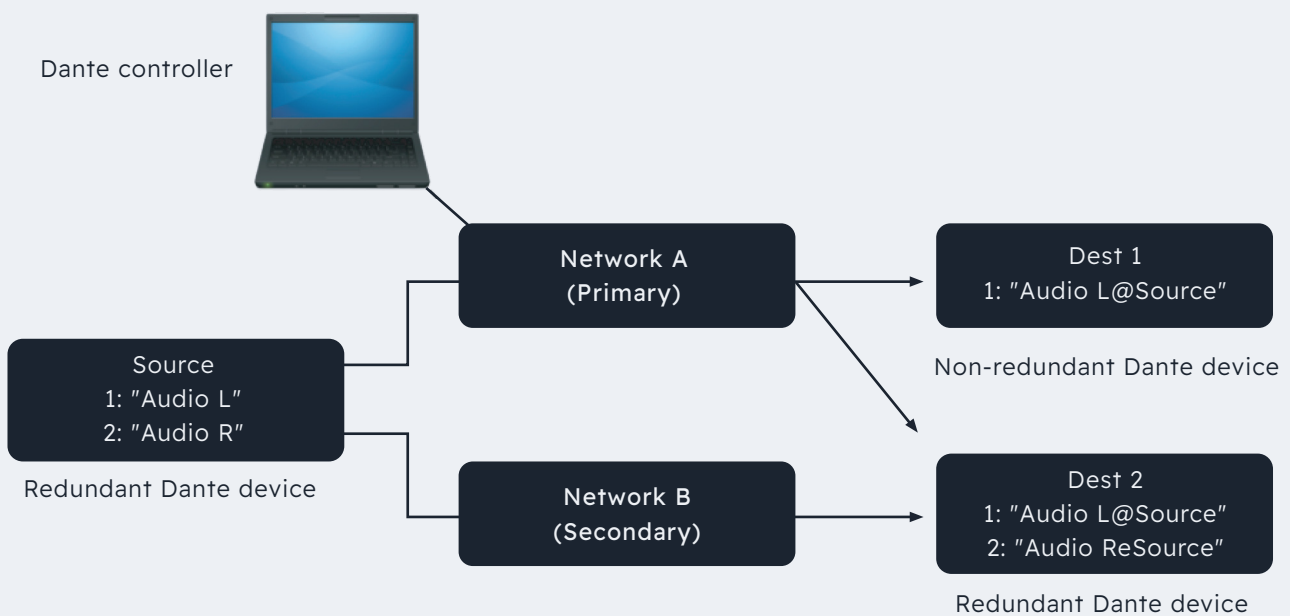

Software Guide

Multicast Streaming:

What is a stream: Dante Audio Routing automatically creates streams, a stream that moves several channels of audio data from a sender to a receiver or multiple receivers. Unicast streams go to a single receiver, multicast streams go to multiple receivers. Multicast streams can be created and configured manually through this interface. However, multicast streams consume network bandwidth, regardless of whether there is a receiving device or not, and do not require additional bandwidth when adding more receivers.

As shown in the figure, select the Multicast Streams tab, check Device Channels, and then click Create, the created multicast streams are displayed in the list on the right side of the interface. You can also delete it when you don't need it. By default, a stream contains 4 channels at most, if you check more than 4 channels, it will be split into multiple streams automatically.

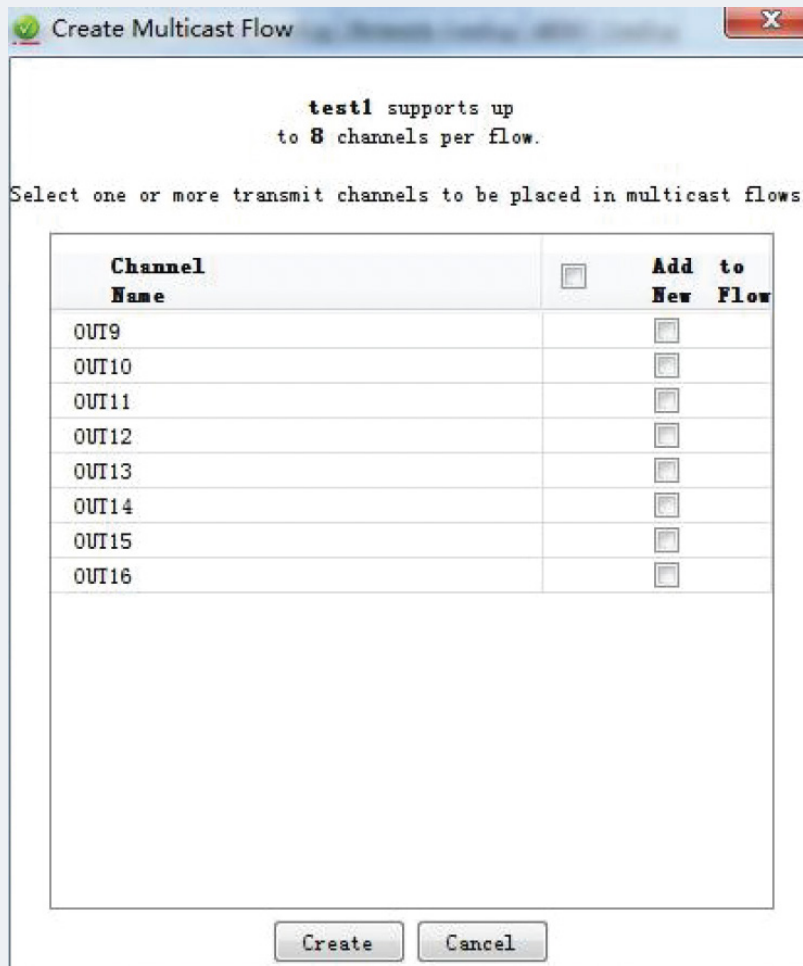

Software Guide

7. Help Menu

1. Central command

Open the command window of the center control, click the parameter you need to control on the interface, the center control command window will display the current command instantly. Copy the command and send it to the device using UDP or RS232.

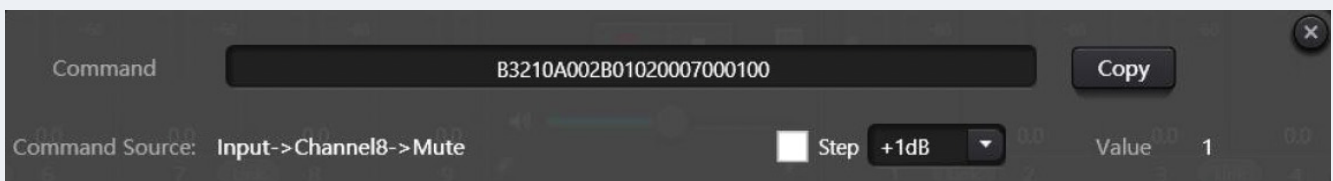

2. With respect to

Displays version number, technical support contact information, copyright information, etc.

8. User Interface

User Interface, a feature that allows engineers to create customized interfaces that can be edited by the integrator and operated by technicians in the field or by non-technical end users. Advanced security features allow end-users to have access to only those controls allowed by the engineer or system designer.

9. Mobile Device Usage

Online template selection

- After installing the software on the mobile terminal and opening it, be careful not to let the screen go out, and you must keep the mobile terminal and PC terminal on the same LAN. Please ask your equipment supplier for the download address of the software for mobile terminal.
- Editorial interface.
- Drag the top control to change the corresponding property.
- Upload.
- Click on the synchronization data can be uploaded to the mobile terminal, if encountered upload timeout or search for mobile devices can be closed and reopen the software.

Software Guide

Dante Audio

1. Dante Overview (Dante Overview)

Audinate's Dante technology delivers high-performance digital media networks to meet the high sound quality and performance requirements of professional live sound reinforcement, audio and video equipment installations, broadcast and recording systems.

Designed to fully exploit the performance of today's and tomorrow's network devices, Dante provides media transport mechanisms that eliminate many traditional audio network design limitations. Dante makes it easy to build a stable, flexible digital audio network with virtually unlimited performance. Dante networks can be designed with a mix of Gigabit and 100Mbps network speeds, while supporting audio with different sample rates and depths, and even allowing network zones to be designed with different latencies.

Dante is based on the Internet Protocol - not just Ethernet. Because Dante uses standard IP over Ethernet, it can be used in inexpensive It runs on off-the-shelf computer network hardware. And, with standard QoS, Dante can share the installed network with other data and computer traffic.

Dante provides precise synchronization of samples with the low latency required for professional audio. Dante's network-centric and similarly synchronized audio independence allows for fully synchronized broadcasts over different audio channels, devices and networks, even across multiple switch hops.

Dante makes networking a true plug-and-play process, allowing automated device search and system configuration. Dante-compatible devices will automatically set up their own network configuration, notify themselves, and channels on the network. Simplify complex, error-prone setup assembly procedures. Replaces "Magic Numbers" , network devices and their input and output signals can be renamed for easy user understanding.

Dante is not limited to allowing the configuration and transmission of audio channels. dante also provides mechanisms to send or receive control and monitoring information over its IP network, including device-specific information and controls specified and developed by specific manufacturers. With its solid foundation and evolving network standard with existing Dante products, Dante can be used for a variety of purposes.

Dante is able to provide a forward-thinking level of technology that would otherwise not be available for other types of digital audio transmission. Dante was designed from the ground up for gigabit networks. And, Dante as it exists today incorporates the emerging AVB networking standard. The continued evolution of its networking technology is an integral part of Dante's development.

Dante technology is available for ready-to-install hardware and software products, reference designs and development APIs. For more information, please visit the Audinate website at www.audinate.com.

Software Guide

Characteristics:

Based on existing IP-based networking technologies, including IEEE 802.3 and UDP/IP.

Uses off-the-shelf Ethernet hardware.

Uses standard VoIP (Voice over IP) style QoS (Quality of Service) to integrate existing networks.

The speed of Ethernet networks can be consolidated from 100Mbit to 1Gb.

The DSP's digital audio is a 24 bit, 48kHz sample rate. Dante itself can mix the sample rate and depth at the same time on the same network. Dante for DSP devices supports network latency as low as 0.25 milliseconds.

Device search, "plug and play" operation between devices. Automatic Label-based routing. Renameable data streams.

The number of Dante channels included in the DSP processor varies depending on the model of equipment purchased, and is available in 8x8 and 16x16 versions.

A PC or Mac can be connected directly to the Dante network using the Virtual Sound Card software downloaded separately from Audinate.

2. Dante Requirements (Dante Requirements)

All internal Dante connections use CAT6 cable.

If traffic control is performed within the same network, 30% of the available broadband is reserved. When using this reservation method, a 100Mbit link can handle up to 48x48 channels and a 1Gbps link can handle up to 512x512 channels at a sampling rate of 48kHz.

Daisy chain and uplink should be Gigabit.

Repeaters are not supported.

Use a commercial-grade managed switch when more than 10 local units or units more than 100 meters away are interconnected.

The switch must support the following features:

1. Quality of Service with 4 queues (abbreviated: QoS).
2. Distinguished Service Architecture with Strict Prioritization (DSCP).

Software Guide

3. Dante Network Design (Dante Network Design)

There are 2 typical topologies used for Dante networks.

10 or fewer units without redundancy

For systems with up to 10 non-redundant units, connect your PC to the Ethernet port and then daisy-chain the remaining Ethernet ports. Then, daisy-chain the Dante ports in the same manner. No dedicated Dante switch or configuration is required. Each unit needs to operate in Switched Port mode.

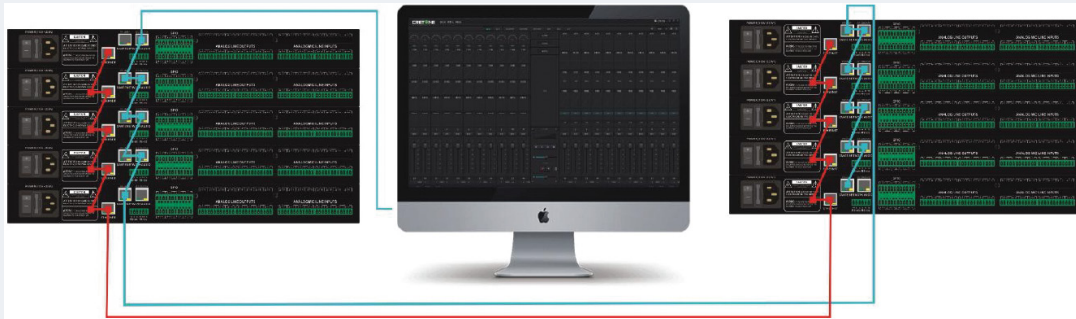

More than 10 units or more than 100 meters between units

For systems with more than 10 units or with distances between units greater than 100 meters, connect your PC with Ethernet ports on all units to one Ethernet switch and connect the Dante master port to a second Ethernet switch. Each unit needs to be in switch port mode (Switched Port mode).

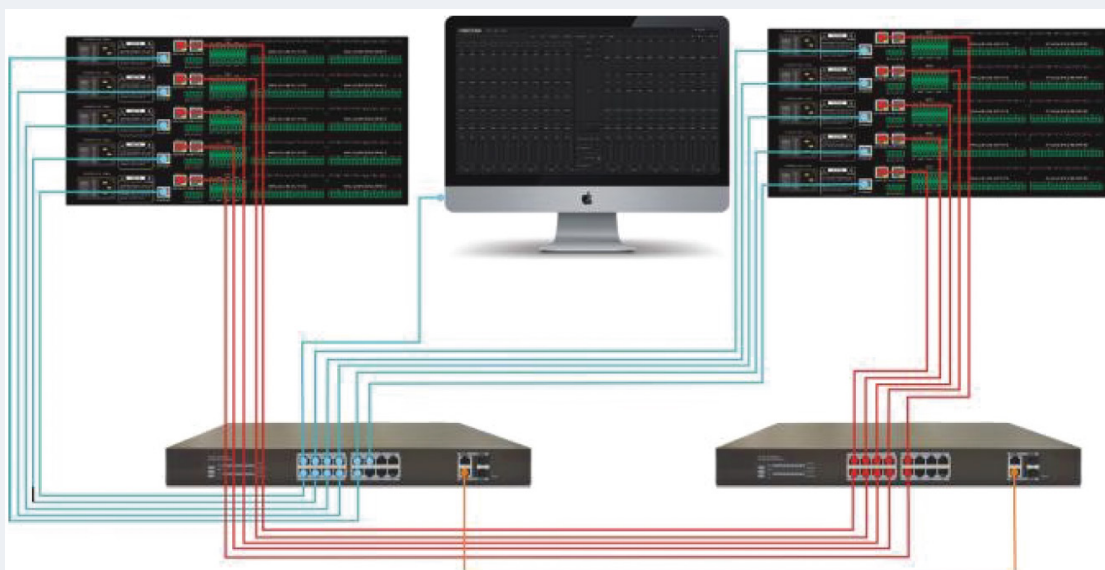

Software Guide

Latency:

The Dante Network Delay can be set through the Dante Flow Manager in the Tools menu.

Network latency increases with the number of switches. It is best to have fewer than 2 switches to minimize latency. The system allows up to 10 number of switches, but the latency increases. Always use the maximum practical value for latency. In many installations, latency is not determinative, such as when sending audio to an acoustically isolated room. In many cases, the highest latency can be selected to reduce overall network traffic and minimize problems with degraded audio output on an overloaded network. If low latency is critical, select a value that matches the number of switches across the network. It is usually safe to choose 0.25mS latency if you daisy-chain two units together or use a single Gigabit switch to connect them. Otherwise, choose 0.5 or 1.0mS delay, depending on your network topology.

In Dante, network delay variations are compensated for at the user's receiver. Each receiver has an Rx delay setting (also inside the Dante Settings (Device Info) in the DSP Controller). This setting limits the delay between the timestamps of incoming audio samples, and limits the amount of time the samples are played.

The default latency for most Dante devices is 1 mS. This is sufficient for a large network that consists of a Gigabit network core (up to 10 hops between switches) and 100M links to Dante devices. Smaller, gigabit networks can use lower latency values (down to 200 microseconds)

Note 1:

Dante delay is a "system level network delay setting". This means that there is no additional delay difference between each subsequent switch hop, e.g. the delay is not additive. As long as the (system-level network) delay setting is set long enough across the entire network path, packets can reach the end of the link before buffering ends. Dante then uses its clock calibration mechanism (Precision Time Protocol) to precisely calibrate the output. You can compare the self-clocks of any two Dante units that are within 100nS of each other, or less than the delay between the sampling periods.

1% (confirmed for up to 10 cells). Thus outputs at multiple points on the daisy chain will be aligned with samples, each with a specific delay from the sender.

Note 2:

Dante's actual delay is 3 sample intervals, or 0.06 mS longer than Composer's Dante delay setting indicates. this is caused by our DSP sample buffer, and is unavoidable.

Software Guide

4. Dante Mode (Dante Modes)

Problems such as inability to change modes or loss of audio may occur when the Dante device is still in switched mode, if it is connected with a cable for redundancy mode. Use the following procedure when switching the device from redundant mode to switched mode and vice versa.

1. When Dante is in switching mode, not in redundant mode, connect it to the network. In other words, if using an external switch or a direct connection between two devices, connect them to the main jacks only. If more than two devices are used without an external switch, daisy-chain the primary jack of one device to the secondary jack of the next. Do not * cause a loop* by plugging the last device into the first.
2. In DSP Controller, go to "Setting" -> Dante Setting -> Network Configuration (Network Config). Select redundant network or switch ports appropriately.
3. Powering down the system
4. Connect the Dante network to the new mode as appropriate. If you switch to redundant mode, you can now connect the primary and secondary jacks between two devices or between separate switches.
5. Power on the system.
6. Complete the schema change.

5. Dante Controller (Dante Controller)

Dante Controller is a software application provided by Audinate that allows users to configure and route audio across a Dante network. It is available for use on PCs running Windows XP, Vista, and Windows 7, and on Apple Macs running OSX10.5 and 10.6.

Once a customer installs Dante Controller on a PC and connects it to a Dante network, the customer can then use Dante Controller for:

- View all Dante-compatible audio devices and their channels on the network.
- View clock and network settings for Dante-compatible devices.
- Route audio to sends on these devices and view the status of existing audio routes.
- Change the label of the audio channel from a number to an appropriate name.
- Customize the receive delay (delay before broadcast).
- Save audio routing presets.
- Apply saved presets.

Software Guide

View and set configuration options for each device, including:

1. Change the device name.
2. Change the sample rate and clock settings.
3. View detailed network information.
4. Access a device web page to upgrade firmware and license information (where supported). For downloads of Dante controllers or help with them, go to the Audinate website.

6. Dante Virtual Soundcard (Dante Virtual Soundcard)

Dante Virtual Soundcard is a software application available for purchase from Audinate that transforms a customer's PC or Mac into a Dante-compatible device, allowing Dante audio to be transmitted and received using standard Ethernet without the need for additional hardware. The latest version of Dante Virtual Soundcard uses the standard Core Audio (Mac OS X) or Steinberg ASIO (Windows) audio interface and can be used with any audio-enabled application. The latest version of the Dante Virtual Sound Card uses the standard Core Audio (Mac OS X) or Steinberg ASIO (Windows) audio interfaces can be used with any audio-enabled application.

Once a user installs a Dante virtual sound card on a PC or Mac and connects it to a Dante network, the user can:
View and change existing audio sample rates.

Customize the receive delay (the receiving device should use the delay before playback).

View and set up your computer's Ethernet port, and view network interface details Start and stop the Dante Virtual Soundcard.

Select the number of audio channels available on the Dante Virtual Soundcard. On Windows systems, users can:

View and set ASIO-specific parameters.

NOTE: Users must install the Dante Controller on a PC or Mac in a Dante network to control and route audio. It can be installed on the same computer as the Dante Virtual Sound Card software. To download Dante virtual sound card software or for help, visit the Audinate website.

Software Guide

Control

1. External Control Programming (External Control Programmer)

External control programming supports UP and RS232, and the control protocol covers all the control parameters of the processor, including parameter control, parameter acquisition, and preset calling.

When using UP control, the default port is 50000, and the port can be set through the host computer software inside "Device Settings".

Using RS232 control, the default baud rate is 115200 with 8 data bits, 1 stop bit and no parity bit. Again this can be set inside the "Device Settings".

When RS232 sending, the interval between messages needs to be kept more than 100 milliseconds.

If the center control needs to reply, please turn on the center control reply switch inside the "Device Settings".

Device setting	
Device name	DSP-0808-ZZ8
Device IP address	192.168.1.229
Gateway	169.254.10.1
Netmask	255.255.0.0
Mac address	02-00-00-2D-00-43
Default preset	Previous loaded preset
Center Control Response	<input checked="" type="checkbox"/>
UDP control port	50000
RS-232	
Baudrate	115200
Data Bit	8
Stop Bit	1
Parity Bit	None
RS-485	
Baudrate	115200
Data Bit	8
Stop Bit	1
Parity Bit	None

2. Control Protocol

For historical reasons, the latest control protocol uses variable length and is fully compatible with the old fixed length control protocol.

In the protocol, the fourth byte is used for version differentiation, with 0- indicating version V1 (historical version) and 1- indicating version V2 (current protocol version).

The difference between V1 and V2 is that V1 can control all processing module parameters, but only one parameter can be controlled by one command. Suppose there is a need for one command to control multiple consecutive channels, then the V2 version is required. Or if there is a need to trigger the GPIO of the device to output high and low levels by pressing a key in the keypad, or to send a command via RS232/RS485, then the V2 version will be very suitable.

Software Guide

Software coding rules (12 bytes total):

byte1	byte2	byte3	byte4	byte5-12
0xb3	Message Type	lengths	version number	digital

V1 version:

Message type (byte2): three types, 0x21 (parameter control), 0x22 (parameter acquisition), 0x13 (toggle scene)

Length (byte3): invalid.

0x21 (parameter control):

At this time Data byte5-12 are respectively:

byte 5-6	byte 7-8	byte 9-10	byte 11-12
Module ID	Parameter type	Parameter value 1	Parameter value 2

See Appendix A for **module ID** (byte5-6) assignments.

See Appendix B for **parameter types** (byte7-8).

Parameter value 1 (byte9-10) When there is only one parameter, only parameter value 1 is valid, for example, to control the compressor switch.

Parameter value 2 (byte11-12) is valid when there are 2 parameters, e.g. control input channel 1 mute. Parameter value 1 is filled with the input channel number (starting from 0) and parameter value 2 is filled with 1 (mute).

Special case:

matrix routing has three parameters, the first is the input channel number, the second is the output channel number, and the third is the routing switch. In this case, parameter value 1 byte9 is filled with the input channel number, byte10 is filled with the output channel number, and parameter value 2 is filled with the routing switch.

0x22 (parameter acquisition):

The parameter acquisition rules are the same as those for parameter control, but the difference is that the acquired values are filled in the place of parameter 1 and parameter 2.

Software Guide

0x13 (switching scenes):

Simply fill in the scene number (0~15) at byte and 0at byte6~12.

Note: The v1 Center Command can be accessed via the PC software menu bar: Help - Center Command.
For customized development, please use the protocol rules.

V2 version:

Message type (byte2): three types, 0x21 (parameter control), 0x22 (parameter acquisition), 0x13 (toggle scene), 0x74 (other control), 0x6e (Dante routing).

Length (byte3): Fill in the corresponding data area length according to the message type. Variable length when actually sending, according to the data length plus 4 bytes of header information, that is, the total amount of data.

1. Parameter control (0x21)

The format of the data area at this point is:

byte5	byte6	byte7	byte8	byte9-72
Input/Output	Start Channel	End Channel	Parameter type	Parameter value

byte5: Indicates control input or output channel, 0x2-input channel, 0x1-output channel. byte6-7: Start channel number and end channel number, channel number starts from 0.

byte8: Parameter type same as V1 version, see Appendix B.

byte9-40: Fill in the parameter values from the start channel to the end channel, start writing from the 9th byte, each parameter value occupies 2 bytes.

2. Parameter acquisition (0x22)

The format of the data area is the same as the parameter control, the parameter value can be left out. The parameter value can be left out. The obtained parameter will be filled in this position.

3. Switch scene (0x13)

byte5: Fill in the scene number (0-15). byte6-8: Fill in 0.

Software Guide

4. Other controls (0x74)

Other controls include but are not limited to: GPIO, RS232, RS485, and center reply. The protocol format is as follows: GPIO:

byte5	byte6	byte7	byte8	byte9	byte10	byte11	byte12
Type of control	Data length	Reservations	Reservations	GPIO Direction	Start GPIO	End GPIO	(be) worth

byte5 Control type is 1

The byte6 data length is fixed at 4 bytes.

byte9 GPIO direction, set input or output, value 0 means input, value 1 means output.

byte10-11 Start GPIO and End GPIO, there are 8 PIOs in the DSP device, which are indicated by serial number 0-7 respectively.

byte12 Depending on the byte9 GPIO direction, this field is filled with a high (1)/low (0) level when set to output. When set to input, this field is a return field that reads the GPIO level value on the device.

RS232/RS485.

byte5	byte6	byte7	byte8	byte9-132
Type of control	Data Length	Reservations	Reservations	Digital

byte5 2 for control type RS232, 3 for RS485.

byte6 Data Length The length of the data currently to be sent via RS232/485. byte9-132 Fill in the data sent by RS232/485.

Software Guide

Central Control Replies:

byte5	byte6	byte7	byte8	byte9
Type of control	Data length	Reservations	Reservations	Reversing switch

byte5 The control type is 4.

byte6 The data length is 1.

A byte9 of 1 turns the center reply switch on and a 0 turns the reply off.

5. Dante Routing (0x6e)

The data area format is:

byte5	byte6	byte7	byte8	byte9~24	byte25-40
Dante Channel Number	Routing switch	Reservations	Reservations	Subscription Channel Name	Subscription device name

byte5 Dante channel number, with the difference that the Dante channel number starts from 1.

byte6 Dante Channel Subscribe/unsubscribe to the specified channel of the Dante device indicated by byte25-40. The specified channel is indicated by byte9-24 channel name.

Software Guide

3. Serial to UDP (RS232 To UDP)

The DSP device supports RS232 to UDP with the following protocol format:

4-byte prefix	4bytes	2bytes	1byte	1byte	128bytes
UDP.	IP address	Ports	Data length	Reservations	Digital

When the RS232 receives a packet in this protocol format, it forwards the data in the protocol to the device with the specified IP address and port.

For example, send data "HELLO DSP" to port 50000 of the device " 192.168.10.22". The protocol command is.

4-byte prefix	4bytes	2bytes	1byte	1byte	128bytes
0x3a504455 (' :PDU * ')	0x1610A8C0	0xC350	0x09	0x00	"HELLO DSP"

Application: This function can be applied in many cases where the central control host does not have a network interface. As shown in the figure, the center control host is connected to the DSP device through RS232, and the DSP device is connected to the Ethernet through the network cable. In this way, the center control host through the serial port to network commands to control any network device.

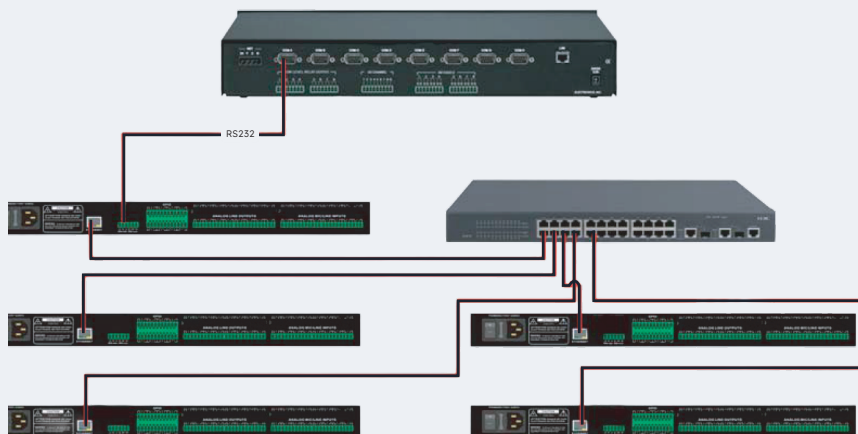

Software Guide

Common Problems

1. How do I restore factory settings?

Connect to the computer via RS232 and run the serial port software (SecureCRT is recommended). The default baud rate of the serial port is 115200, 8 data bits, no parity, and 1 stop bit. After SecureCRT connects to the serial port, press and hold the enter key in the terminal interface, restart the machine, and enter the bootloader boot dialog box, as shown in the figure.

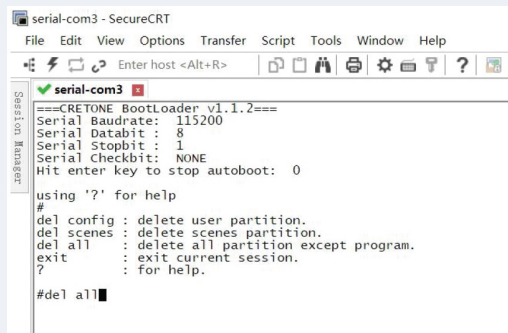

Command Details.

del config: Deletes configuration information, such as IP address and other network configurations. After deletion, the device reverts to the default IP address: 169.254.20.227. **del scenes:** Deletes the presets. 16 presets of the DSP device are all restored to their default values.

del all: Deletes all partitions except programs.

Note: Some SecureCRT may not show up after installation, please check "Local echo" in Options->Session Options, as shown in the figure.

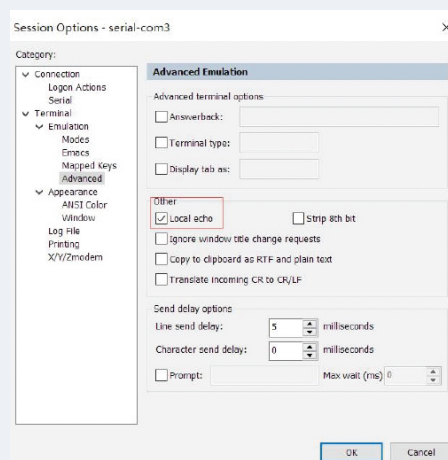

Software Guide

Appendix A: Module ID Assignment

Module Name	ID
Input Source	299
Input channels 1-32 Expander	1~32
Input Channels 1-32 Compressor	33~64
Input channels 1-32 Auto Gain	65~95
Input channels 1-32 Equalizer	97~128
Input Channels 1-32	129~160
Feedback Suppression Auto	161
Mixing Echo Cancellation	163
Noise Suppression	165
Mixer	166
Exports	295
System Control	296
Output Channels 1-32 High and Low Pass	167~198
Output Channels 1-32 Equalizer	199~230
Output Channels 1-32 Delay Timer	231~262
Output Channels 1-32 Limiter	263~294
Echo Cancellation Selector	162
Noise Suppression Selector	164

Software Guide

Appendix B: Module Parameter Types (1)

Module Name	Parameter Type	Clarification
Input Source	0x1	Gain (Electronics)
	0x2	Unmute
	0x3	Level of Sensitivity
	0x4	Phantom Power Switch
	0x5	Signal Generator Type
	0x6	Signal Generator Frequency
	0x7	Sine Wave Gain Size
	0x8	Channel Name
	0x9	Reversed-phase (Physics)
	0x10	Gain Step
	0x11	Link
	0x12	Channel Level
Delayer	0x1	Bypass Switch
	0x2	Millisecond
	0x3	Microsecond
Equalizer	0x1	Equalizer Main Switch
	0x2	Sub-segment Switch
	0x3	Frequency
	0x4	Gain (Electronics)
	0x5	Q Value
	0x6	Typology

Software Guide

Module Name	Parameter Type	Clarification
Exports	0x10	Gain Step
	0x11	Link
	0x12	Channel Level
	0x1	Gain (Electronics)
	0x2	Unmute
	0x3	Channel Name
	0x4	Reversed-phase (Physics)
	0x5	(Level of) Sensitivity
	0x6	Gain Step
	0x7	Link
Extender	0x8	Channel Level
	0x1	Switchgear
	0x2	Thresholds
	0x3	Ratios
	0x4	Establishment Time
Compressor	0x5	Release Time
	0x1	Compressor Switch
	0x2	Compressor Threshold
	0x3	Compressor Ratio
	0x4	Establishment Time
	0x5	Recovery Time
	0x6	Gain Compensation

Software Guide

Appendix B: Module Parameter Types (2)

Module name	Parameter type	Clarification
Mixer	0x1	Mixing switch
	0x2	Mixing Gain
High and low passes	0x1	Qualcomm Switch
	0x2	Qualcomm Type
	0x3	Qualcomm Slope
	0x4	Highpass frequency
	0x5	Qualcomm Gain
	0x11	Low-pass switch
	0x12	Low Pass Type
	0x13	Low-pass slope
	0x14	Low-pass frequency
	0x15	Low Pass Gain
Automatic mixing	0x1	Total Mute
	0x2	Total gain
	0x3	Slope
	0x4	Response time
	0x5	Passageway automatic switches
	0x6	Channel muting
	0x7	Channel Gain
	0x8	Prioritization
	0x9	Auto Mixer Switch

Software Guide

Module Name	Parameter Type	Clarification	
Feedback Suppression	0x1	Switchgear	
	0x2	Feedback Point Frequency	
	0x3	Feedback Point Gain	
	0x6	Presuppose	
	0x7	Removals	
	0x8	Panic Threshold	
	0x9	Feedback Depth	
	Auto Gain	0x1	Switchgear
		0x2	Thresholds
0x3		Target Threshold	
0x4		Ratios	
0x5		Establishment Time	
0x6		Release Time	
Echo Cancellation	0x1	Echo Cancellation Switch	
	0x2	Echo Cancellation Mode	
Noise Suppression	0x1	Noise Suppression Switch	
	0x2	Noise Suppression Mode	
System Control	0x1	System Mute	
	0x2	System Gain	

Connection Guide

Audio Wiring (AWR)

Balanced Connection

Either of these interfaces could be on either side of a balanced connection.

Note: For an XLR connector, the female connector is connected to the output and the male connector is connected to the input.

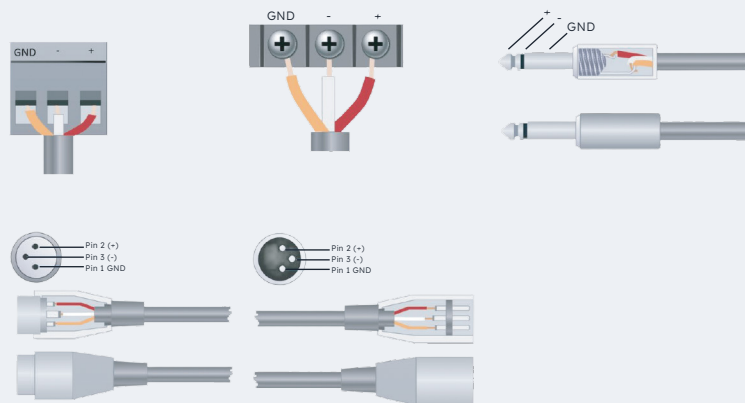

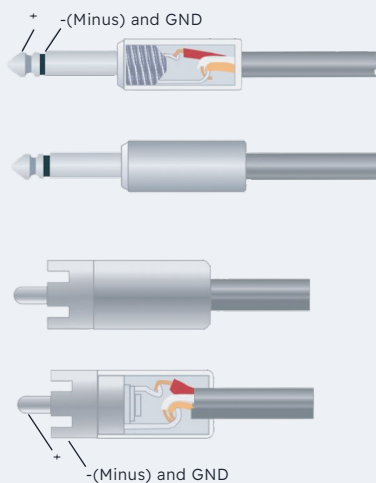

Unbalanced Connection

The RCA connectors and the 1/4-inch TS connector are unbalanced connectors with a multi-stranded shielded cable installed and can be placed at either end of the unbalanced connection.



Hazard/Warning Note

	<p>The exclamation mark in an equilateral triangle alerts users to important safety instructions in the user manual. Please read carefully.</p>	
<p>1. Read these instructions. 2. Keep these instructions. 3. Heed all warnings. 4. Follow all instructions. 5. Do not use this apparatus near water. 6. Clean only with a dry cloth. 7. Do not block any ventilation openings. Install in accordance with the manufacturer's instructions. 8. Do not install near any heat sources such as radiators, heat registers, stoves, or other apparatus (including amplifiers) that produce heat. 9. Do not defeat the safety purpose of the polarized or grounding-type plug. A polarized plug has two blades with one wider than the other. A grounding type plug has two blades and a third grounding prong. The wide blade or the third prong are provided for your safety. If the provided plug does not fit into your outlet, consult an electrician for replacement of the obsolete outlet. 10. Protect the power cord from being walked on or pinched, particularly at plugs, convenience receptacles, and the point where they exit from the apparatus.</p> 	<p>11. Only use attachments/accessories specified by BAT. 12. Use only with the cart, stand, tripod, bracket, or table specified by the manufacturer, or sold with the apparatus. When a cart is used, use caution when moving the cart/apparatus combination to avoid injury from tip-over. 13. Unplug this apparatus during lightning storms or when unused for long periods of time. 14. Refer all servicing to qualified service personnel. Servicing is required when the apparatus has been damaged in any way, such as power-supply cord or plug is damaged, liquid has been spilled or objects have fallen into the apparatus, the apparatus has been exposed to rain or moisture, does not operate normally, or has been dropped. 15. Never introduce objects into the vents of the device. Doing so may contact high-voltage components or cause a short circuit, leading to fire or electric shock. Keep liquids away from the device. 16. Do not attempt to repair this device yourself. Opening the device can expose you to high voltages and other risks. For all</p>	<p>maintenance or repairs, contact qualified professionals. 17. Replacement Components: When replacement parts are required, be sure the service technician uses replacement parts specified by the manufacturer or have the same characteristics as the original part. Unauthorized substitutions may result in fire, electric shock, or other hazards. 18. Safety Check: Upon completion of any service or repairs to this device, ask the service technician to perform safety checks to determine that the device is in proper operating condition. 19. This appliance shall not be exposed to dripping or splashing water and that no object filled with liquids, such as vases, shall be placed on the apparatus. 20. In order to avoid damaging your hearing, do not listen to loudspeakers at high volumes for extended periods. Listening to speakers at high volumes can damage the user's ears and may lead to hearing problems. 21. Exposure to excessive volumes (over 85dB) for more than one hour can cause irreparable damage to your hearing.</p> 

Warranty

Your **BAT Amplifier** is accompanied by a separate warranty document outlining the specific terms and conditions of your coverage.

Please refer to this document for detailed information regarding the duration of the warranty, what is covered, and the process for making a claim. We recommend retaining your proof of purchase along with the warranty document for convenient reference. For any warranty-related inquiries, please contact your authorized BAT dealer or reach out to us directly using the contact information provided in this manual."

Disclaimer

Information contained in this manual is subject to change without prior notice and does not represent a commitment on the part of the vendor. We shall not be liable for any loss or damages whatsoever arising from the use of information or any error contained in this manual.

It is recommended that all services and repairs on this product be carried out by us or its authorized dealer.

This product must only be used for the purpose it was intended by the manufacturer and in conjunction with this operating manual.

We cannot accept any liability whatsoever for any loss or damages caused by "service, maintenance or repair by unauthorized personnel" or by use other than that intended by the manufacturer.

Contact Us

info@bataudio.com
www.bataudio.com
United Kingdom

 **BAT.**
BRITISH ACOUSTIC TECHNOLOGY