



BLOQ 4

User Manual

TABLE OF CONTENTS

- 01 Acknowledgments**
Appreciation and warm welcome to the BAT family.
- 03 What's in the Box?**
A quick overview of all items included in the package.
- 04 Key Features**
Highlights of the main functions and benefits.
- 05 Specs Sheet**
Detailed technical specifications of the product.
- 05 Dimensions**
Physical measurements and size details.
- 06 Technical Data**
Performance, measurements, and acoustic data.
- 07 Installation Guide**
Overview setup and mounting instructions.
- 08 Hazard/Warning Note**
Important safety cautions and potential risks.
- 09 Warranty/Disclaimer**
Coverage terms and conditions for product support.

Acknowledgments

EN

Thank you for choosing BAT.

Your trust in our commitment to sonic precision and purposeful design means the world to us. Each BAT product is the result of rigorous engineering, careful craftsmanship, and a relentless pursuit of acoustic clarity. We hope it brings richness and reliability to every sound you experience. Welcome to the BAT family.

FR

Merci d'avoir choisi BAT.

Votre confiance en notre engagement envers la précision sonore et le design réfléchi nous touche profondément. Chaque produit BAT est le fruit d'une ingénierie rigoureuse, d'un artisanat soigné et d'une quête incessante de clarté acoustique. Nous espérons qu'il apportera richesse et fiabilité à chaque son que vous vivrez. Bienvenue dans la famille BAT.

DE

Vielen Dank, dass Sie sich für BAT entschieden haben.

Ihr Vertrauen in unser Engagement für klangliche Präzision und durchdachtes Design bedeutet uns sehr viel. Jedes BAT-Produkt ist das Ergebnis rigoroser Ingenieurskunst, sorgfältiger Handwerkskunst und eines unermüdlichen Strebens nach akustischer Klarheit. Wir hoffen, dass es jedem Ihrer Klangerlebnisse Reichtum und Zuverlässigkeit verleiht. Willkommen in der BAT-Familie.

IT

Grazie per aver scelto BAT.

La sua fiducia nel nostro impegno per la precisione sonora e il design mirato è per noi di grande valore. Ogni prodotto BAT è il risultato di un'ingegneria rigorosa, di una lavorazione artigianale accurata e di una costante ricerca della chiarezza acustica. Ci auguriamo che porti ricchezza e affidabilità a ogni suono che ascolta. Benvenuto nella famiglia BAT.

JP

BAT をお選びいただきありがとうございます。

音の精度と意図的なデザインへの私たちの取り組みに対するあなたの信頼は、私たちにとって非常に重要です。BAT の各製品は、厳密なエンジニアリング、丁寧なクラフトマンシップ、そして音響の明瞭さへの絶え間ない追求の成果です。

それがあなたのすべての音の体験に豊かさや信頼性をもたらすことを願っています。BAT ファミリーへようこそ。

AR

شكرًا لاختيارك BAT.

إن ثقتك في التزامنا بالدقة الصوتية والتصميم المدروس تعني لنا الكثير. كل منتج من BAT هو نتيجة لهندسة دقيقة، وحرفية متقنة، وسعي لا يكل لتحقيق وضوح صوتي فائق. نأمل أن يضيف هذا المنتج ثراءً وموثوقية لكل تجربة استماع تخوضها. مرحبًا بك في عائلة BAT.

Acknowledgments

SP

Gracias por elegir BAT.

Su confianza en nuestro compromiso con la precisión sonora y el diseño intencionado significa mucho para nosotros. Cada producto de BAT es el resultado de una ingeniería rigurosa, una artesanía cuidadosa y una búsqueda incansable de claridad acústica. esperamos que aporte riqueza y fiabilidad a cada sonido que experimente. Bienvenido a la familia BAT.

RU

Благодарим вас за выбор BAT.

Ваше доверие к нашему стремлению к звуковой точности и продуманному дизайну очень важно для нас. Каждый продукт BAT результат строгой инженерии, тщательного мастерства и неустанного стремления к акустической ясности.

Мы надеемся, что он принесет богатство и надежность в каждое ваше звуковое впечатление. Добро пожаловать в семью BAT.

CN

感谢您 BAT。

您我在声音精度和有目的方面承的信任我意重大。每一款BAT品都是工程、精心工和音响清晰度不懈追求的晶。

我希望它能您的每一次聆听体来丰富和可靠。迎加入BAT大家庭。

PT

Obrigado por escolher a BAT.

A sua confiança no nosso compromisso com a precisão sonora e o design intencional significa muito para nós. Cada produto BAT é o resultado de engenharia rigorosa, artesanato cuidadoso e uma busca incessante pela clareza acústica.

Esperamos que ele traga riqueza e confiabilidade a cada som que você experimente. Bem-vindo à família BAT.

TR

BAT'ı seçtiğiniz için teşekkür ederiz.

Ses hassasiyeti ve amaçlı tasarıma olan bağlılığımıza duyduğunuz güven bizim için çok değerlidir. Her BAT ürünü, titiz mühendislik, özenli işçilik ve akustik netliğe yönelik amansız bir arayışın sonucudur.

Bu ürünün, yaşadığınız her ses deneyimine zenginlik ve güvenilirlik katmasını umuyoruz. BAT ailesine hoş geldiniz.

HI

BAT चुनने के लिए धन्यवाद।

ध्वनि की सटीकता और उद्देश्यपूर्ण डिज़ाइन के प्रति हमारी प्रतिबद्धता में आपके विश्वास का हमारे लिए बहुत महत्व है। प्रत्येक BAT उत्पाद कठोर इंजीनियरिंग, सावधानीपूर्वक शिल्प कौशल और ध्वनिक स्पष्टता की निरंतर खोज का परिणाम है।

हमें आशा है कि यह आपके हर श्रवण अनुभव में समृद्धि और विश्वसनीयता लाएगा। BAT परिवार में आपका स्वागत है।

What's in the Box?



User Manual

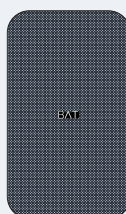

Your BAT BLOQ 4
Surface Mount Speaker

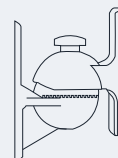

Universal Bracket

Key Features

BLOQ 4

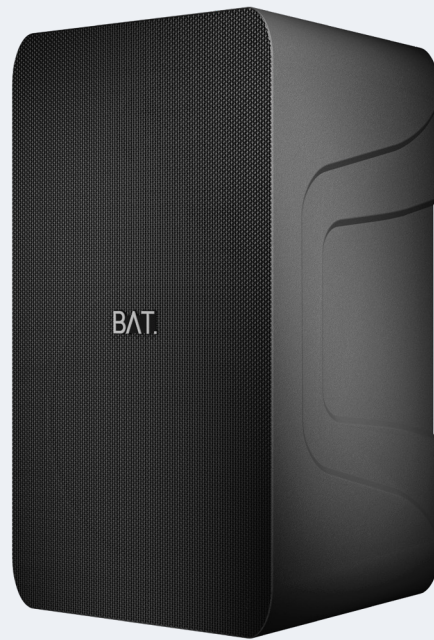

Ultimate All-Weather Sound

The **BLOQ** series is a compact all-weather speaker engineered for commercial applications. Built to deliver stunning sound quality in harsh environments, it meets the IEC529 IP55 standard with a robust ABS cabinet and flexible installation options powered by 70-100V or low-impedance.

Big Sound, Built to Weather it All

The **BLOQ** series delivers uncompromised performance as compact all-weather speakers engineered for both indoor and outdoor environments. Built to meet the IEC529 IP55 standard, they offer robust dustproof and waterproof protection while delivering stunning sound quality with clear treble and powerful bass.

Engineered for Clarity, Built for Every Space

This thoughtfully designed lineup guarantees reliable, high-fidelity audio performance in dynamic public spaces, meeting rooms, and other challenging installations.

Specs Sheet

Unit	BLOQ 4
Power Tapping:	2.5W-5W-10W-20W
Rated Power:	20W
Line Input:	70-100V/8Ω
Sensitivity:	89dB
Max Sensitivity:	105dB
Frequency Response:	90~20KHz
Dimension (DxWxH):	119x152x217mm
Material:	ABS
Weight:	2.32kg
Speaker Unit:	4" Woofer + 1" Tweeter
Colour:	White / Black
IP Rating:	IP55

Dimensions

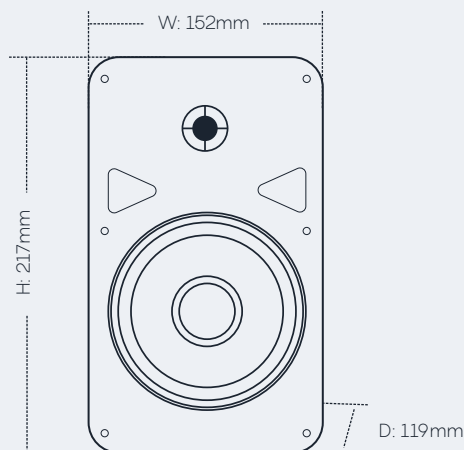

Technical Data

Frequency Response & Impedance Diagram

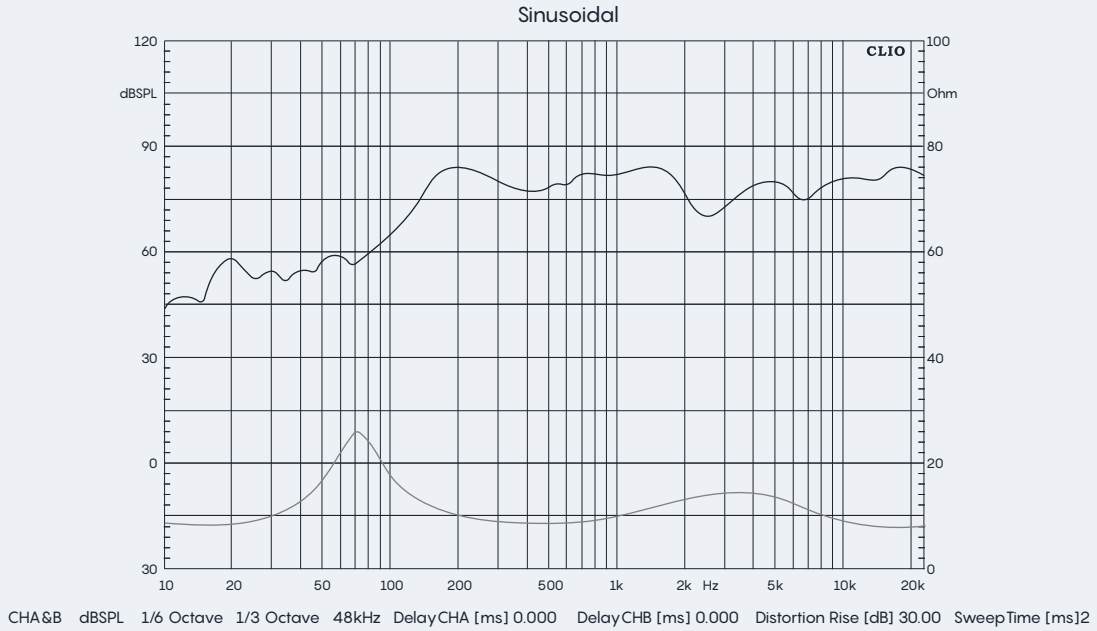

Polar Diagram

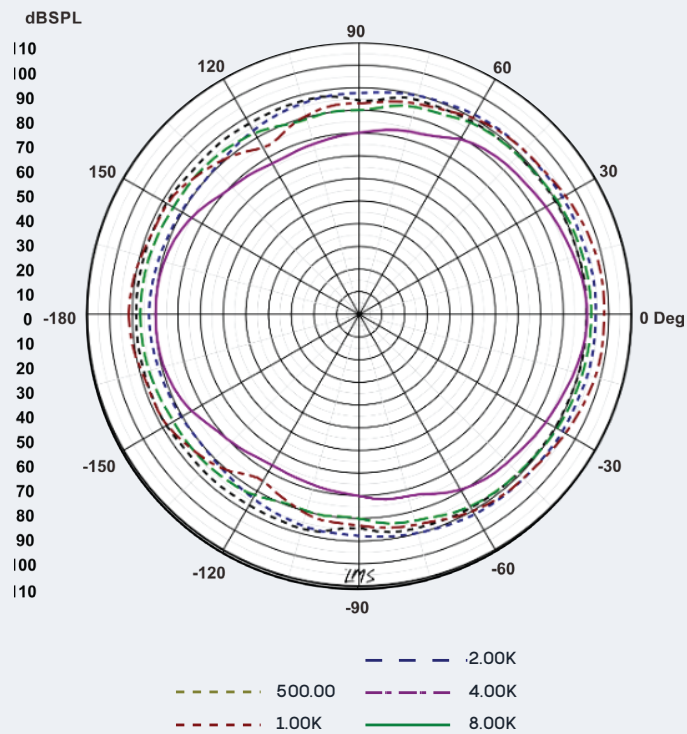

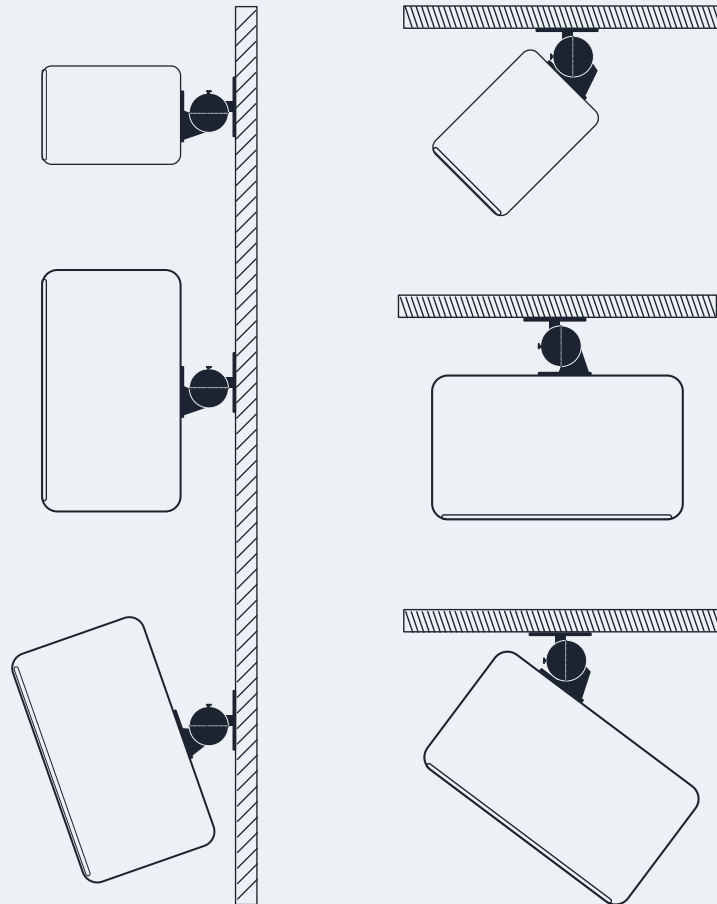

Installation Guide



Use bracket for wall-mounted or ceiling installation.

Hazard/Warning Note

	<p>The exclamation mark in an equilateral triangle alerts users to important safety instructions in the user manual. Please read carefully.</p>	
<p>1. Read these instructions. 2. Keep these instructions. 3. Heed all warnings. 4. Follow all instructions. 5. Do not use this apparatus near water. 6. Clean only with a dry cloth. 7. Do not block any ventilation openings. Install in accordance with the manufacturer's instructions. 8. Do not install near any heat sources such as radiators, heat registers, stoves, or other apparatus (including amplifiers) that produce heat. 9. Do not defeat the safety purpose of the polarized or grounding-type plug. A polarized plug has two blades with one wider than the other. A grounding type plug has two blades and a third grounding prong. The wide blade or the third prong are provided for your safety. If the provided plug does not fit into your outlet, consult an electrician for replacement of the obsolete outlet. 10. Protect the power cord from being walked on or pinched, particularly at plugs, convenience receptacles, and the point where they exit from the apparatus.</p> 	<p>11. Only use attachments/accessories specified by BAT. 12. Use only with the cart, stand, tripod, bracket, or table specified by the manufacturer, or sold with the apparatus. When a cart is used, use caution when moving the cart/apparatus combination to avoid injury from tip-over. 13. Unplug this apparatus during lightning storms or when unused for long periods of time. 14. Refer all servicing to qualified service personnel. Servicing is required when the apparatus has been damaged in any way, such as power-supply cord or plug is damaged, liquid has been spilled or objects have fallen into the apparatus, the apparatus has been exposed to rain or moisture, does not operate normally, or has been dropped. 15. Never introduce objects into the vents of the device. Doing so may contact high-voltage components or cause a short circuit, leading to fire or electric shock. Keep liquids away from the device. 16. Do not attempt to repair this device yourself. Opening the device can expose you to high voltages and other risks. For all</p>	<p>maintenance or repairs, contact qualified professionals. 17. Replacement Components: When replacement parts are required, be sure the service technician uses replacement parts specified by the manufacturer or have the same characteristics as the original part. Unauthorized substitutions may result in fire, electric shock, or other hazards. 18. Safety Check: Upon completion of any service or repairs to this device, ask the service technician to perform safety checks to determine that the device is in proper operating condition. 19. This appliance shall not be exposed to dripping or splashing water and that no object filled with liquids, such as vases, shall be placed on the apparatus. 20. In order to avoid damaging your hearing, do not listen to loudspeakers at high volumes for extended periods. Listening to speakers at high volumes can damage the user's ears and may lead to hearing problems. 21. Exposure to excessive volumes (over 85dB) for more than one hour can cause irreparable damage to your hearing.</p> 

Warranty

Your **BAT Speaker** is accompanied by a separate warranty document outlining the specific terms and conditions of your coverage.

Please refer to this document for detailed information regarding the duration of the warranty, what is covered, and the process for making a claim. We recommend retaining your proof of purchase along with the warranty document for convenient reference. For any warranty-related inquiries, please contact your authorized BAT dealer or reach out to us directly using the contact information provided in this manual."

Disclaimer

Information contained in this manual is subject to change without prior notice and does not represent a commitment on the part of the vendor. We shall not be liable for any loss or damages whatsoever arising from the use of information or any error contained in this manual.

It is recommended that all services and repairs on this product be carried out by us or its authorized dealer.

This product must only be used for the purpose it was intended by the manufacturer and in conjunction with this operating manual.

We cannot accept any liability whatsoever for any loss or damages caused by "service, maintenance or repair by unauthorized personnel" or by use other than that intended by the manufacturer.

Contact Us

info@bataudio.com
www.bataudio.com
United Kingdom

 **BAT.**
BRITISH ACOUSTIC TECHNOLOGY