

ATRIA® 20MM PORCELAIN TILES

TECHNICAL DATA SHEET



ATRIA® 20MM PORCELAIN TILES



TECHNICAL DATA SHEET



Atria® Porcelain Tiles

Find out more or request a sample

Email sales@raftsystems.com or visit raftsystems.com

© 2025 Raft® Ltd. At the time of writing and publication of the sheet, all information is specified correctly. The company reserves the right to change the specifications of this product at any time without prior notice to third parties. Any images and diagrams used in this sheet are intended only as illustrations. No rights can be derived from them.

Ref: **DS-AM-1223** Last update: August 2025

ATRIA® 20MM PORCELAIN TILES



TECHNICAL DATA SHEET

Stone

RANGE	COLOUR	PRODUCT CODE & SIZES						
		600x600	450x900	600x900	600x1200	1200x1200	1200x2400	300x600
Asti	Carbon	410010	-	-	410015	-	-	-
	Mushroom	410011	-	-	410016	-	-	-
	Smoke	410012	-	-	410017	-	-	-
	Talc	410013	-	-	410018	-	-	-
	Taupe	410014	-	-	410019	-	-	-
Florence	Graphite	402013	402011	-	-	402015	402018	-
	Millstone	402014	402010	-	-	402016	402020	-
	Silver	402030	402025	-	-	402017	402022	-
Modena	Ivory	*	-	-	407023	-	-	407021*
	Smoke	*	-	-	407025	-	-	407022*
	String	*	-	-	407024	-	-	407020*
Modica	Pewter	415012	-	-	-	-	-	-
	Silver	415013	-	-	-	-	-	-
Novara	Ashen	-	-	461107	-	-	-	-
	Cameo	-	-	461101	-	-	-	-
	Ember	-	-	461104	-	-	-	-
	Slate	-	-	461110	-	-	-	-
Roma	Earth	404026	404013	-	-	-	-	-
	Lead	404027	404014	-	404017	404038	404042	-
	Natural	404029	404015	-	404018	404039	-	-
Taranto	Charcoal	408025	408028	-	-	-	-	-
	Hessian	408024	408029	-	-	-	-	-
	Steel	408023	408026	-	-	-	-	-
Lucca	Pearl	419005*	-	-	419001	-	-	-
	Ivory	419006*	-	-	419002	-	-	-
	Beige	419007*	-	-	419003	-	-	-
	Grey	419008*	-	-	419004	-	-	-

* On request

Find out more or request a sample

Email sales@raftsystems.com or visit raftsystems.com

ATRIA® 20MM PORCELAIN TILES

TECHNICAL DATA SHEET



Concrete

RANGE	COLOUR	PRODUCT CODE & SIZES			
		300x600	600x600	900x900	1200x1200
Pavia	Cloud	-	416010	-	416014
	Urban	416018*	416012	-	416015
	Shadow	-	416013	-	-
Venice	Anthracite	-	406011	-	406021
	Beige	-	406012	-	-
	Grey	-	406013	-	406019
	Mocha	-	406014	-	406020

* On request

Terrazzo

RANGE	COLOUR	PRODUCT CODE & SIZES	
		600x600	1200x1200
Padua	Thunder	417010	417011

For LRV ratings please reach out to a member of the team.

Find out more or request a sample

Email sales@raftsystems.com or visit raftsystems.com

ATRIA® 20MM PORCELAIN TILES



TECHNICAL DATA SHEET

Packaging and weights

TILE SIZE	THICKNESS	BOX SPECIFICATION			PALLET SPECIFICATION		
		PIECES/ BOX	SQM/ BOX	Kg/ BOX	TILES/ PALLET	SQM/ PALLET	Kg/ PALLET
300 x 1200	20mm	2	0.72	≈33.05	72	25.92	≈1203
600 x 600	20mm	2	0.72	≈30.70	60	21.60	≈934
450 x 900	20mm	2	0.81	≈37.40	54	21.87	≈1028
600 x 900	20mm	2	1.08	≈48.50	48	25.92	≈1182
600 x 1200	20mm	1	0.72	≈33.77	35	25.20	≈1202
900 x 900	20mm	1	0.81	≈38.00	36	14.58	≈699
1200 x 1200	20mm	1	1.43	≈67.10	20	28.56	≈1377
1200 x 2400	20mm	1	2.86	≈134.20	9	25.70	≈1303

Working size and weights

TILE SIZE	ACTUAL RECTIFIED SIZE	M ² /TILE	KG/TILE
600 x 600	596 x 596	0.3600	≤16.53
600 x 900	596 x 895	0.5400	≤24.25
300 x 1200	297 x 1195	0.3600	≤16.53
600 x 1200	596 x 1195	0.7200	≤33.77

Find out more or request a sample

Email sales@raftsystems.com or visit raftsystems.com

ATRIA® 20MM PORCELAIN TILES



TECHNICAL DATA SHEET

Slip resistance

TECHNICAL FEATURES	SPECIFICATION	VALUES REQUIRED	ATRIA® VALUES
Dynamic slider	BCRA	Test method available	>0.4
Static slider	ASTM C1028	Test method available	-
Inclined platform	DIN 51130	Test method available	R11
Pendulum test value (PTV) - dry	BS EN 14231	36+	72
Pendulum test value (PTV) - wet	BS EN 14231	36+	65

Uniformly distributed load (UDL) testing TO BS EN 1991-1-1:2002

	LOAD VALUE
RaafT Preventa System incorporating Atria Porcelain Tiles	30.36 kN/m ² (kPa)
RaafT Preventa System incorporating Farrino Porcelain Tiles	30.03 kN/m ² (kPa)

Point load tests TO BS EN 1991-1-1:2002

	MEAN LOAD VALUE
RaafT Preventa System incorporating Atria Porcelain Tiles	7.02 kN***
RaafT Preventa System incorporating Farrino Porcelain Tiles	6.32 kN***

*** Prior to failure by way of the tile cracking

Find out more or request a sample

Email sales@raaftsystems.com or visit raaftsystems.com

ATRIA® 20MM PORCELAIN TILES



TECHNICAL DATA SHEET

Regularity characteristics

TECHNICAL FEATURES	SPECIFICATION	VALUES REQUIRED		ATRIA® VALUES
Length and width	UNI EN ISO 10545-2	±0.3%	±1mm	Compliant
Thickness	UNI EN ISO 10545-2	±5.0%	±0.5mm	Compliant
Squareness	UNI EN ISO 10545-2	±0.3%	±1.5mm	Compliant
Straightness of sides	UNI EN ISO 10545-2	±0.3%	±0.8mm	Compliant
Surface flatness	UNI EN ISO 10545-2	±0.4%	±1.8mm	Compliant

Structural characteristics

TECHNICAL FEATURES	SPECIFICATION	VALUES REQUIRED		ATRIA® VALUES
Water absorption	UN EN ISO 10545-3	≤0.5%		≤0.1%
	ASTM C373			In accordance
Breaking strength	UN EN ISO 10545-4	≥1300N		≥10,000N
Modulus of rupture	UN EN ISO 10545-4	≥35mm ³		Compliant

Surface characteristics

TECHNICAL FEATURES	SPECIFICATION	VALUES REQUIRED		ATRIA® VALUES
Resistance to deep abrasion	UN EN ISO 10545-6	≤175mm ³		≤155mm ³

Thermal and hygrometric characteristics

TECHNICAL FEATURES	SPECIFICATION	VALUES REQUIRED		ATRIA® VALUES
Coefficient of linear thermal expansion	UN EN ISO 10545-8	Test method available		Test method available
Thermal shock resistance	UN EN ISO 10545-9	Resistant		Compliant
Frost resistance	UN EN ISO 10545-12	Resistant		Compliant

Chemical characteristics

TECHNICAL FEATURES	SPECIFICATION	VALUES REQUIRED		ATRIA® VALUES
Chemical resistance	UN EN ISO 10545-13	Resistant		Compliant
Stain resistance	UN EN ISO 10545-14	Resistant		Compliant

Find out more or request a sample

Email sales@raftsystems.com or visit raftsystems.com

ATRIA® 20MM PORCELAIN TILES



TECHNICAL DATA SHEET

Natural Stone

LIMESTONE



Natural Beige Brushed Beige Brushed White Beige Etched

BASALT

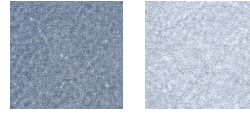

Flamed Black Flamed Grey

SALT

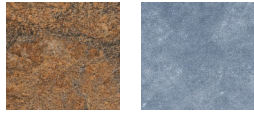

Slate Rustic Slate Grey

GRANITE

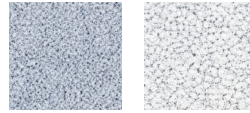

Grey White

STONE

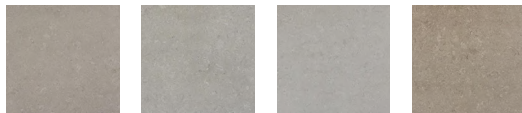

Lucca Ivory Lucca Grey Lucca Pearl Lucca Beige



Novara Slate Novara Ember Novara Cameo Novara Ashen

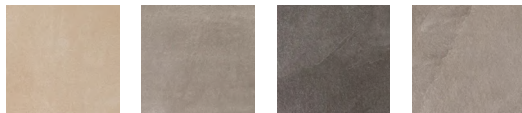

Asti Talc Asti Smoke Asti Carbon Asti Mushroom



Asti Taupe Modena Ivory Modena Smoke Modena String

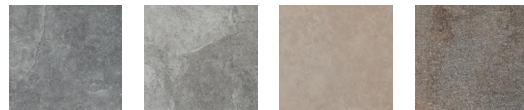

Traranto Charcoal Traranto Steel Traranto Hessian Florence Milestone

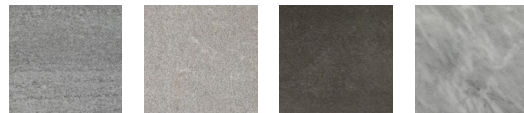

Florence Graphite Florence Silver Modica Pewter Modica Silver

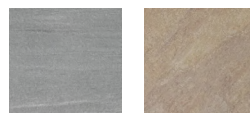

Roma Lead Roma Natural

Concrete

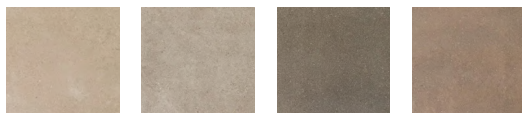

Venice Beige Venice Grey Venice Anthracite Venice Mocha



Pavia Cloud Pavia Urban

Terrazzo

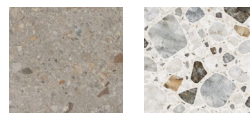

Padua Thunder Natural

Find out more or request a sample

Email sales@raftsystems.com or visit raftsystems.com

ATRIA® 20MM PORCELAIN TILES



TECHNICAL DATA SHEET

Installation information

Refer to the install guide for further information.

Sustainability

Atria® porcelain tiles are made by pressing and baking a mix of natural minerals and clays. This process creates strong and long-lasting tiles. Unlike many other materials, these tiles are eco-friendly. They don't soak up harmful chemicals or release contaminants. They're also easy to clean without needing strong chemicals.

Product maintenance

Our Atria® tiles are easy to clean and resist most chemicals. They're UV stable and only have 0.01% porosity. It's a good idea to clean them once or twice a year, depending on local weather conditions. Use a high-pressure cleaner from at least 20cm away or scrub with a mild all-purpose cleaner and water. For daily cleaning, just sweep regularly and rinse with water, a soft brush, and a mild cleaner or suds.

Protective equipment

- a) **Good strong safety boots/shoes to protect the feet.**
- b) **Protective eyewear such as safety glasses.**
- c) **Strong gloves to protect the hands.**
- d) **If using loud cutting equipment then ear plugs or defenders should be worn.**

Storage and handling

In preparation for delivery, Atria® tiles are securely packed into cardboard boxes to ensure no movement during transit.

Depending on the size and weight of the consignment they may be palletised. Until the point of installation, the tiles should be stored fully packed in a dry environment.

Fire rated

Fire rated in accordance with BS EN 13501-1 to achieve a BROOF(t4) classification. Consult our certification documents for verification.

Find out more or request a sample

Email sales@raftsystems.com or visit raftsystems.com

ATRIA® 20MM PORCELAIN TILES



TECHNICAL DATA SHEET

Accessories

Venice clip

Our product stemmed from valuable feedback received from a domestic building grappling with water pooling issues on their porcelain tiles. After meticulous contemplation and design efforts spanning several months, the solution was crafted.

The predicament of water pooling takes on greater significance with the introduction of new materials to the UK market. Despite tiles boasting ratings of R11 or higher, the accumulation of water transforms into ice during winter, prompting the exclusion of porcelain from specifications on roof terraces nationwide.

Enter our innovative product, poised to address this challenge effectively. Raft® now offers a solution enabling water drainage from tiles within a precise 1-hour timeframe, aligning seamlessly with NHBC 9.1.15 guidelines. According to these standards, standing water post-rain should neither exceed 5mm in depth nor cover an area surpassing 1m².

We prioritise subtlety, employing transparent materials potentially matching Raft®'s specified tiles. The Venice clip is designed to break the surface tension of the tile, similar to a grout joint where porcelain tiles are installed on cement. When porcelain is installed onto a loose laid system the joints are exposed which means the files fill with water due to surface tension.

The product is flush to the surface reducing the chances of feet being caught.

During installation, especially in wind uplift scenarios, our design incorporates a clip securely inserted into the groove. This not only ensures a snug fit but also acts as a protective 'buffer' between tiles, facilitating removal and reinstallation without compromising structural integrity.

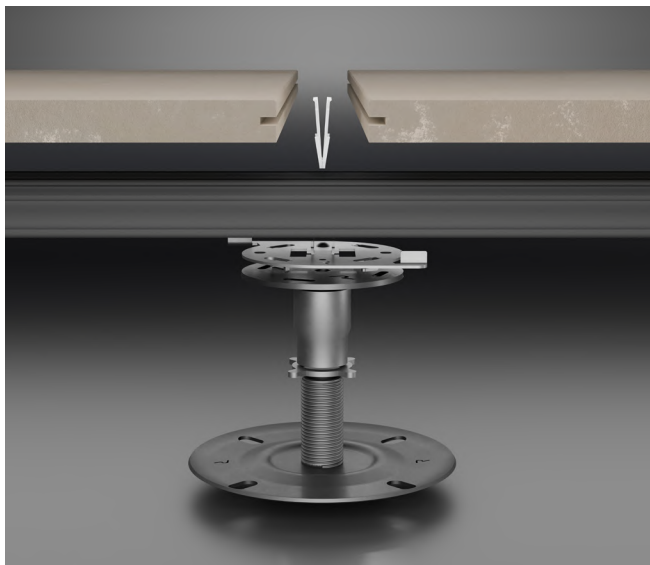

Venice Clip Push – this item serves as a universal solution for all porcelain within the RAAFT® collection.

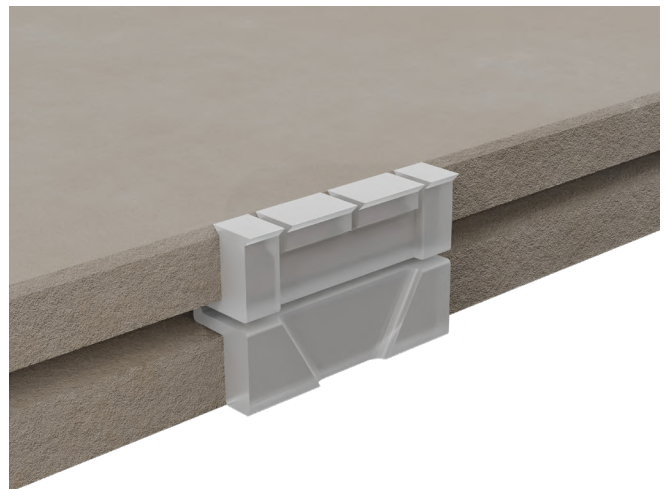

Venice Clip Uplift

Find out more or request a sample

Email sales@raftsystems.com or visit raftsystems.com

ATRIA® 20MM PORCELAIN TILES



TECHNICAL DATA SHEET

Wind uplift

This product has been tested and complies with BS EN 1991-1-4:2005+A1:2010. Please consult our certification for verification.



Step Dimensions

Step dimensions: 900 × 450 × 150 and 120 × 450 × 150.

Please contact us if you require different sizes.

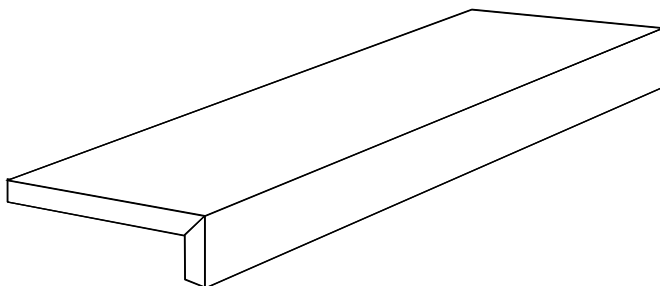

Find out more or request a sample

Email sales@raftsystems.com or visit raftsystems.com