



SFK 30 C

Safety lamella-basket plug

Ø 4mm Safety

1.000 V CAT II

32 A

- straight, with crimp terminal for cables 2.5 mm²
- with sleeve, unassembled
- Caution! The function of crimped insulation is only warranted when cable LTG 2.5 (see chapter Cables) is used.

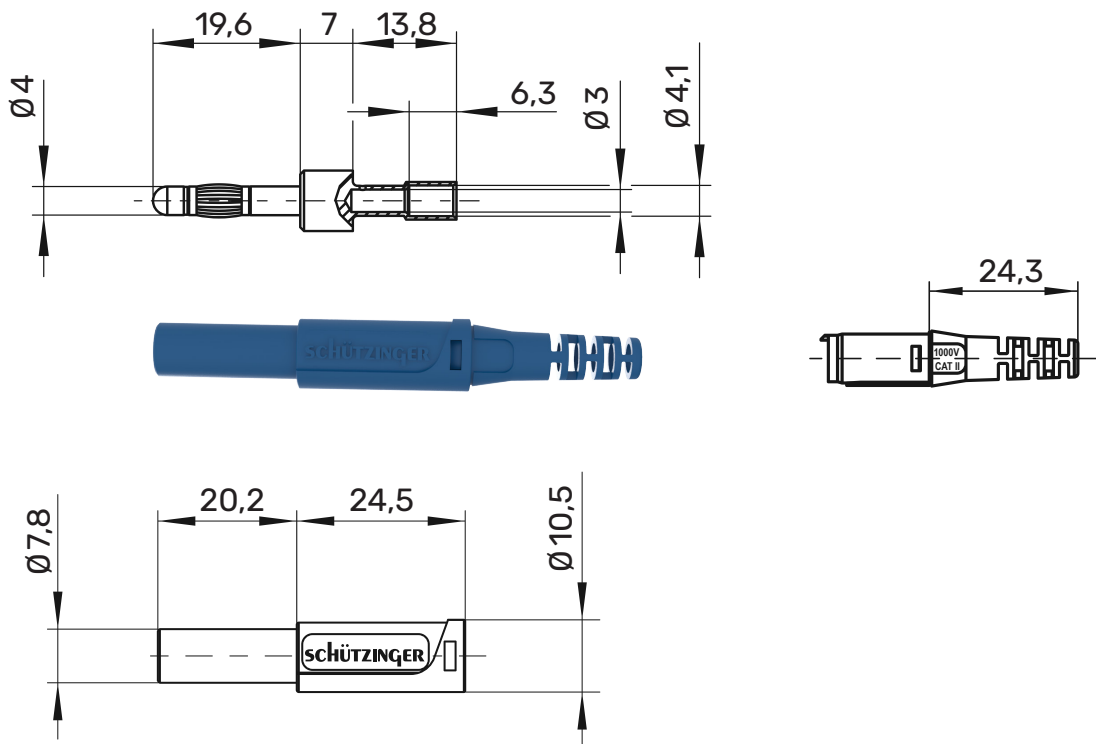

General information

Order No. ¹⁾	SFK 30 C Ni Au /OK ..(colours)
colours	black, red, blue, yellow, green, grey, brown, white, purple, green-yellow
contact parts	nickel-plated gold-plated
sleeves	PA 6.6 (Polyamid)

Technical data











terminal	crimp 2,5 mm ²
sleeve for cable	Ø 4 mm
for wire cross-section	bis 2,5 mm ²
for cable diameter	4 mm
transition resistance	3 mΩ (Ni) 2 mΩ (Au)
rated voltage ²⁾	1000 V CAT II
rated current ²⁾	32 A
operating temperature	von -25 °C bis +80 °C

¹⁾ other contact platings, colours and sleeves for other cable diameter on request
²⁾ at normal ambient temperatures

SFK 30 C

Ni

Au

	SW	Schwarz	Black	99009978	99015651
	RT	Rot	Red	99015431	99015652
	BL	Blau	Blue	99015432	99015653
	GE	Gelb	Yellow	99015433	99015654
	GN	Grün	Green	99015644	99015655
	GR	Grau	Grey	99015646	99015656
	BR	Braun	Brown	99015647	99015727
	WS	Weiß	White	99015648	99015658
	VI	Violett	Purple	99015649	99015659
	GNGE	Grüngelb	green-yellow	99015650	99015660