



SAK 6716

Safety crocodile clip

Ø 4 mm safety

600 V CAT II

10 A

- insulated
- socket Ø 4 mm
- contact: crocodile jaws

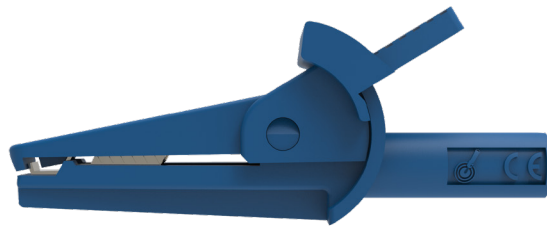
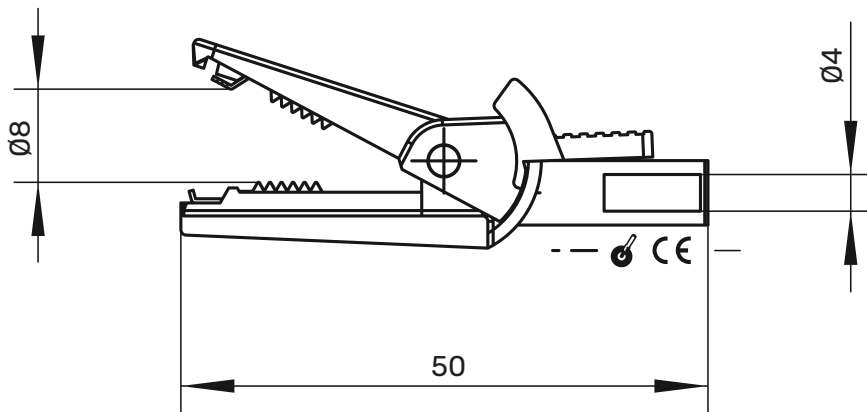

General information

Order No. ¹⁾	SAK 6716 Ni
colour	black, red, blue, yellow, green, white
contact parts	nickel-plated
insulation	PA 6.6 (Polyamid)





Technical data

terminal	safety socket
grips up to	Ø 8 mm
transition resistance	15 mΩ (Ni)
rated voltage ²⁾	600 V CAT II
rated current ²⁾	10 A
operating temperature	from -25 °C to +80 °C

¹⁾ other colours on request
²⁾ at normal ambient temperatures

SAK 6716

Ni

	SW	Schwarz	Black	99013315
	RT	Rot	Red	99013316
	BL	Blau	Blue	99013477
	GE	Gelb	Yellow	99013478
	GN	Grün	Green	99013479
	WS	Weiß	White	99013480