



ESD 498

Quick-release terminal

Ø 4mm

30 V_{AC} / 60 V_{DC}

16 A

- fully insulated for metal panels

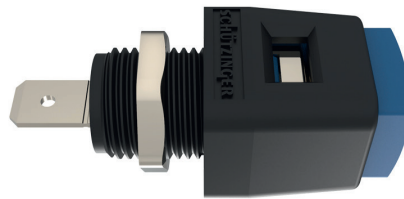
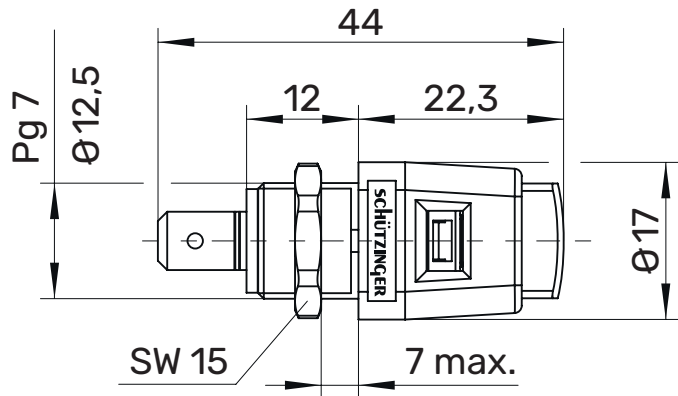

Hole

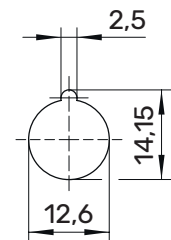

General information

Order No. ¹⁾	ESD 498 / ..(Farbe)
Colours	black, red, blue, yellow, green, grey, brown, white, orange, purple, green-yellow
Contact parts	nickel-plated
Insulation	PA6.6 (Polyamid)











Technical data

terminal	FSH 6,3 x 0,8 oder Lötten
transition resistance	5 mΩ
rated voltage ²⁾	30 V _{AC} / 60 V _{DC}
rated current ²⁾	16 A
operating temperature	von -25 °C bis +90 °C
max. torque fastening nut	45 Ncm
panel thickness	0,8 - 7 mm
tab	6,3 x 0,8 mm
front insertion window	6,5 x 4 mm
rear insertion window	6,5 x 4 mm
spring force	20 N

¹⁾ other colours, terminals and springs (approx. 15 N or 33 N) on request

²⁾ at normal ambient temperatures

ESD 498**Ni**

 SW	Black	99000647
 RT	Red	99000644
 BL	Blue	99007728
 GE	Yellow	99007962
 GN	Green	99007963
 GR	Grey	99016203
 BR	Brown	99008880
 WS	White	99008883
 VI	Purple	99016204
 OR	Orange	99016205
 GNGE	Green-Yellow	99007729