



SAB 6922

Sicherheits-Aufbaubuchse

Ø 4mm Sicherheit

1.000 V CAT III

32 A

- zum Einbauen in Frontplatten bis 6 mm Dicke
- Befestigung mittels einer Schlitzmutter M12 x 0,75 und einer Federscheibe
- Montagebohrung Ø 12,1 mm

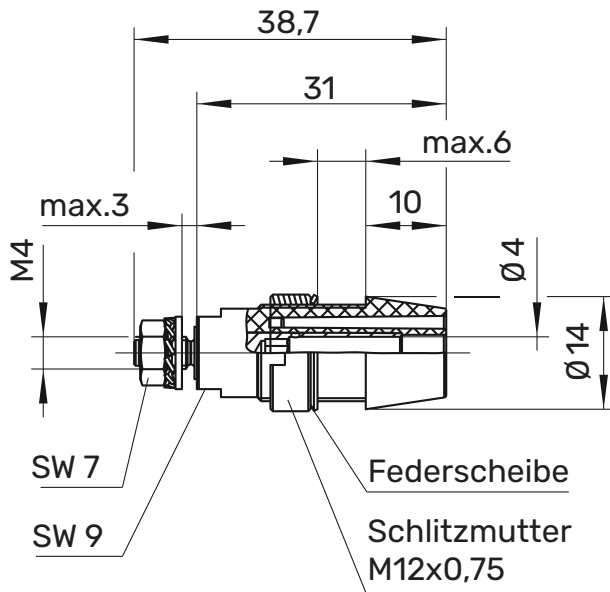

⚠ WH 005



Allgemeine Angaben

Best.-Nr. ¹⁾	SAB 6922 Ni Au / ..(Farbe)
Farben	schwarz, rot, blau, gelb, grün, grau, braun, weiß, violett, grüngelb
Kontaktteile	vernickelt vergoldet
Isolierteile	PA6.6 (UL94-V2)

Technische Daten

Anschluss	M4
Durchgangswiderstand	7 mΩ (Ni) 5 mΩ (Au)
Bemessungsspannung ²⁾	1000 V CAT III
Bemessungsstrom ²⁾	32 A
Betriebstemperatur	von -25 °C bis +80 °C
Anzugsdrehmoment	45 Ncm
der Befestigungsmutter	

SCHÜTZINGER











¹⁾ andere Kontaktflächen, Farben und Anschlüsse auf Anfrage

²⁾ bei normalen Umgebungstemperaturen

SAB 6922

Ni

Au

	SW	Schwarz	Black	99014109	99014096
	RT	Rot	Red	99014110	99013845
	BL	Blau	Blue	99014111	99014097
	GE	Gelb	Yellow	99014112	99014098
	GN	Grün	Green	99014113	99014099
	GR	Grau	Grey	99014114	99013797
	BR	Braun	Brown	99016186	99016183
	WS	Weiß	White	99016187	99015168
	VI	Violett	Purple	99014115	99013798
	GNGE	Grüngelb	green-yellow	99015133	99015132