



SEB 6445

Sicherheits-Einbaubuchse

Ø 4mm Sicherheit

1000 V CAT III

32 A

- zum Einbauen in Frontplatten bis 6 mm Dicke
- Befestigung mittels einer Schlitzmutter M12 x 0,75 und einer Federscheibe
- Montagebohrung Ø 12,2+0,1 mm
- Montage mittels Montagewerkzeug MWZ 8 und MWZ 15
- Befestigungsmutter (Schlitzmutter) M12 x 0,75

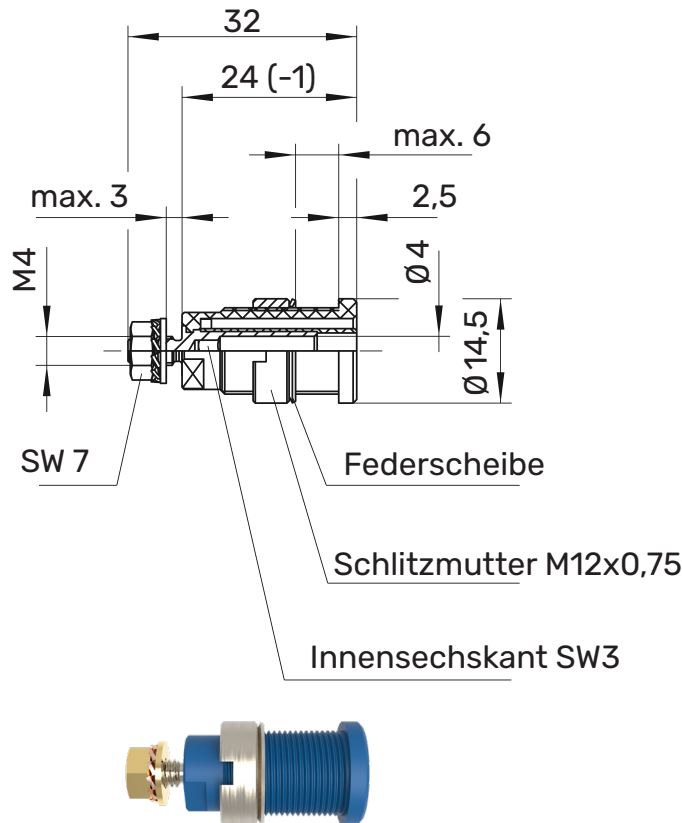

! WH 005



MA 007













Allgemeine Angaben

Best.-Nr. ¹⁾	SEB 6445 Ni Au / ..(Farbe)
Farben	schwarz, rot, blau, gelb, grün, grau, braun, weiß, orange, violett, grüngelb
Kontaktteile	vernickelt vergoldet
Isolierteil	PA 6.6 (Polyamid) UL94 - V2

Technische Daten

Anschluss	M4
Durchgangswiderstand	7 mΩ (Ni) 5 mΩ (Au)
Bemessungsspannung ²⁾	1000 V CAT III
Bemessungsstrom ²⁾	32 A
Betriebstemperatur	von -25 °C bis +80 °C
Anzugsdrehmoment der Befestigungsmutter	45 Ncm
Anzugsdrehmoment der Mutter M4	100 Ncm

¹⁾ andere Kontaktoberflächen, Farben und Anschlüsse auf Anfrage
²⁾ bei normalen Umgebungstemperaturen

SEB 6445				Ni	Au
	SW	Schwarz	Black	99014157	99020646
	RT	Rot	Red	99014637	99014978
	BL	Blau	Blue	99014638	99017577
	GE	Gelb	Yellow	99014639	99021050
	GN	Grün	Green	99014640	99012738
	GR	Grau	Grey	99014641	99014980
	BR	Braun	Brown	99018338	99021093
	WS	Weiß	White	99012731	99018805
	VI	Violett	Purple	99012732	99014697
	OR	Orange	Orange	99022435	-
	GNGE	Grüngelb	green-yellow	99014642	99016727