



SEB 6445

Safety threaded socket

Ø 4mm Safety

1000 V CAT III

32 A

- for fixture in panels up to 6 mm thick
- fixed by: slotted nut M12 x 0.75 and spring washer
- hole Ø 12.2+0.1 mm
- fixture using special tools MWZ 8 and MWZ 15
- fastening nut (slotted nut) M12 x 0.75

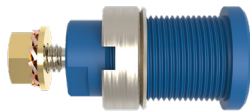
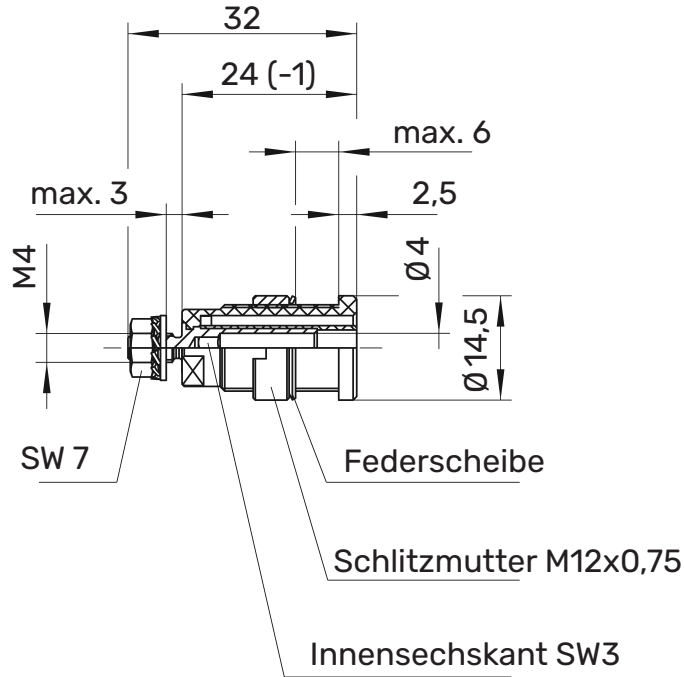

! WH 005



MA 007













General information

| | |
|-------------------------|---|
| Order No. ¹⁾ | SEB 6445 Ni Au / ..(colour) |
| colour | black, red, blue, yellow, green, grey, brown, white, orange, purple, green-yellow |
| contact parts | nickel-plated gold-plated |
| insulation | PA 6.6 (Polyamid) UL94 - V2 |

Technical data

| | |
|-----------------------------|-----------------------|
| terminal | M4 |
| transition resistance | 7 mΩ (Ni) 5 mΩ (Au) |
| rated voltage ²⁾ | 1000 V CAT III |
| rated current ²⁾ | 32 A |
| operating temperature | from -25 °C to +80 °C |
| max. torque | 45 Ncm |
| fastening nut | |
| max. torque | 100 Ncm |
| nut M4 | |

¹⁾ other contact platings, colours and terminals on request
²⁾ at normal ambient temperatures

| SEB 6445 | | | | Ni | Au |
|---|-------------|-----------------|---------------------|-----------|-----------|
|  | SW | Schwarz | Black | 99014157 | 99020646 |
|  | RT | Rot | Red | 99014637 | 99014978 |
|  | BL | Blau | Blue | 99014638 | 99017577 |
|  | GE | Gelb | Yellow | 99014639 | 99021050 |
|  | GN | Grün | Green | 99014640 | 99012738 |
|  | GR | Grau | Grey | 99014641 | 99014980 |
|  | BR | Braun | Brown | 99018338 | 99021093 |
|  | WS | Weiß | White | 99012731 | 99018805 |
|  | VI | Violett | Purple | 99012732 | 99014697 |
|  | OR | Orange | Orange | 99022435 | - |
|  | GNGE | Grüngelb | green-yellow | 99014642 | 99016727 |