



## SEB 6446

### Sicherheits-Einbaubuchse

Ø 4mm Sicherheit

1000 V CAT III

32 A

- zum Einbauen in Frontplatten bis 6 mm Dicke
- Befestigung mittels einer Schlitzmutter M12 x 0,75 und einer Federscheibe
- Montagebohrung Ø 12,2+0,1 mm
- Montage mittels Montagewerkzeug MWZ 8 und MWZ 15
- Befestigungsmutter (Schlitzmutter) M12 x 0,75

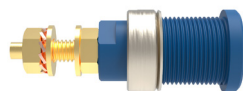
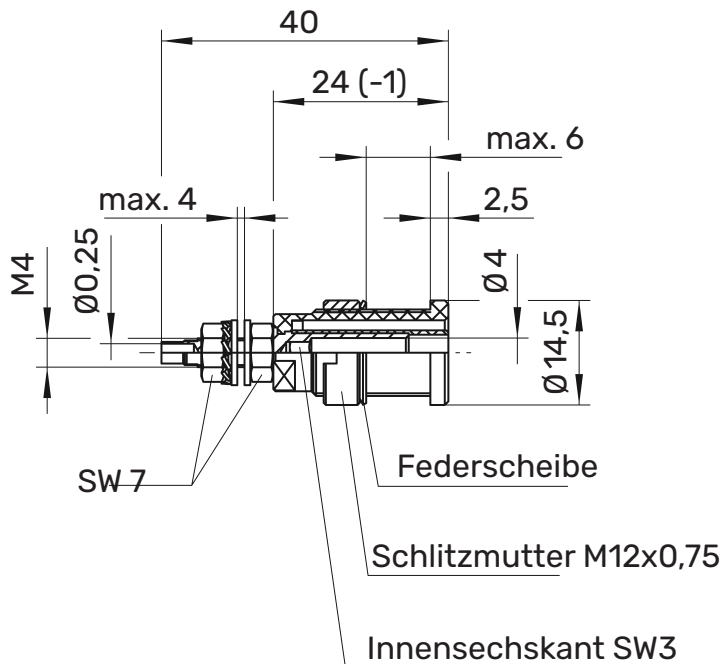

! WH 005



MA 007



### Allgemeine Angaben

Best.-Nr. <sup>1)</sup>	SEB 6446 Ni   Au / ..(Farbe)
Farben	schwarz, rot, blau, gelb, grün, grau, braun, weiß, orange, violett, grüngelb
Kontaktteile	vernickelt   vergoldet
Isolierteil	PA 6.6 (Polyamid) UL94 - V2

### Technische Daten









Anschluss	M4
Durchgangswiderstand	7 mΩ (Ni)   5 mΩ (Au)
Bemessungsspannung <sup>2)</sup>	1000 V CAT III
Bemessungsstrom <sup>2)</sup>	32 A
Betriebstemperatur	von -25 °C bis +80 °C
Anzugsdrehmoment der Befestigungsmutter	45 Ncm
Anzugsdrehmoment der Mutter M4	100 Ncm

<sup>1)</sup> andere Kontaktflächen, Farben und Anschlüsse auf Anfrage  
<sup>2)</sup> bei normalen Umgebungstemperaturen

**SEB 6446**

**Ni**

**Au**

	<b>SW</b>	<b>Schwarz</b>	<b>Black</b>	99014158	99016741
	<b>RT</b>	<b>Rot</b>	<b>Red</b>	99017485	99021213
	<b>BL</b>	<b>Blau</b>	<b>Blue</b>	99016558	99021195
	<b>GE</b>	<b>Gelb</b>	<b>Yellow</b>	99018650	99021214
	<b>GN</b>	<b>Grün</b>	<b>Green</b>	99016311	99021215
	<b>GR</b>	<b>Grau</b>	<b>Grey</b>	99018339	99018782
	<b>BR</b>	<b>Braun</b>	<b>Brown</b>	99017668	99018783
	<b>WS</b>	<b>Weiß</b>	<b>White</b>	99017004	99021216
	<b>VI</b>	<b>Violett</b>	<b>Purple</b>	99018350	99016436
	<b>OR</b>	<b>Orange</b>	<b>Orange</b>	99018497	99017939
	<b>GNGE</b>	<b>Grüngelb</b>	<b>green-yellow</b>	99016738	99016742