



SEB 6446

Safety threaded socket

Ø 4mm Safety

1000 V CAT III

32 A

- for fixture in panels up to 6 mm thick
- fixed by: slotted nut M12 x 0.75 and spring washer
- hole Ø 12.2+0.1 mm
- fixture using special tools MWZ 8 and MWZ 15
- fastening nut (slotted nut) M12 x 0.75

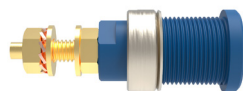
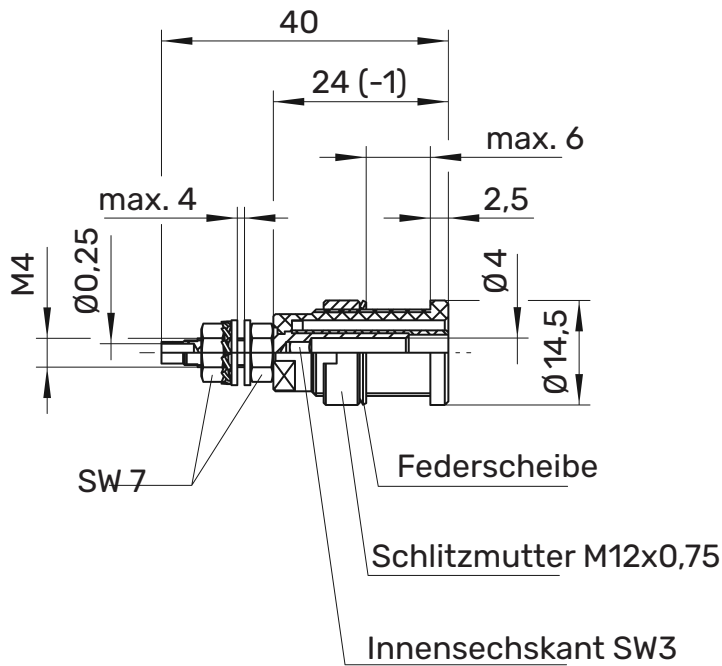

! WH 005



MA 007



General information

Order No. ¹⁾	SEB 6446 Ni Au / ..(colour)
colours	black, red, blue, yellow, green, grey, brown, white, orange, purple, green-yellow
contact part	nickel-plated gold-plated
insulation	PA 6.6 (Polyamid) UL94 - V2

Technical data











terminal	M4
transition resistance	7 mΩ (Ni) 5 mΩ (Au)
rated voltage ²⁾	1000 V CAT III
rated current ²⁾	32 A
operating temperature	from -25 °C to +80 °C
max. torque	45 Ncm
fastening nut	
max. torque	100 Ncm
nut M4	

¹⁾ other contact platings, colours and terminals on request
²⁾ at normal ambient temperatures

SEB 6446

Ni

Au

	SW	Schwarz	Black	99014158	99016741
	RT	Rot	Red	99017485	99021213
	BL	Blau	Blue	99016558	99021195
	GE	Gelb	Yellow	99018650	99021214
	GN	Grün	Green	99016311	99021215
	GR	Grau	Grey	99018339	99018782
	BR	Braun	Brown	99017668	99018783
	WS	Weiß	White	99017004	99021216
	VI	Violett	Purple	99018350	99016436
	OR	Orange	Orange	99018497	99017939
	GNGE	Grüngelb	green-yellow	99016738	99016742