



SEB 6448

Sicherheits-Einbaubuchse

Ø 4mm Sicherheit

1000 V CAT III

24 A

- zum Einbauen in Frontplatten bis 6 mm Dicke
- Befestigung mittels einer Schlitzmutter M12 x 0,75 und einer Federscheibe
- Montagebohrung Ø 12,2+0,1 mm
- Montage mittels Montagewerkzeug MWZ 8 und MWZ 15
- Befestigungsmutter (Schlitzmutter) M12 x 0,75

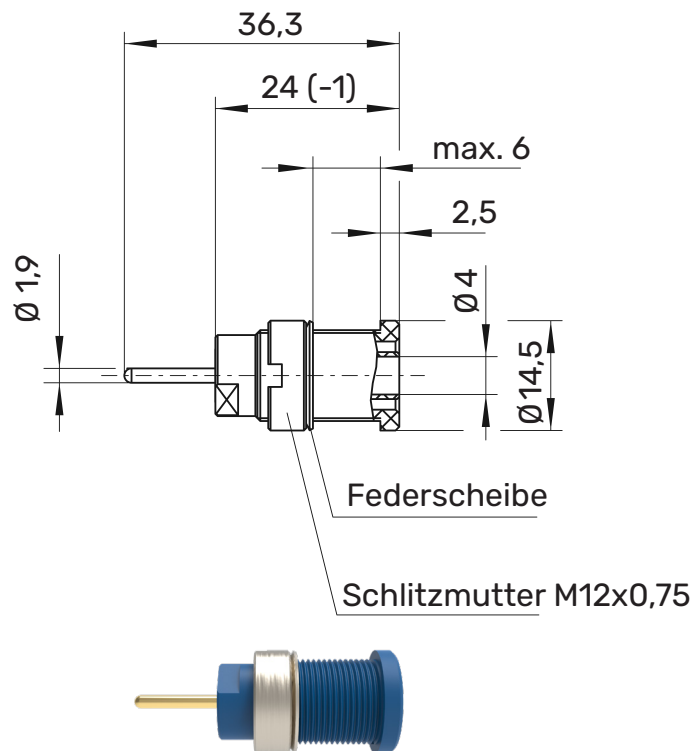

! WH 034



MA 007



Allgemeine Angaben

Best.-Nr. ¹⁾	SEB 6448 Ni Au / ..(Farbe)
Farben	schwarz, rot, blau, gelb, grün, grau, braun, weiß, orange, violett, grüngelb
Kontaktteile	vernickelt vergoldet
Isolierteil	PA 6.6 (Polyamid) UL94 - V2











Technische Daten

Anschluss	Pin Ø 1,9 mm
Durchgangswiderstand	5 mΩ (Ni) 3 mΩ (Au)
Bemessungsspannung ²⁾	1000 V CAT III
Bemessungsstrom ²⁾	24 A
Betriebstemperatur	von -25 °C bis +80 °C
Anzugsdrehmoment	45 Ncm

der Befestigungsmutter

SCHÜTZINGER

¹⁾ andere Kontaktoberflächen, Farben und Anschlüsse auf Anfrage
²⁾ bei normalen Umgebungstemperaturen

SEB 6448				Ni	Au
	SW	Schwarz	Black	99014162	99016730
	RT	Rot	Red	99018828	99020400
	BL	Blau	Blue	99021755	99017849
	GE	Gelb	Yellow	99021506	99017851
	GN	Grün	Green	99021757	99017788
	GR	Grau	Grey	99021752	99012496
	BR	Braun	Brown	99017890	99017850
	WS	Weiß	White	99019372	99017852
	VI	Violett	Purple	99021761	99012498
	OR	Orange	Orange	99021759	99020622
	GNGE	Grüngelb	green-yellow	99016732	99016733