



## SEB 6448

### Safety threaded socket

Ø 4mm Safety

1000 V CAT III

24 A

- for fixture in panels up to 6 mm thick
- fixed by: slotted nut M12 x 0.75 and spring washer
- hole Ø 12.2+0.1 mm
- fixture using special tools MWZ 8 and MWZ 15
- fastening nut (slotted nut) M12 x 0.75

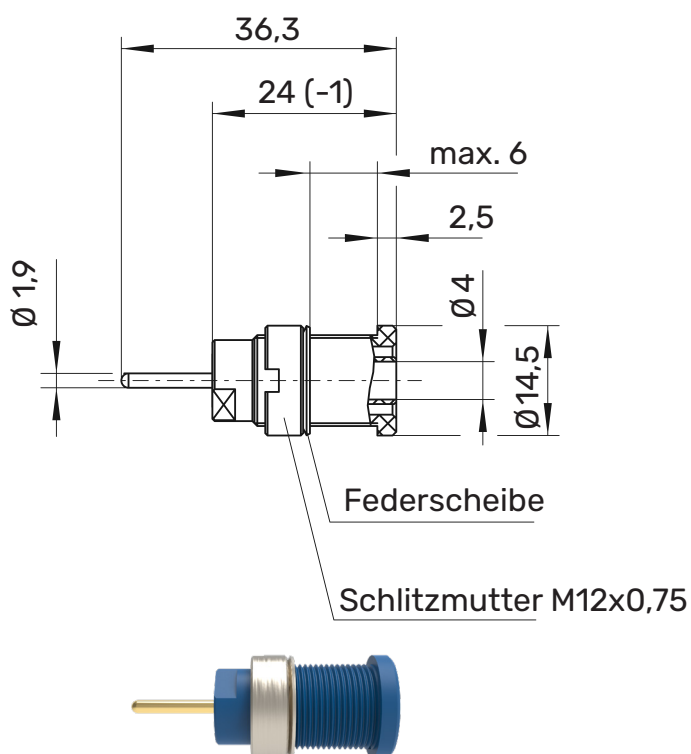

! WH 034



MA 007













#### General information

Order No. <sup>1)</sup>	SEB 6448 Ni   Au / ..(colour)
colours	black, red, blue, yellow, green, grey, brown, white, orange, purple, green-yellow
contact parts	nickel-plated   gold-plated
insulation	PA 6.6 (Polyamid) UL94 - V2

#### Technical data

terminal	Pin Ø 1,9 mm
transition resistance	5 mΩ (Ni)   3 mΩ (Au)
rated voltage <sup>2)</sup>	1000 V CAT III
rated current <sup>2)</sup>	24 A
operating temperature	from -25 °C to +80 °C
max. torque	45 Ncm
fastening nut	

<sup>1)</sup> other contact platings, colours and terminals on request  
<sup>2)</sup> at normal ambient temperatures

<b>SEB 6448</b>				<b>Ni</b>	<b>Au</b>
 <b>SW</b>	<b>Schwarz</b>	<b>Black</b>		99014162	99016730
 <b>RT</b>	<b>Rot</b>	<b>Red</b>		99018828	99020400
 <b>BL</b>	<b>Blau</b>	<b>Blue</b>		99021755	99017849
 <b>GE</b>	<b>Gelb</b>	<b>Yellow</b>		99021506	99017851
 <b>GN</b>	<b>Grün</b>	<b>Green</b>		99021757	99017788
 <b>GR</b>	<b>Grau</b>	<b>Grey</b>		99021752	99012496
 <b>BR</b>	<b>Braun</b>	<b>Brown</b>		99017890	99017850
 <b>WS</b>	<b>Weiß</b>	<b>White</b>		99019372	99017852
 <b>VI</b>	<b>Violett</b>	<b>Purple</b>		99021761	99012498
 <b>OR</b>	<b>Orange</b>	<b>Orange</b>		99021759	99020622
 <b>GNGE</b>	<b>Grüngelb</b>	<b>green-yellow</b>		99016732	99016733