



SEB 6450

Safety threaded socket

Ø 4mm Safety

1000 V CAT III

24 A

- for fixture in panels up to 6 mm thick
- fixed by: slotted nut M12 x 0.75 and spring washer
- hole Ø 12.2+0.1 mm
- flat tab can be bent up to 90° once
- turned part
- fixture using special tools MWZ 8 and MWZ 15, see chapter accessories
- fastening nut (slotted nut) M12 x 0.75

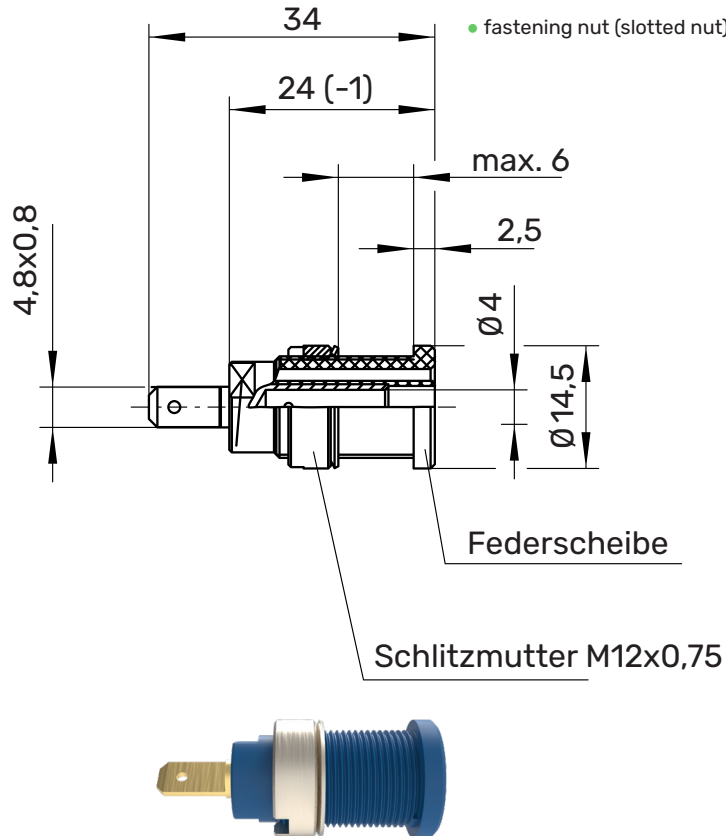

! WH 034



MA 007



General information

Order No. ¹⁾	SEB 6450 Ni Au / ..(colour)
colours	black, red, blue, yellow, green, grey, brown, white, orange, purple, green-yellow
contact parts	nickel-plated gold-plated
insulation	PA 6.6 (Polyamid) UL94 - V2

Technical data











terminal	FSH 4,8 mm x 0,8 mm
transition resistance	5 mΩ (Ni) 3 mΩ (Au)
rated voltage ²⁾	1000 V CAT III
rated voltage ²⁾	24 A
operating temperature	from -25 °C to +80 °C
max. torque	45 Ncm
fastening nut	

¹⁾ other contact platings, colours and terminals on request
²⁾ at normal ambient temperatures

SEB 6450

Ni

Au

 SW	Schwarz	Black	99014163	99016772
 RT	Rot	Red	99016606	99018993
 BL	Blau	Blue	99017182	99012878
 GE	Gelb	Yellow	99017419	99012879
 GN	Grün	Green	99018353	99017396
 GR	Grau	Grey	99016601	99012881
 BR	Braun	Brown	99016602	99017397
 WS	Weiß	White	99017259	99017470
 VI	Violett	Purple	99022121	
 OR	Orange	Orange	99017957	99017941
 GNGE	Grüngelb	green-yellow	99016771	99016773