



SEB 6452

Sicherheits-Einbaubuchse

Ø 4mm Sicherheit

1000 V CAT III

32 A

- zum Einbauen in Frontplatten bis 6 mm Dicke
- Befestigung mittels einer Schlitzmutter M12 x 0,75 und einer Federscheibe
- Montagebohrung Ø 12,2+0,1 mm
- Flachsteckzunge einmalig bis 90° abbiegbar
- Drehteil
- Montage mittels Montagewerkzeug MWZ 8 und MWZ 15
- Befestigungsmutter (Schlitzmutter) M12 x 0,75

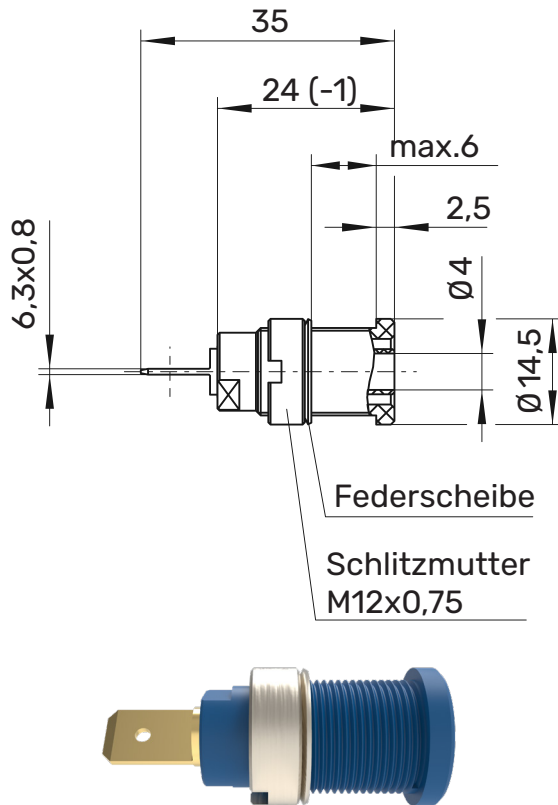

! WH 005



MA 007



Allgemeine Angaben

| | |
|-------------------------|--|
| Best.-Nr. ¹⁾ | SEB 6452 Ni Au / ..(Farbe) |
| Farben | schwarz, rot, blau, gelb, grün, grau, braun, weiß, orange, violett, grüngelb |
| Kontaktteile | vernickelt vergoldet |
| Isolierteil | PA 6.6 (Polyamid) UL94 - V2 |











Technische Daten

| | |
|----------------------------------|-----------------------|
| Anschluss | FSH 4,8 mm x 0,8 mm |
| Durchgangswiderstand | 5 mΩ (Ni) 3 mΩ (Au) |
| Bemessungsspannung ²⁾ | 1000 V CAT III |
| Bemessungsstrom ²⁾ | 32 A |
| Betriebstemperatur | von -25 °C bis +80 °C |
| Anzugsdrehmoment | 45 Ncm |

der Befestigungsmutter

SCHÜTZINGER

¹⁾ andere Kontaktoberflächen, Farben und Anschlüsse auf Anfrage
²⁾ bei normalen Umgebungstemperaturen

| SEB 6452 | | | | Ni | Au |
|---|-------------|-----------------|---------------------|-----------|-----------|
|  | SW | Schwarz | Black | 99014164 | 99016761 |
|  | RT | Rot | Red | 99015872 | 99012990 |
|  | BL | Blau | Blue | 99016283 | 99017092 |
|  | GE | Gelb | Yellow | 99017023 | 99012992 |
|  | GN | Grün | Green | 99018210 | 99017966 |
|  | GR | Grau | Grey | 99016974 | 99018372 |
|  | BR | Braun | Brown | 99016972 | 99017090 |
|  | WS | Weiß | White | 99016664 | 99012996 |
|  | VI | Violett | Purple | 99012988 | 99018373 |
|  | OR | Orange | Orange | 99018042 | 99021776 |
|  | GNGE | Grüngelb | green-yellow | 99015510 | 99016775 |