



SEB 6452

Safety threaded socket

Ø 4mm Safety

1000 V CAT III

32 A

- for fixture in panels up to 6 mm thick
- fixed by: slotted nut M12 x 0.75 and spring washer
- hole Ø 12.2+0.1 mm
- flat tab can be bent up to 90° once
- turned part
- fixture using special tools MWZ 8 and MWZ 15
- fastening nut (slotted nut) M12 x 0.75

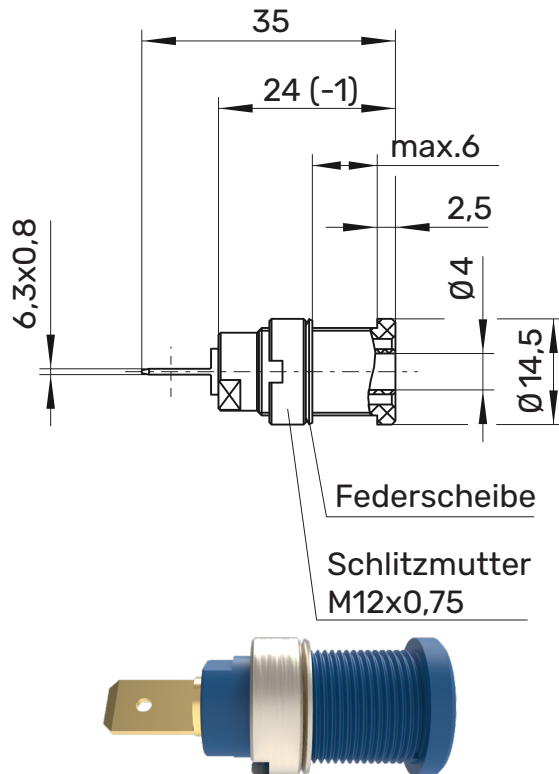

! WH 005



MA 007



General information

Order No. ¹⁾	SEB 6452 Ni Au / ..(colour)
contact parts	black, red, blue, yellow, green, grey, brown, white, orange, purple, green-yellow
contact parts	nickel-plated gold-plated
insulation	PA 6.6 (Polyamid) UL94 - V2

Technical data











terminal	FSH 4,8 mm x 0,8 mm
transition resistance	5 mΩ (Ni) 3 mΩ (Au)
rated voltage ²⁾	1000 V CAT III
rated current ²⁾	32 A
operating temperature	from -25 °C to +80 °C
max. torque	45 Ncm
fastening nut	SCHÜTZINGER

¹⁾ other contact platings, colours and terminals on request
²⁾ at normal ambient temperatures

SEB 6452

Ni

Au

	SW	Schwarz	Black	99014164	99016761
	RT	Rot	Red	99015872	99012990
	BL	Blau	Blue	99016283	99017092
	GE	Gelb	Yellow	99017023	99012992
	GN	Grün	Green	99018210	99017966
	GR	Grau	Grey	99016974	99018372
	BR	Braun	Brown	99016972	99017090
	WS	Weiß	White	99016664	99012996
	VI	Violett	Purple	99012988	99018373
	OR	Orange	Orange	99018042	99021776
	GNGE	Grüngelb	green-yellow	99015510	99016775