



SEB 9424

Sicherheits-Einbaubuchse

Ø 4mm Sicherheit

1500 V_{DC}

1000 V CAT III

600 V CAT IV

32 A

- zum Einbauen in Frontplatten bis 3 mm Dicke
- Befestigung mittels einer Sechskantmutter M12 x 0,75 und einer Federscheibe
- Montagebohrung Ø 12,2+0,1 mm
- Befestigungsmutter (Sechskantmutter) M12 x 0,75

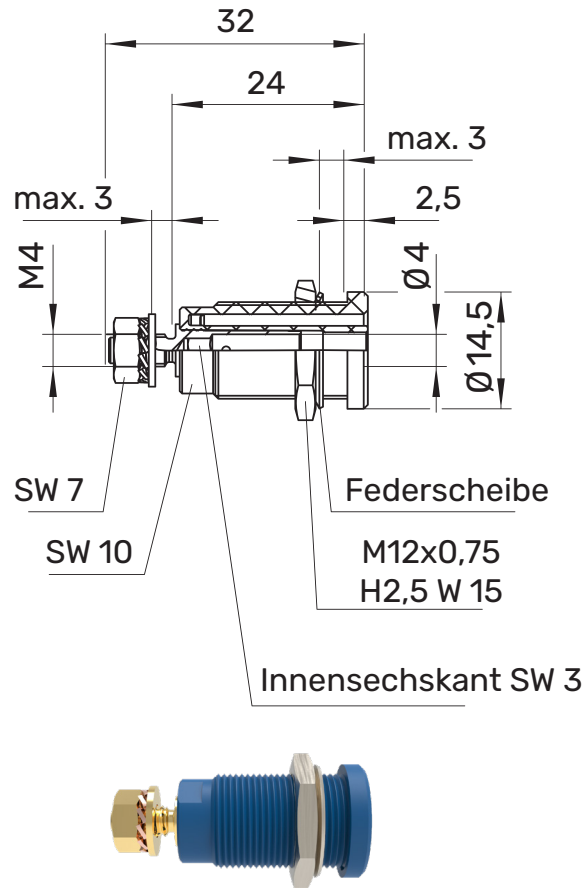

! WH 062



MA 028



Allgemeine Angaben

Best.-Nr. ¹⁾	SEB 9424 Ni Au ... (Farbe)
Farben	schwarz, rot, blau, gelb, grün, grau, braun, weiß, orange, violett, grüngelb
Kontaktteile	vernickelt vergoldet
Isolierteil	PA 6.6 (UL94-V2)

Technische Daten











Anschluss	M4 x 0,7 Mutter
Durchgangswiderstand ⁴⁾	7 mΩ (Ni) / 5 mΩ (Au)
Bemessungsspannung ²⁾	1500V _{DC} / 1000V CAT III / 600V CAT IV
Bemessungsstrom ²⁾	32 A
Betriebstemperatur	von -25 °C bis +80 °C
Anzugsdrehmoment der Befestigungsmutter	45 Ncm
Anzugsdrehmoment der Mutter M4	100 Ncm

¹⁾ andere Kontaktflächen, Farben und Anschlüsse auf Anfrage
²⁾ bei normalen Umgebungstemperaturen
⁴⁾ abhängig von der Kontaktfläche

SEB 9424

Ni

Au

	SW	Schwarz	Black	99022744	99022750
	RT	Rot	Red	99022745	99022751
	BL	Blau	Blue	99022746	99022752
	GE	Gelb	Yellow	99022747	99022753
	GN	Grün	Green	99022748	99022754
	GR	Grau	Grey		
	BR	Braun	Brown		
	WS	Weiß	White		
	VI	Violett	Purple		
	OR	Orange	Orange		
	GNGE	Grüngelb	green-yellow	99022749	99022755