



SEB 9424

Safety threaded socket

Ø 4mm Safety

1500 V_{DC}

1000 V CAT III

600 V CAT IV

32 A

- for fixture into panels up to 3 mm thick
- fixed by: hexagon nut M12 x 0.75 and spring washer
- hole Ø 12,2+0.1 mm
- fastening nut (hexagon nut) M12 x 0,75

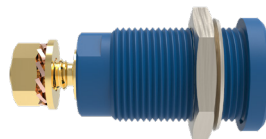
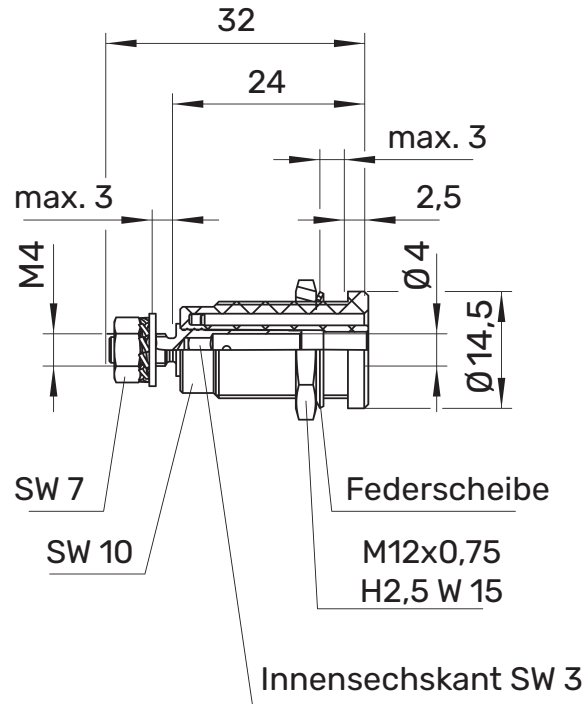

! WH 062



MA 028



General information

Order No. ¹⁾	SEB 9424 Ni Au ... (colour)
colours	black, red, blue, yellow, green, grey, brown, white, orange, purple, green-yellow
contact parts	nickel-plated gold-plated
insulation	PA 6.6 (UL94-V2)

Technical data











terminal	M4 x 0,7 hexagon nut
transition resistance ⁴⁾	7 mΩ (Ni) / 5 mΩ (Au)
rated voltage ²⁾	1500V _{DC} / 1000V CAT III / 600V CAT IV
rated current ²⁾	32 A
operating temperature	from -25 °C to +80 °C
max. torque	45 Ncm
fastening nut	
max. torque	100 Ncm
nut M4	

¹⁾ other contact platings, co-colours and terminals on request
²⁾ at normal ambient temperatures
⁴⁾ depending on contact plating

SEB 9424

Ni

Au

	SW	Schwarz	Black	99022744	99022750
	RT	Rot	Red	99022745	99022751
	BL	Blau	Blue	99022746	99022752
	GE	Gelb	Yellow	99022747	99022753
	GN	Grün	Green	99022748	99022754
	GR	Grau	Grey		
	BR	Braun	Brown		
	WS	Weiß	White		
	VI	Violett	Purple		
	OR	Orange	Orange		
	GNGE	Grüngelb	green-yellow	99022749	99022755