



SEPB 7089

Safety press-in socket

Ø 4mm safety

1000 V CAT III

24 A

- for pressing into panels up to 6 mm thick
- location hole Ø 12.2±0.1 mm, countersunk one-sided (approx. 0.5 x 45°)
- panel thickness:
metal panels: ≥ 1 mm
plastic panels: ≥ 2 mm
- flat tab can be bent up to 90° once
- punched part
- fixture using special tool MWZ 13

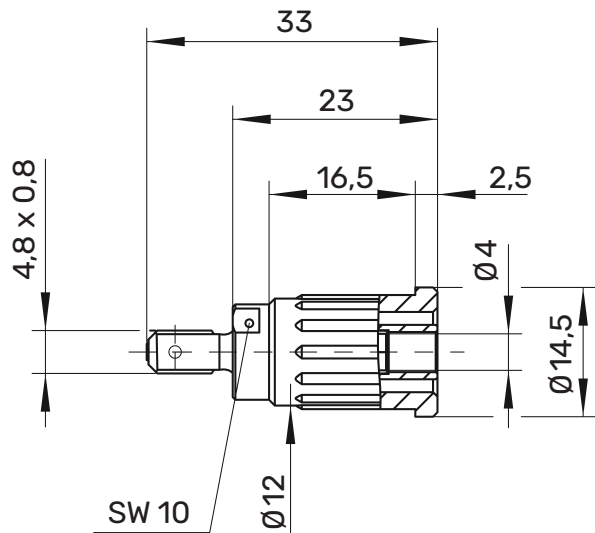

MA 005



General information

Order No. ¹⁾	SEPB 7089 Ni ...(colour)
colours	black, red, blue, yellow, green, grey, brown, white, orange, purple, green-yellow
contact parts	nickel-plated
insulation	PA 6.6 (Polyamid) UL94 - V2











Technical data

terminal	FR 4.8 mm x 0.8 mm
transition resistance	5 mΩ (Ni)
rated voltage ²⁾	1000 V CAT III
rated current ²⁾	24 A
operating temperature	from -25 °C to +80 °C

¹⁾ other contact platings, colours and terminals on request
²⁾ at normal ambient temperatures

SEPB 7089

Ni

 SW	Schwarz	Black	99014154
 RT	Rot	Red	99015968
 BL	Blau	Blue	99015969
 GE	Gelb	Yellow	99015970
 GN	Grün	Green	99015971
 GR	Grau	Grey	
 BR	Braun	Brown	
 WS	Weiß	White	
 VI	Violett	Purple	
 OR	Orange	Orange	
 GNGR	Grüngelb	green-yellow	99016179