



SEPB 7090

Safety press-in socket

Ø 4mm safety

1000 V CAT III

24 A

- for pressing into panels up to 6 mm thick
- location hole Ø 12.2±0.1 mm, countersunk one-sided (approx. 0.5 x 45°)
- panel thickness:
metal panels: ≥ 1 mm
plastic panels: ≥ 2 mm
- flat tab, can be bent up to 90° once
- punched part
- fixture using special tool MWZ 13

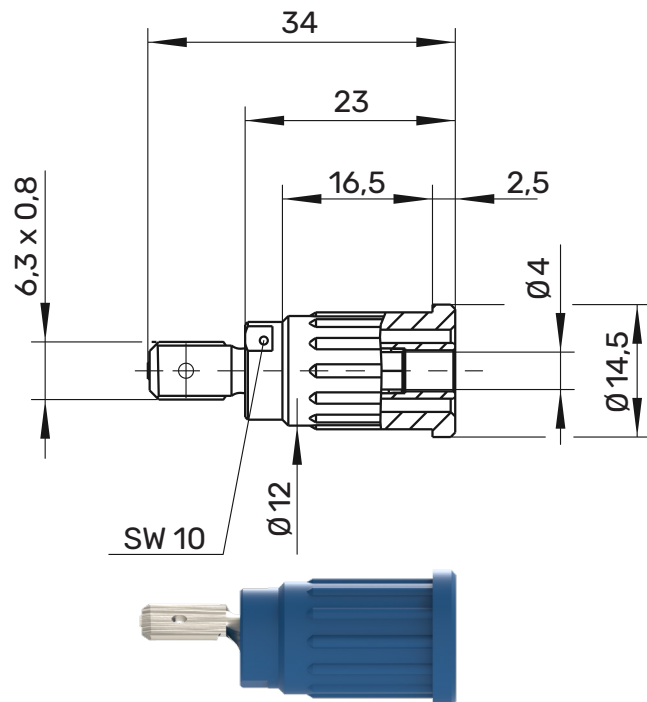

! WH 034



MA 005



General information

Order No. ¹⁾	SEPB 7090 Ni ...(colour)
colours	black, red, blue, yellow, green, grey, brown, white, orange, purple, green-yellow
contact parts	nickel-plated
insulation	PA 6.6 (Polyamid) UL94 - V2









Technical data

terminal	FSH 6,3 mm x 0,8 mm
transition resistance	5 mΩ (Ni)
rated voltage ²⁾	1000 V CAT III
rated current ²⁾	24 A
operating temperature	from -25 °C to +80 °C

¹⁾ other contact platings, colours and terminals on request
²⁾ at normal ambient temperatures

SEPB 7090

Ni

	SW	Schwarz	Black	99014156
	RT	Rot	Red	99015972
	BL	Blau	Blue	99015973
	GE	Gelb	Yellow	99015974
	GN	Grün	Green	99015975
	GR	Grau	Grey	
	BR	Braun	Brown	99020662
	WS	Weiß	White	
	OR	Orange	Orange	
	PVI	Violett	Purple	
	GNGR	Grüngelb	Green-yellow	99016182