



## POL 102 Terminal post

Ø 4mm

1000 V

100 A

- with captive toggle head
- max. conducting wall thickness 4 mm

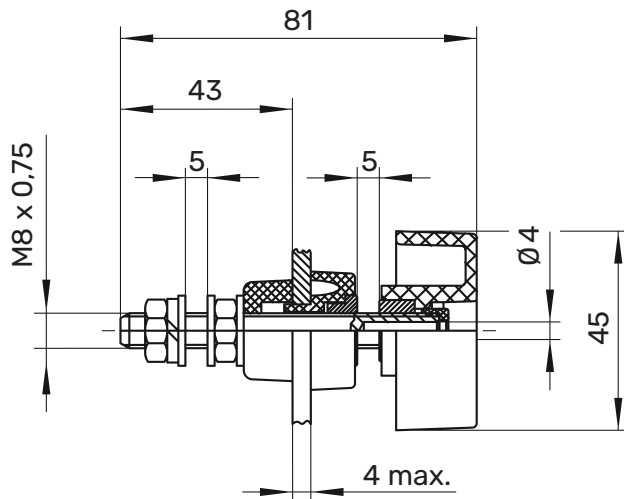

Montagebohrung / hole:

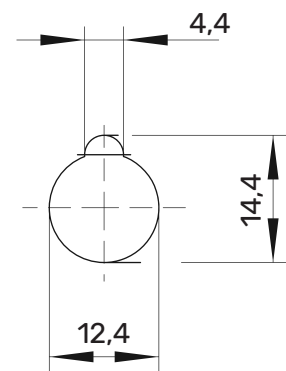

### General information

Order No. <sup>1)</sup>	<b>POL 102 / ... (colour)</b>
colours	black, red, blue, yellow, green, green-yellow
contact parts	brass
insulation	polycarbonate







### Technical data

terminal	M8 x 0.75, solder lug, cable lug, inlinesocket
transition resistance	0,4 mΩ
rated voltage <sup>2)</sup>	1000 V
rated current <sup>2)</sup>	100 A
operating temperature	from -25 °C to +115 °C
max. torque	600 Ncm
fastening nut	

<sup>1)</sup> other designs on request  
<sup>2)</sup> at normal ambient temperatures

**POL 102**

Ms

 <b>SW</b>	<b>Schwarz</b>	<b>Black</b>	99003999
 <b>RT</b>	<b>Rot</b>	<b>Red</b>	99003998
 <b>BL</b>	<b>Blau</b>	<b>Blue</b>	99003994
 <b>GE</b>	<b>Gelb</b>	<b>Yellow</b>	99003995
 <b>GN</b>	<b>Grün</b>	<b>Green</b>	99003996
 <b>GNGE</b>	<b>Grüngelb</b>	<b>Green-yellow</b>	99003997