



## POL 631

### Polklemme

Ø 4mm

1000 V

63 A

- mit unverlierbarem Knebelkopf
- max. leitende Gehäusewandstärke 3 mm

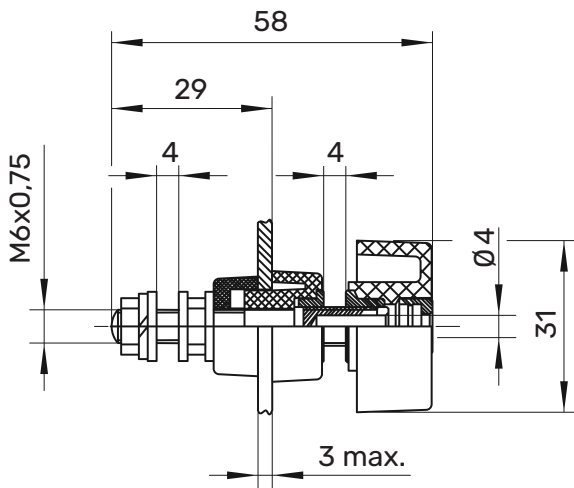

Montagebohrung / hole:

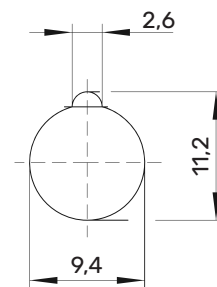

### Allgemeine Angaben

Best.-Nr. <sup>1)</sup>	<b>POL 631 / ..(Farbe)</b>
Farben	schwarz, rot, blau, gelb, grün, grüngelb
Kontaktteile	Messing
Isolierteil	Polycarbonat







### Technische Daten

Anschluss	M6 x 0,75, Lötöse, Kabelschuh, Steckbuchse
Durchgangswiderstand	0,4 mΩ
Bemessungsspannung <sup>2)</sup>	1000 V
Bemessungsstrom <sup>2)</sup>	63 A
Betriebstemperatur	von -25 °C bis +115 °C
Anzugsdrehmoment	300 Ncm
der Befestigungsmutter	

<sup>1)</sup> andere Ausführungen auf Anfrage  
<sup>2)</sup> bei normalen Umgebungstemperaturen

**POL 631**

Ms

 <b>SW</b>	<b>Schwarz</b>	<b>Black</b>	99004030
 <b>RT</b>	<b>Rot</b>	<b>Red</b>	99004029
 <b>BL</b>	<b>Blau</b>	<b>Blue</b>	99004025
 <b>GE</b>	<b>Gelb</b>	<b>Yellow</b>	99004026
 <b>GN</b>	<b>Grün</b>	<b>Green</b>	99004027
 <b>GNGE</b>	<b>Grüngelb</b>	<b>Green-yellow</b>	99004028