



SDK 504

Schnelldruckklemme

Ø 4mm

30 V_{AC} / 60 V_{DC}

16 A

- nicht isolierter Einbau für nichtmetallische Frontplatten

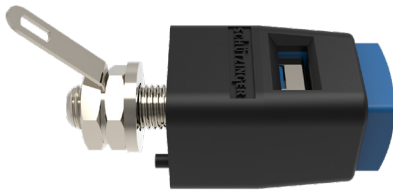
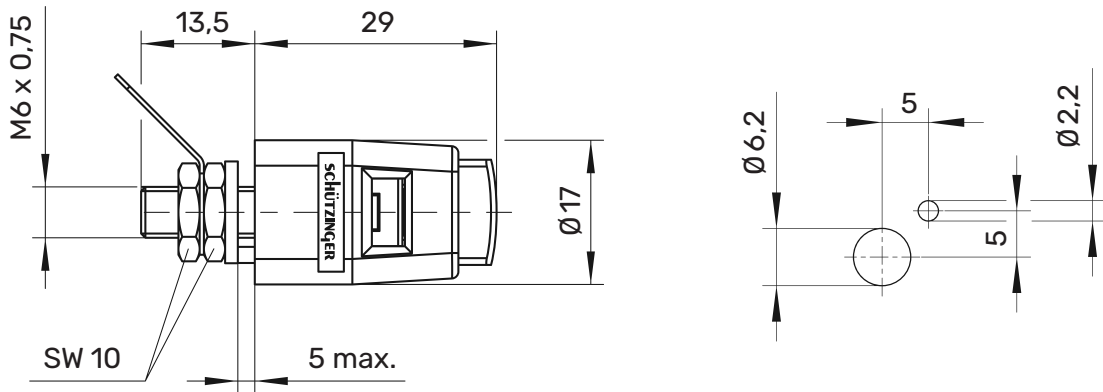

Allgemeine Angaben

Best.-Nr. ¹⁾	SDK 504 Ni / ...(Farbe)
Farben	schwarz, rot, blau, gelb, grün, grau, braun, weiß, orange, violett,grüngelb
Kontaktteil	vernickelt
Isolierteil	PA 6.6 (Polyamid)

Technische Daten











Anschluss	Lötöse oder Kabelschuh
Durchgangswiderstand	5 mΩ
Bemessungsspannung ²⁾	30 V _{AC} / 60 V _{DC}
Bemessungsstrom ²⁾	16 A
Betriebstemperatur	von -25 °C bis +90 °C
Frontplattenstärke	0,8 mm-5 mm
vorderes Einsteckfenster	6,5 mm x 4 mm
hinteres Einsteckfenster	8 mm x 4 mm
Druckfederkraft	20 N
Anzugsdrehmoment der Befestigungsmutter	120 Ncm

¹⁾ andere Farben, Anschlüsse und Federn (ca. 15 N oder 33 N) auf Anfrage

²⁾ bei normalen Umgebungstemperaturen

SDK 504

Ni

	SW	Schwarz	Black	99004196
	RT	Rot	Red	99004194
	BL	Blau	Blue	99004185
	GE	Gelb	Yellow	99004187
	GN	Grün	Green	99004190
	GR	Grau	Grey	99016209
	BR	Braun	Brown	99008919
	WS	Weiß	White	99008921
	VI	Violett	Purple	99016211
	OR	Orange	Orange	99016210
	GNGE	Grünelb	Green-yellow	99004192