



SDK 504

Quick-release terminal

Ø 4mm

30 V_{AC} / 60 V_{DC}

16 A

- fitting not insulated for non-metal panels

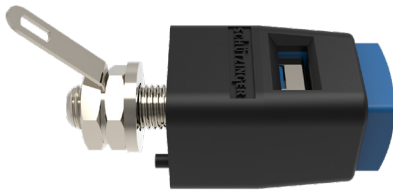
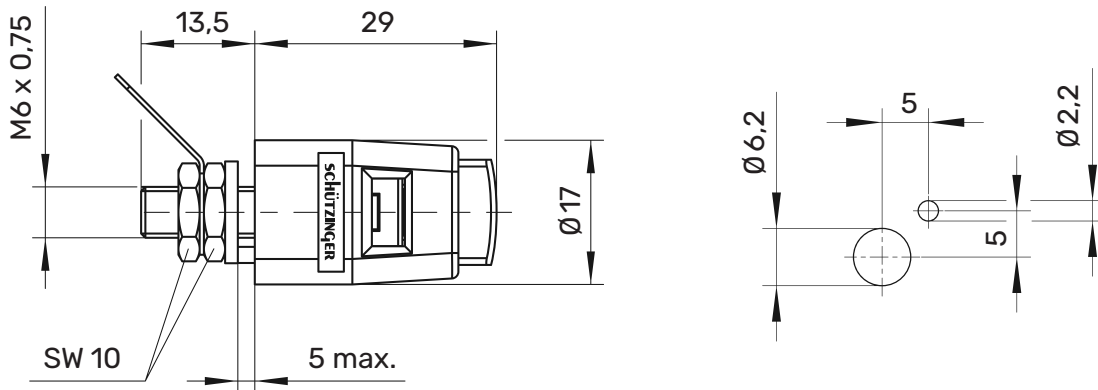

General information

| | |
|-------------------------|---|
| Order No. ¹⁾ | SDK 504 Ni / ... (colour) |
| colours | black, red, blue, yellow, green, grey, brown, white, orange, purple, green-yellow |
| contact parts | nickel-plated |
| insulation | PA 6.6 (Polyamid) |











Technical data

| | |
|-----------------------------|---|
| terminal | solder or cable lug |
| transition resistance | 5 mΩ |
| rated voltage ²⁾ | 30 V _{AC} / 60 V _{DC} |
| rated current ²⁾ | 16 A |
| operating temperature | von -25 °C bis +90 °C |
| panel thickness | 0,8 mm-5 mm |
| front insertion window | 6,5 mm x 4 mm |
| rear insertion window | 8 mm x 4 mm |
| Druckfederkraft | 20 N |
| max. torque | 120 Ncm |
| fastening nut | |

¹⁾ other colours, terminals and springs (approx. 15 N or 33 N) on request
²⁾ at normal ambient temperatures

SDK 504

Ni

| | | | | |
|---|-------------|----------------|---------------------|----------|
|  | SW | Schwarz | Black | 99004196 |
|  | RT | Rot | Red | 99004194 |
|  | BL | Blau | Blue | 99004185 |
|  | GE | Gelb | Yellow | 99004187 |
|  | GN | Grün | Green | 99004190 |
|  | GR | Grau | Grey | 99016209 |
|  | BR | Braun | Brown | 99008919 |
|  | WS | Weiß | White | 99008921 |
|  | VI | Violett | Purple | 99016211 |
|  | OR | Orange | Orange | 99016210 |
|  | GNGE | Grünelb | Green-yellow | 99004192 |