



SDK 799

Safety quick-release terminal

Ø 4mm safety

300 V CAT II

16 A

- to plug in a safety socket Ø 4 mm

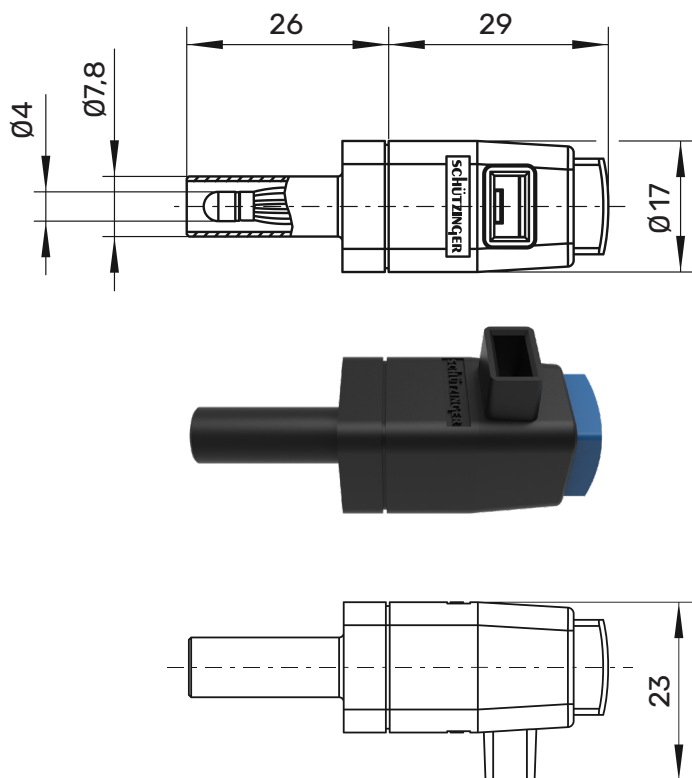

General information

Order No. ¹⁾	SDK 799 Ni / ...(colour)
colours	black, red, blue, yellow, green, grey, brown, white, orange, purple, green-yellow
contact parts	vernickelt
insulation	PA 6.6 (Polyamid)











Technical data

terminal	plug
transition resistance	5 mΩ
rated voltage ²⁾	300 V CAT II
rated current ²⁾	16 A
operating temperature	from -25 °C to +90 °C
insertion window	8 mm x 4 mm
spring force	20 N

¹⁾ other colours, terminals and springs (approx. 15 N or 33 N) on request
²⁾ at normal ambient temperatures

SDK 799

Ni

	SW	Schwarz	Black	99004206
	RT	Rot	Red	99004205
	BL	Blau	Blue	99004199
	GE	Gelb	Yellow	99004202
	GN	Grün	Green	99004203
	GR	Grau	Grey	99016228
	BR	Braun	Brown	99004200
	WS	Weiß	White	99004210
	VI	Violett	Purple	99016230
	OR	Orange	Orange	99016229
	GNGE	Grüngelb	Green-yellow	99004204