



SDK 800

Sicherheits-Schnelldruckklemme

Ø 4mm Sicherheit

300 V CAT II

16 A

- vollisolierter Einbau für metallische Frontplatten

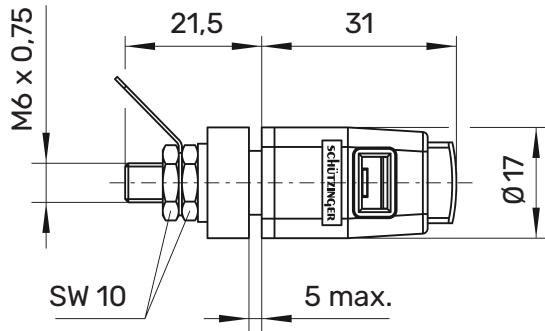

Montagebohrung

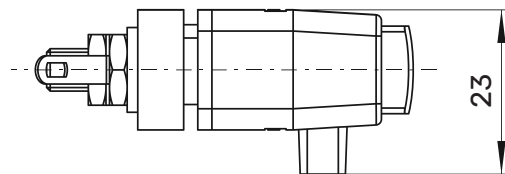
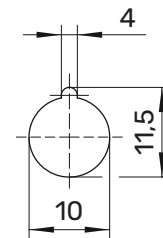

Allgemeine Angaben

Best.-Nr. ¹⁾	SDK 800 Ni / ...(Farbe)
Farben	schwarz, rot, blau, gelb, grün, grau, braun, weiß, orange, violett,grüngelb
Kontaktteil	vernickelt
Isolierteil	PA 6.6 (Polyamid)











Technische Daten

Anschluss	Lötöse oder Kabelschuh
Durchgangswiderstand	5 mΩ
Bemessungsspannung ²⁾	300 V CAT II
Bemessungsstrom ²⁾	16 A
Betriebstemperatur	von -25 °C bis +90 °C
Frontplattenstärke	0,8 mm-5 mm
Einsteckfenster	8 mm x 4 mm
Druckfederkraft	20 N
Anzugsdrehmoment der Befestigungsmutter	120 Ncm

¹⁾ andere Farben, Ausführungen des Anschlusses und Federn (ca. 15 N oder 33 N) auf Anfrage
²⁾ bei normalen Umgebungstemperaturen

SDK 800

Ni

	SW	Schwarz	Black	99004223
	RT	Rot	Red	99004221
	BL	Blau	Blue	99004214
	GE	Gelb	Yellow	99004216
	GN	Grün	Green	99004218
	GR	Grau	Grey	99016225
	BR	Braun	Brown	99009301
	WS	Weiß	White	99011088
	VI	Violett	Purple	99016227
	OR	Orange	Orange	99016226
	GNGE	Grünelb	Green-yellow	99004219