



SDK 801

Safety quick-release terminal

Ø 4mm Sicherheit

300 V CAT II

16 A

- fitting not insulated for non-metal panels

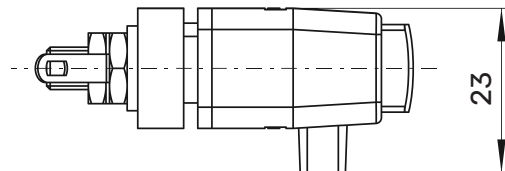
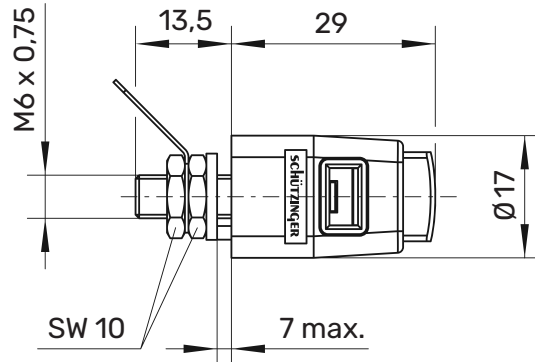

Montagebohrung/hole

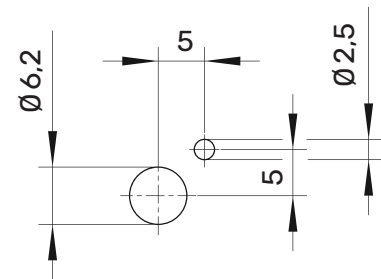

General information

Order No. ¹⁾	SDK 801 Ni / ... (colour)
colours	black, red, blue, yellow, green, grey, brown, white, orange, purple, green-yellow
contact parts	nickel-plated
insulation	PA 6.6 (Polyamid)

Technical data











terminal	solder or cable lug
transition resistance	5 mΩ
rated voltage ²⁾	300 V CAT II
rated current ²⁾	16 A
operating temperature	from -25 °C to +90 °C
panel thickness	0,8 mm-5 mm
insertion window	8 mm x 4 mm
spring force	20 N
max. torque	120 Ncm
fastening nut	

¹⁾ other colours, terminals and springs (approx. 15 N or 33 N) on request

²⁾ at normal ambient temperatures

SDK 801

Ni

	SW	Schwarz	Black	99004237
	RT	Rot	Red	99004235
	BL	Blau	Blue	99004227
	GE	Gelb	Yellow	99004230
	GN	Grün	Green	99004232
	GR	Grau	Grey	99016219
	BR	Braun	Brown	99008970
	WS	Weiß	White	99008972
	VI	Violett	Purple	99016221
	OR	Orange	Orange	99016220
	GNGE	Grüngelb	Green-yellow	99004233