



ESD 798

Sicherheits-Schnelldruckklemme

Ø 4mm Sicherheit

300 V CAT II

16 A

- vollisolierter Einbau für metallische Frontplatten

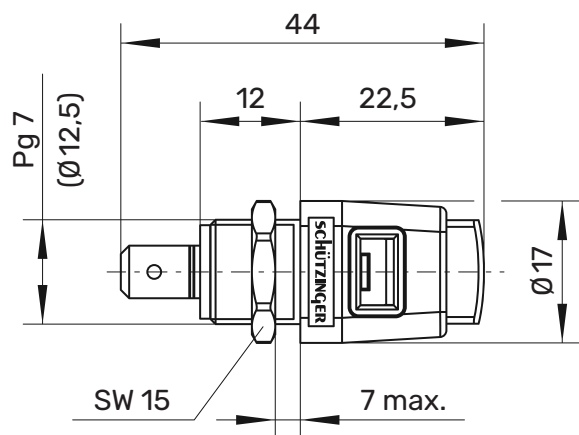

Montagebohrung

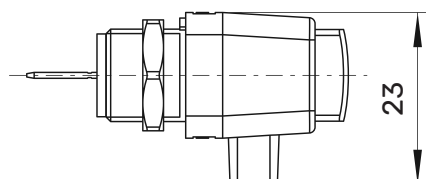
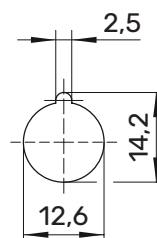

Allgemeine Angaben

Best.-Nr. ¹⁾	ESD 798 / ..(Farbe)
Farben	schwarz, rot, blau, gelb, grün, grau, braun, weiß, orange, violett, grüngelb
Kontaktteil	vernickelt
Isolierteil	PA6.6 (Polyamid)

Technische Daten











Anschluss	FSH 6,3 mm x 0,8 mm oder Lötten
Durchgangswiderstand	5 mΩ
Bemessungsspannung ²⁾	300 V CAT II
Bemessungsstrom ²⁾	16 A
Betriebstemperatur	von -25 °C bis +90 °C
Frontplattenstärke	0,8 mm-7 mm
Einsteckfenster	8 mm x 4 mm
Flachsteckzunge	6,3 mm x 0,8 mm
Druckfederkraft	20 N

¹⁾ andere Farben, Ausführungen des Anschlusses und Federn (ca. 15 N oder 33 N) auf Anfrage

²⁾ bei normalen Umgebungstemperaturen

ESD 798

Ni

	SW	Schwarz	Black	99000664
	RT	Rot	Red	99000662
	BL	Blau	Blue	99000657
	GE	Gelb	Yellow	99000659
	GN	Grün	Green	99000661
	GR	Grau	Grey	99015201
	BR	Braun	Brown	99008592
	WS	Weiß	White	99008885
	VI	Violett	Purple	99016215
	OR	Orange	Orange	99016214
	GNGE	Grüngelb	Green-yellow	99007987