



stairparts

Stair Parts:	Pages
Alder	2-7
Hemlock.....	8
Knotty Pine	9-10
Maple.....	11-19
Oak.....	20-30
Poplar	31-39
Primed	40-41
White Oak.....	42-44
Hardware.....	46-47

Oak & Poplar handrail stocked as solid cap.

Solid cap rail specifications:

- Lengths under 14' do not contain finger-joints in the top ply
- 14' & 16' will have one finger-joint in the top ply
- 8', 10', 12' Solid Cap
- 14' & 16' - 1 Joint

Alder, Knotty Pine & Maple handrail stocked as solid cap.

Solid cap rail specifications:

- 8' and 10' - Solid Cap (note: optional 1 joint in occasional 10')
- 12' and 14' - Possible 1 Joint
- 16' - Up to 2 Joints



The “clear” grade lumber used in the manufacture of our stock Alder stair parts is inclusive of Cabinet and Superior grades. This “clear” grade allow for sound knots up to dime size with some voids. Request for completely clear alder parts will be quoted on a special order basis, and should be specified as exclusively Superior grade alder. Handrail specified as exclusively Superior will have additional finger-joints to achieve lengths.

Alder Rail



6010 Rail 2-1/4" x 2-3/8"	6010P Rail 2-1/4" x 2-3/8" 1-1/4" Plow Includes 6107 fillet	6210 Rail 2-5/8" x 2-3/8"	6210P1 Rail 2-5/8" x 2-3/8" 1-3/4" Plow Includes 6007 fillet	6400 Rail 2-1/4" x 2-7/16"
-------------------------------------	---	-------------------------------------	--	--------------------------------------

6' pc	\$151.59	\$186.08	\$179.95	\$213.68	\$89.06
8' pc	\$202.12	\$248.11	\$239.93	\$284.91	\$118.75
10' pc	\$252.65	\$310.14	\$299.92	\$356.13	\$148.44
12' pc	\$303.18	\$372.17	\$359.90	\$427.36	\$178.12
14' pc	\$353.70	\$434.19	\$419.88	\$498.58	\$207.81
16' pc	\$404.23	\$496.22	\$479.87	\$569.81	\$237.53

Alder Rail

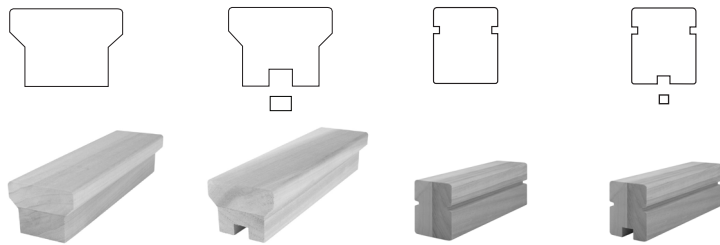

6500 Rail 2-1/4" x 1-5/8"	6500P2 Rail 2-1/4" x 1-5/8" 1/2" Plow Includes 6207 fillet	6570* Rail 1-11/16" x 2"	6570P2* Rail 1-11/16" x 2" 1/2" Plow Includes 6207 fillet
-------------------------------------	--	------------------------------------	---

6' pc	\$59.28	\$66.92	\$75.93	\$84.32
8' pc	\$79.06	\$81.13	\$101.25	\$112.42
10' pc	\$98.81	\$111.56	\$126.56	\$140.54
12' pc	\$118.56	\$133.84	\$151.86	\$168.65
14' pc	\$138.35	\$141.99	\$177.20	\$196.76
16' pc	\$158.13	\$162.26	\$202.50	\$224.85
18' pc	\$276.38	---	---	---

**Handrails may not meet graspability codes. Please check local building codes before installing.*

Alder Rail

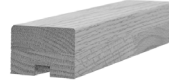
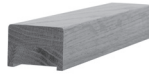
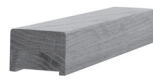
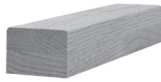

**6770*
Rail**

2-1/4" x 1-9/16"

**6770P*
Rail**

2-1/4" x 1-9/16"
1-1/4" Plow
Includes 6107
fillet

**6770P1*
Rail**

2-1/4" x 1-9/16"
1-3/4" Plow
Includes 6007
fillet

**6770P2*
Rail**

2-1/4" x 1-9/16"
1/2" Plow
Includes 6207
fillet

6' pc	\$77.81	\$79.72	\$152.35	\$114.80
8' pc	\$103.74	\$106.30	\$203.14	\$100.85
10' pc	\$129.68	\$132.87	\$253.92	\$126.06
12' pc	\$155.61	\$159.44	\$304.71	\$229.60
14' pc	\$181.55	\$186.02	\$355.49	\$267.86
16' pc	\$207.48	\$212.59	\$406.28	\$306.13
18' pc	\$233.42	---	---	---



The “clear” grade lumber used in the manufacture of our stock Alder stair parts is inclusive of Cabinet and Superior grades. This “clear” grade allow for sound knots up to dime size with some voids. Request for completely clear alder parts will be quoted on a special order basis, and should be specified as exclusively Superior grade alder. Handrail specified as exclusively Superior will have additional finger-joints to achieve lengths.

Alder Shoe Rail

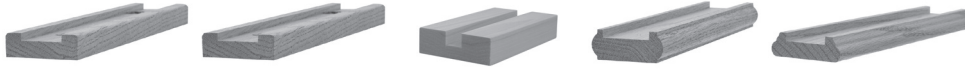

6001 Shoe Rail	6002 Shoe Rail	6003 Shoe Rail	6006 Shoe Rail	6045 Shoe Rail
2-1/4" x 7/8" 1-1/4" Plow Includes 6107 fillet	2-1/4" x 7/8" 1-3/4" Plow Includes 6007 fillet	2-3/8" x 3/4" 1/2" Plow Includes 6207 fillet	2-5/8" x 1" 1-3/4" Plow Includes 6007 fillet	2-1/4" x 3/4" 1-1/4" Plow Includes 6107 fillet

6' pc	\$95.63	\$100.23	\$41.20	\$106.36	\$84.71
8' pc	\$127.50	\$133.64	\$54.93	\$141.81	\$112.94
10' pc	\$159.38	\$167.05	\$68.66	\$177.27	\$141.18
12' pc	\$191.26	\$200.46	\$82.40	\$212.72	\$169.41
14' pc	\$223.13	\$233.87	\$96.13	\$248.17	\$197.65
16' pc	\$255.01	\$267.27	\$108.50	\$283.63	\$225.88

Alder Fillet



6007 Fillet	6107 Fillet	6207 Fillet
1-3/4" x 3/8"	1-1/4" x 1/4"	1/2" x 3/8"

LF	\$2.99	\$1.33	\$1.17
----	--------	--------	--------

Alder Balusters

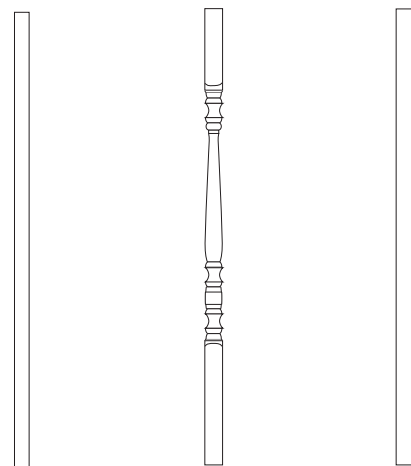

5060	5005	5360
1-1/4"	1-3/4"	1-3/4"

36"	\$20.06	\$47.53	\$40.21
42"	\$25.23	\$64.90	\$48.68

The "clear" grade lumber used in the manufacture of our stock Alder stair parts is inclusive of Cabinet and Superior grades. This "clear" grade allow for sound knots up to dime size with some voids. Request for completely clear alder parts will be quoted on a special order basis, and should be specified as exclusively Superior grade alder. Handrail specified as exclusively Superior will have additional finger-joints to achieve lengths.

Alder Box Newels				55" Height		47-1/2"		59-1/2"	
4090 Plain 3-1/2" Post 4-1/2" Base		4091 Plain 4-3/4" Post 6-1/4" Base		4097 Plain 6" Post 7-1/2" Base		4095 Plain 5" Post		4096 Plain 5" Post	
Full	\$351.32	\$489.74	\$735.66	Full	\$281.97	\$364.14			
Half	\$227.08	\$303.96	\$440.55	Half	\$188.55	\$234.20			

The 4090 series includes an adjustable base. Two caps included with the 4090 & 4091 series.

Alder Newel Parts

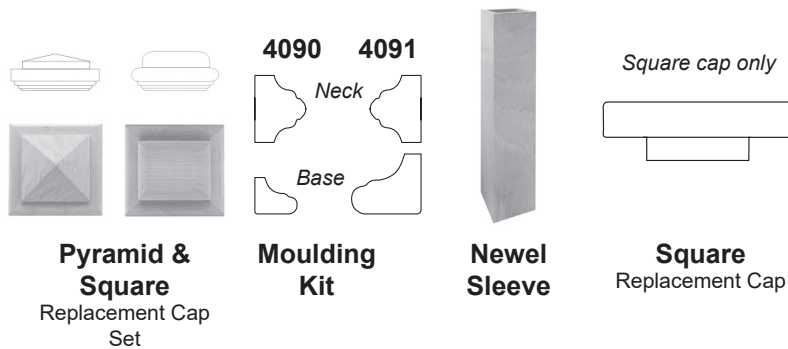

4090	\$71.58	\$32.23	\$138.65	---
4091	\$94.16	\$32.23	---	---
4095/96	---	---	---	\$54.01

Set includes collar, pyramid & square cap



	Block 30*	Block 2 TIER**
Each	\$84.48	\$34.05

*30" mounting block allows you to tie into structural framing used with 4091 & 4092 (an 8" block sent standard with all box newels).

**2 TIER mounting block allows you to tie into structural framing used with 4091 & 4093 (an 8" block sent standard with all box newels).

The "clear" grade lumber used in the manufacture of our stock Alder stair parts is inclusive of Cabinet and Superior grades. This "clear" grade allow for sound knots up to dime size with some voids. Request for completely clear alder parts will be quoted on a special order basis, and should be specified as exclusively Superior grade alder. Handrail specified as exclusively Superior will have additional finger-joints to achieve lengths.

Alder Newels

3-1/2"



4001CH
56"



4501
56"



4503
56"



4505
56"



4001DC
59-1/2"

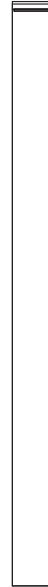

4001SG
59-1/2"

Full	\$253.00	\$317.42	\$317.42	\$317.42	\$202.44	\$202.44
Half	\$137.15	\$169.36	\$169.36	\$169.36	\$111.87	\$111.87

Alder Newels

3-1/2"



4001CG
59-1/2"

Full	\$296.26
Half	\$158.77

Alder Tread - Nosing/Cove

Lineal Feet (LF)

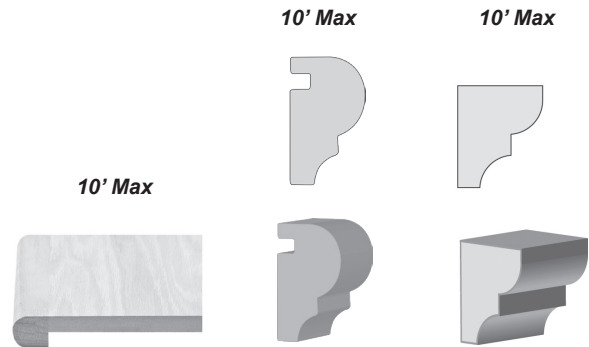

8590
Solid Landing
Tread

1-1/16" x 5-1/2"

8081
Nosing/Cove

1-1/8" x 1-13/16"

8181
Super Cove

5/8" x 3/4"

Random LF	\$9.68	\$7.86	\$1.60
Specified LF	\$12.10	\$9.82	\$2.00

The "clear" grade lumber used in the manufacture of our stock Alder stair parts is inclusive of Cabinet and Superior grades. This "clear" grade allow for sound knots up to dime size with some voids. Request for completely clear alder parts will be quoted on a special order basis, and should be specified as exclusively Superior grade alder. Handrail specified as exclusively Superior will have additional finger-joints to achieve lengths.

Alder Rosettes

Each

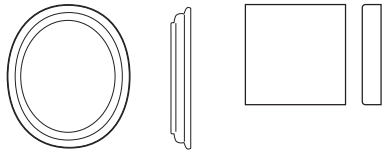

7037
Oval Rosette
3/4" x 4-1/4" x
5-3/4"

7340
Square Rosette
4" x 4"

Each	\$14.50	\$8.95
-------------	----------------	---------------

Alder Skirtboards

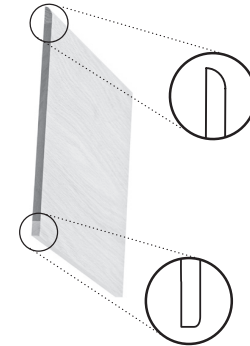

**990/Eased
Edge
Skirtboard**

7/16" x 9-1/4"
Veneered w/
finger-joint cap

8'	\$105.91
16'	\$211.82
18'	\$241.29

Alder Tread & Riser Caps

Each

8071 & 8072 Side Profile

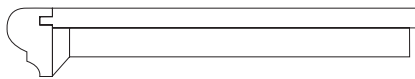

Available in Left Hand & Right Hand

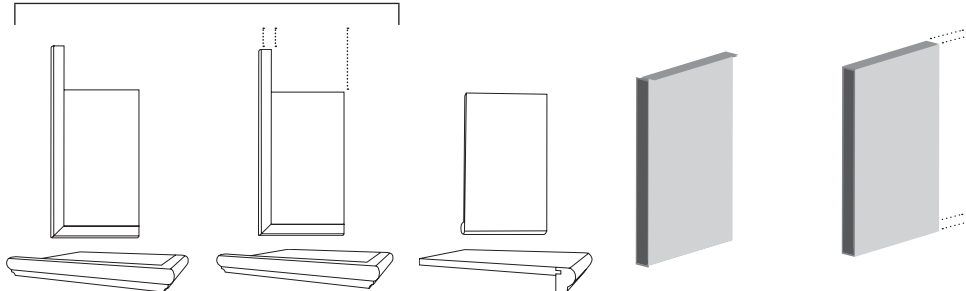

8071-06*
Tread Cap
6-1/2" x 11-1/2"
Return Tread
Cap w/ 6-1/2" x 8"
Riser Cap

8071-16
Tread Cap
16" x 11-1/2"
Return Tread Cap
w/ 16" x 8"
Riser Cap

8072-06
Tread Cap
6-1/2" x 11-1/2"
Tread Cap w/
6-1/2" x 8"
Riser Cap

8076-06
Riser Cap
6-1/2" x 8"

8076-16
Riser Cap
16" x 8"

Each	\$60.85	\$138.72	\$44.75	\$8.02	\$18.45
-------------	----------------	-----------------	----------------	---------------	----------------

*Specify left or right (length is overall measurement).



Hemlock Rail

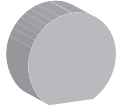

	231
	1-7/16" x 1-5/8"
	Wall Rail
8' pc ea	\$57.77
16' pc ea	\$115.54

Knotty Pine Rail

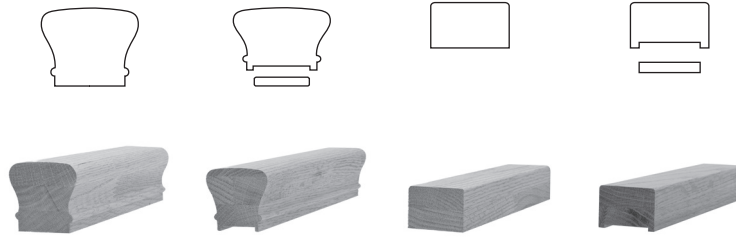

6210 Rail 2-5/8" x 2-3/8"	6210P1 Rail 2-5/8" x 2-3/8" 1-3/4" Plow Includes 6007 fillet	6770* Rail 2-1/4" x 1-9/16"	6770P1* Rail 2-1/4" x 1-9/16" 1-3/4" plow Includes 6007 fillet
---	---	---	---

6' pc	\$82.79	\$95.63	\$52.89	\$65.92
8' pc	\$110.38	\$127.50	\$70.52	\$87.90
10' pc	\$137.98	\$159.38	\$88.15	\$109.87
12' pc	\$165.58	\$191.26	\$105.79	\$131.85
14' pc	\$193.17	\$223.13	\$123.42	\$153.82
16' pc	\$220.77	\$255.01	\$141.05	\$175.80

**Handrails may not meet graspability codes. Please check local building codes before installing.*

Knotty Pine Shoe Rail, & Fillets



**6002
Shoe Rail**
2-1/4" x 7/8"
1-3/4" Plow
Includes 6007
fillet

**6007
Fillet**
1-3/4" x 3/8"

6' pc	\$41.01
8' pc	\$54.68
10' pc	\$68.35
12' pc	\$82.02
14' pc	\$95.69
16' pc	\$109.36

LF	\$2.81
-----------	--------

Knotty Pine **Balusters**

1-3/4"

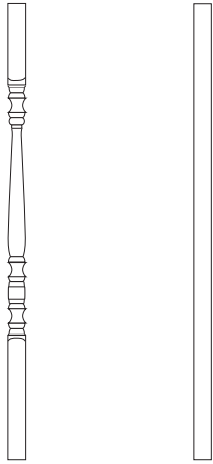

5005

5360

36"	\$35.01	\$25.17
42"	\$40.44	\$28.97

Clear Pine **Skirtboards**

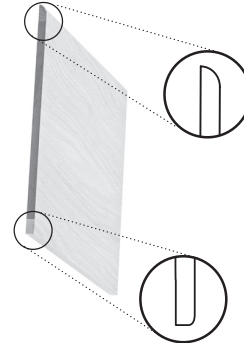

990/ Eased Edge Skirtboard

7/16" x 9-1/4"
Veneered w/
finger-joint cap

8'	\$101.92
10'	\$162.20
16'	\$203.83

Knotty Pine **Newels**

3-1/2"

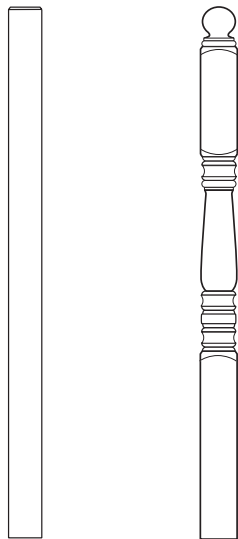

4001CH

4503

56"

56"

Full	\$152.10	\$150.69
Half	\$86.70	\$85.99

Maple Rail

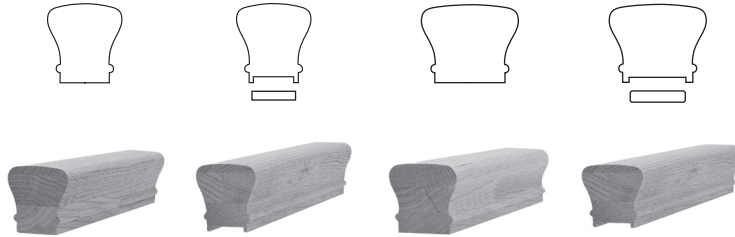

6010 Rail 2-1/4" x 2-3/8"	6010P Rail 2-1/4" x 2-3/8" 1-1/4" Plow Includes 6107 fillet	6210 Rail 2-5/8" x 2-3/8"	6210P1 Rail 2-5/8" x 2-3/8" 1-3/4" Plow Includes 6007 fillet
---	--	---	---

6' pc	\$149.29	\$177.08	\$213.87	\$262.74
8' pc	\$199.05	\$236.10	\$285.16	\$350.32
10' pc	\$248.81	\$295.13	\$356.45	\$437.90
12' pc	\$298.58	\$354.15	\$427.74	\$525.48
14' pc	\$348.34	\$413.18	\$499.03	\$613.06
16' pc	\$398.10	\$472.20	\$570.32	\$700.64
18' pc	\$447.86	\$579.84	\$664.99	\$859.83

Maple Rail

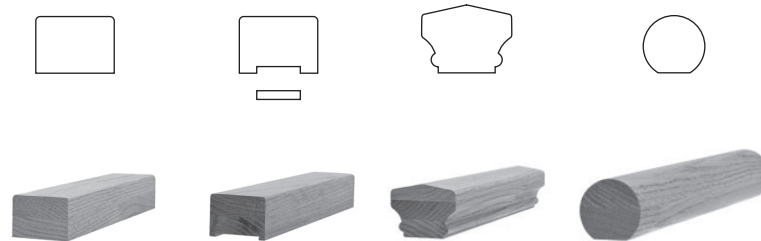

6770* Rail 2-1/4" x 1-9/16"	6770P* Rail 2-1/4" x 1-9/16" 1-1/4" Plow Includes 6107 fillet	6910 Rail 2-5/8" x 2"	6040 Rail 1-5/8" x 1-3/4"
---	--	-------------------------------------	---

6' pc	\$55.09	\$64.99	\$173.82	---
8' pc	\$73.45	\$86.65	\$231.76	\$63.45
10' pc	\$91.81	\$108.32	\$289.70	\$79.31
12' pc	\$110.17	\$129.98	\$347.64	\$95.17
14' pc	\$128.53	\$151.65	\$405.58	\$111.03
16' pc	\$146.89	\$173.31	\$463.51	\$126.90
18' pc	\$237.62	---	---	---

**Handrails may not meet graspability codes. Please check local building codes before installing.*



Maple Rail, Shoe Rail, & Fillets

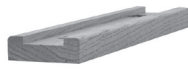

**6001
Shoe Rail**

2-1/4" x 7/8"
1-1/4" Plow
Includes 6107
fillet

**6002
Shoe Rail**

2-1/4" x 7/8"
1-3/4" Plow
Includes 6007
fillet

6' pc	\$88.73	\$94.29
8' pc	\$118.31	\$125.72
10' pc	\$147.88	\$157.15
12' pc	\$177.46	\$188.57
14' pc	\$207.04	\$220.00
16' pc	\$236.61	\$251.43

Maple Rail, Shoe Rail, & Fillets



**6007
Fillet**

1-3/4" x 3/8"

**6107
Fillet**

1-1/4" x 1/4"

LF	\$2.80	\$3.57
-----------	--------	--------

Maple Pre-Finish Recommendations

•For Field Finish situations, clear coat ONLY is recommended due to the species' natural characteristics that lead to inconsistent and blotchy appearance results. Field finished results on maple are the sole responsibility of the finisher.

•For BBW Pre-finish situations, only clear coat or Premium Process finishes will be offered. Our Premium Process helps to minimize (not eliminate) the inconsistencies for which maple is known.

Maple Balusters 1-1/4"

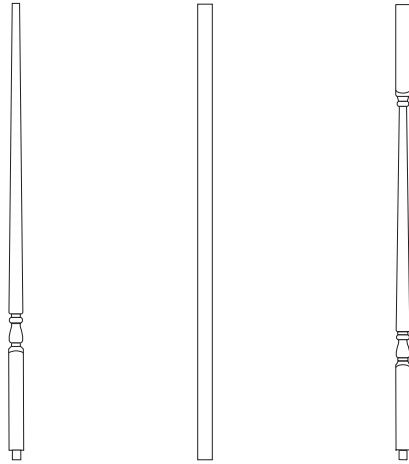

5015 5060 5070

31"	\$25.01	---	---
34"	\$26.83	---	---
36"	\$28.11	\$25.26	\$30.12
39"	\$32.04	---	---
42"	---	\$29.16	---

Maple Pre-Finish Recommendations

•For Field Finish situations, clear coat ONLY is recommended due to the species' natural characteristics that lead to inconsistent and blotchy appearance results. Field finished results on maple are the sole responsibility of the finisher.

•For BBW Pre-finish situations, only clear coat or Premium Process finishes will be offered. Our Premium Process helps to minimize (not eliminate) the inconsistencies for which maple is known.

Maple Balusters 1-3/4"

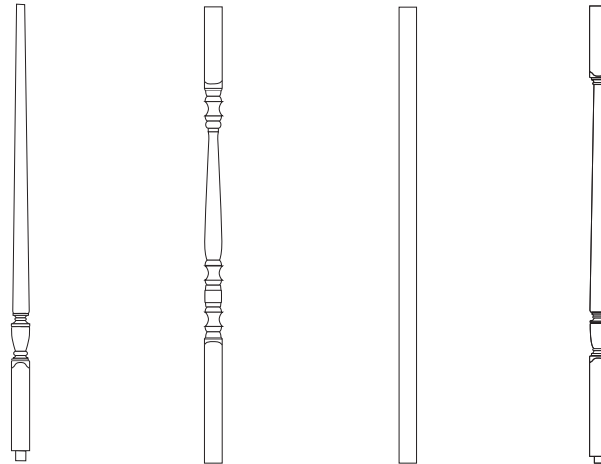

5415 5005 5360 5405

36"	\$61.42	\$59.76	\$51.55	\$64.65
39"	---	---	---	---
42"	---	\$69.53	\$59.63	---

Maple Box Newels

55" Height

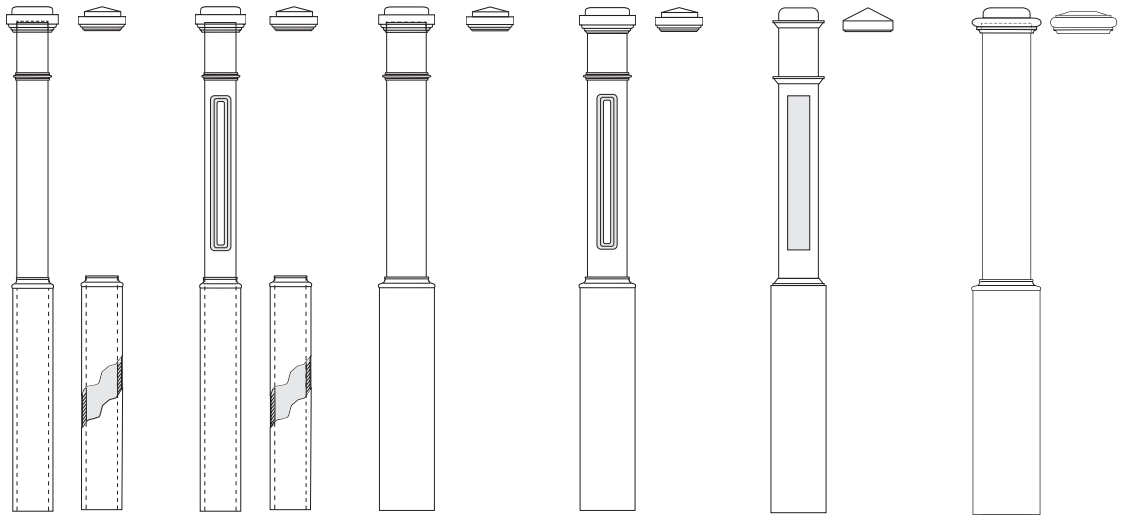

4090

Plain
3-1/2" Post
4-1/2" Base

4090RP

Raised Panel
3-1/2" Post
4-1/2" Base

4091

Plain
4-3/4" Post
6-1/4" Base

4091RP

Raised Panel
4-3/4" Post
6-1/4" Base

4092FP

Flat Panel
4-3/4" Post
6-1/4" Base

4097

Plain
6" Post
7-1/2" Base

Full	\$426.28	\$637.09	\$639.48	\$809.38	\$919.35	\$728.01
Half	\$268.71	\$385.80	\$387.13	\$481.50	\$542.58	\$436.30

The 4090 series includes an adjustable base. Two caps included with the 4090 & 4091 series.

Maple Newel Parts

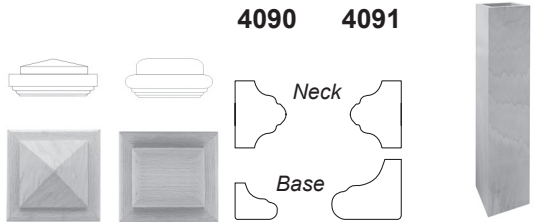

Pyramid & Square
Replacement Cap Set

Moulding Kit

Newel Sleeve

4090	\$93.42	\$28.08	\$115.14
4091	\$107.03	\$27.09	---
4097	\$146.89	---	---

4090 & 4091 Set includes, collar, pyramid & square cap

	Block 30*	Block 2 TIER**
Each	\$84.48	\$34.05

**30" mounting block allows you to tie into structural framing used with 4091 & 4092 (an 8" block sent standard with all box newels).*

***2 TIER mounting block allows you to tie into structural framing used with 4091 & 4093 (an 8" block sent standard with all box newels).*

Maple Newels

3-1/2"



4001BT
56"



4001CH
56"



4501
56"



4503
56"

Full	\$343.77	\$297.62	\$343.77	\$343.77
Half	\$182.53	\$159.46	\$182.53	\$182.53



Maple Treads - Nosing/Cove

Lineal Feet (LF)

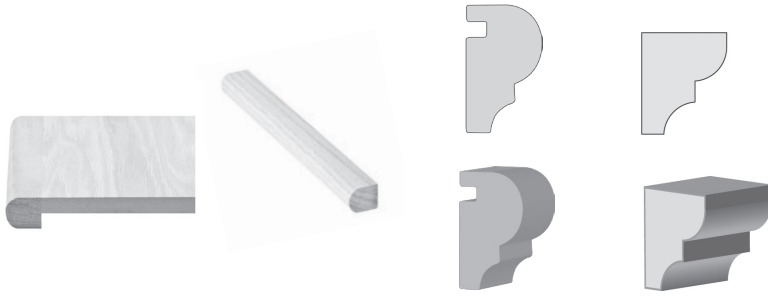

8590
Solid Landing
Tread

1-1/16" x 5-1/2"

8080
Return Nosing

1-1/32" x 1-1/4"

8081
Cove/Nosing

8181
Super Cove

5/8" x 3/4"

Random LF	\$17.79	\$5.76	\$7.22	\$3.21
Specified LF	\$22.24	\$7.20	\$9.02	\$4.01
Over 14'	\$23.13	\$7.49	---	\$4.17

Maple Rosettes

Each

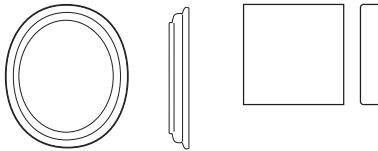

7037
Oval Rosette

3/4" x 4-1/4" x
5-3/4"

7340
Square Rosette

4" x 4"

Each	\$17.41	\$10.18
------	---------	---------

Maple Skirtboards

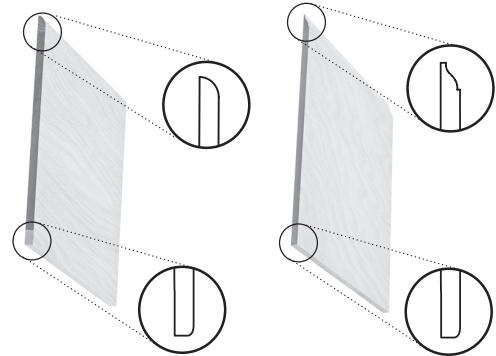

**990/Eased
Edge
Skirtboard**

7/16" x 9-1/4"
Veneered w/
finger-joint cap

**991/Eased
Edge
Skirtboard**

7/16" x 9-1/4"
Veneered w/
finger-joint cap

8'	\$77.21	\$77.21
10'	\$108.38	\$108.38
16'	\$154.42	\$154.42
18'	---	\$204.62

Maple Tread & Riser Caps

Each

8071 & 8072 Side Profile

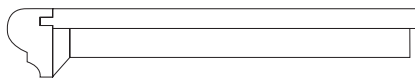

Available in Left Hand & Right Hand

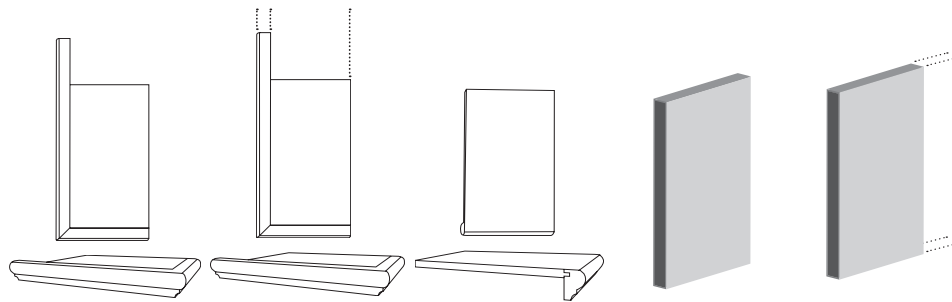

8071-06* Tread Cap	8071-16* Tread Cap	8072-06 Tread Cap	8076-06 Riser Cap	8076-16 Riser Cap
6-1/2" x 11-1/2"	16" x 11-1/2"	6-1/2" x 11-1/2"	6-1/2" x 8"	16" x 8"
Return Tread Cap w/ 6-1/2" x 8" Riser Cap	Return Tread Cap w/ 16" x 8" Riser Cap	Tread Cap w/ 6-1/2" x 8" Riser Cap		

Each	\$50.78	\$147.31	\$46.57	\$8.33	\$18.98
------	---------	----------	---------	--------	---------

*Specify left or right (length is overall measurement).

Maple Pre-Finish Recommendations

• For Field Finish situations, clear coat ONLY is recommended due to the species' natural characteristics that lead to inconsistent and blotchy appearance results. Field finished results on maple are the sole responsibility of the finisher.

• For BBW Pre-finish situations, only clear coat or Premium Process finishes will be offered. Our Premium Process helps to minimize (not eliminate) the inconsistencies for which maple is known.

Maple Treads & Risers

Each

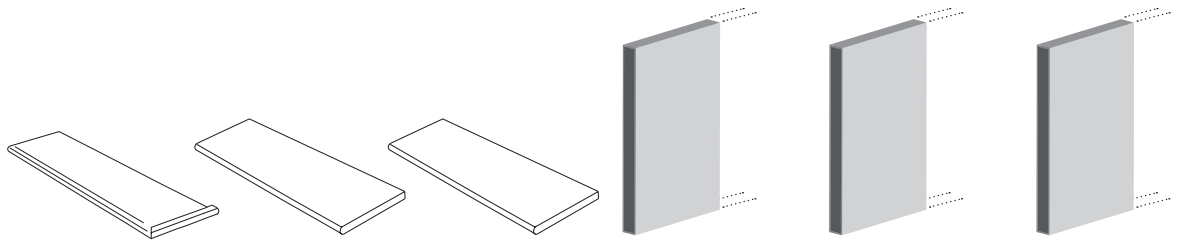

	8070-48MR* Solid Tread w/ Mitered Return 1-1/32" x 11-1/2" x 48"	8070-48 Solid Tread 1-1/32" x 11-1/2" x 48"	8070-60 Solid Tread 1-1/32" x 11-1/2" x 60"	8075-48 Solid Riser 3/4" x 7-1/2" x 48"	8075-60 Solid Riser 3/4" x 7-1/2" x 60"	8075-48MV Veneered Riser 3/4" x 7-1/2" x 48"
--	---	---	---	--	--	---

Each	\$178.19	\$151.36	\$217.45	\$105.37	\$131.95	\$40.12
------	----------	----------	----------	----------	----------	---------

*Specify left or right (length is overall measurement).

Maple Fittings for 6010 Rail

6010 Profile



	7011 Quarterturn	7012 Up Easing	7071 LH Gooseneck	7076 RH Gooseneck	7099 Gooseneck
--	----------------------------	--------------------------	--------------------------------	--------------------------------	--------------------------

Each	\$80.97	\$64.77	\$195.67	\$195.67	\$214.03
------	---------	---------	----------	----------	----------

Maple Fittings for 6210 Rail

6210 Profile

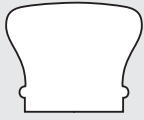

**7211
Quarterturn**

**7212
Up Easing**

**7271
LH
Gooseneck**

**7276
RH
Gooseneck**

**7299
Gooseneck**

Each	\$127.82	\$118.98	\$443.36	\$443.36	\$228.91
-------------	----------	----------	----------	----------	----------



Oak Rail, Shoe Rail, & Fillets

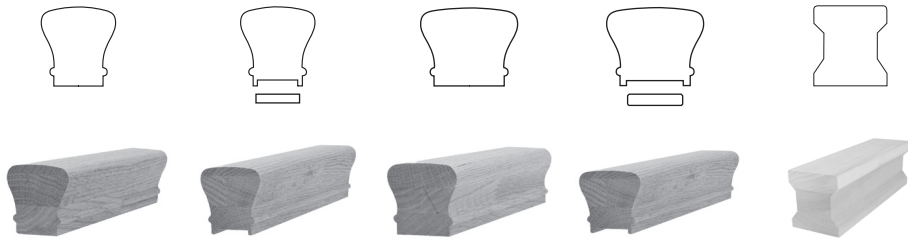

6010 Rail

2-1/4" x 2-3/8"

6010P Rail

2-1/4" x 2-3/8"
1-1/4" Plow
Includes 6107
fillet

6210 Rail

2-5/8" x 2-3/8"

6210P1 Rail

2-5/8" x 2-3/8"
1-3/4" Plow
Includes 6007
fillet

6400 Rail

2-1/4" x 2-7/16"

6' pc	\$98.12	\$132.23	\$125.91	\$143.92	\$84.43
8' pc	\$130.83	\$176.31	\$167.88	\$191.90	\$112.58
10' pc	\$163.53	\$220.39	\$209.85	\$239.87	\$140.72
12' pc	\$196.24	\$264.46	\$251.82	\$287.84	\$168.87
14' pc	\$228.95	\$308.54	\$293.79	\$335.82	\$197.01
16' pc	\$261.65	\$352.62	\$335.75	\$383.79	\$225.15
18' pc	\$294.36	\$412.79	\$377.72	\$434.77	---

Oak Rail, Shoe Rail, & Fillets

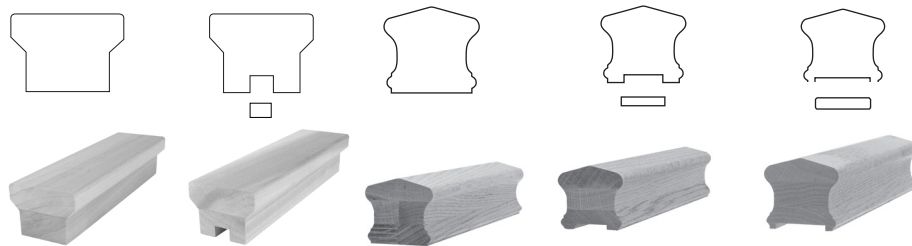

6500 Rail

2-1/4" x 1-5/8"

6500P2 Rail

2-1/4" x 1-5/8"
1/2" Plow
Includes 6207
fillet

6710 Rail

2-5/8" x 2-3/8"

6710P Rail

2-5/8" x 2-3/8"
1-1/4" Plow
Includes 6107
fillet

6710P1 Rail

2-5/8" x 2-3/8"
1-3/4" Plow
Includes 6007
fillet

6' pc	\$53.25	\$60.76	\$125.91	\$177.84	\$186.08
8' pc	\$71.01	\$81.01	\$167.88	\$237.12	\$248.11
10' pc	\$88.75	\$101.25	\$209.85	\$296.40	\$310.14
12' pc	\$106.50	\$121.53	\$251.82	\$355.68	\$372.17
14' pc	\$124.24	\$141.77	\$293.79	\$414.97	\$434.19
16' pc	\$142.02	\$162.05	\$335.75	\$474.25	\$496.22
18' pc	\$210.25	---	---	---	---

**Handrails may not meet graspability codes. Please check local building codes before installing.*

Oak Rail, Shoe Rail, & Fillets

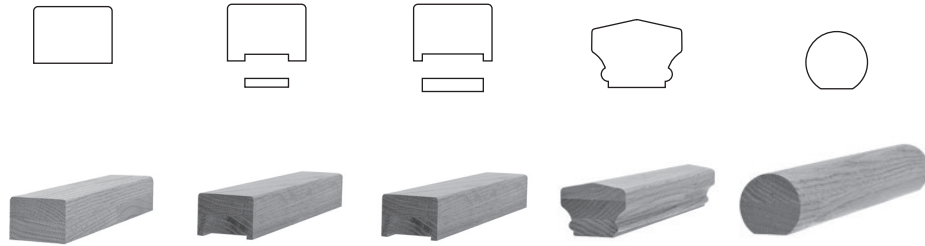

**6770*
Rail**

2-1/4" x 1-9/16"

**6770P*
Rail**

2-1/4" x 1-9/16"
1-1/4" Plow
Includes 6107
fillet

**6770P1*
Rail**

2-1/4" x 1-9/16"
1-3/4" plow
Includes 6007
fillet

**6910
Rail**

2-5/8" x 2"

**6040
Rail**

1-5/8" x 1-3/4"

6' pc	\$45.16	\$55.16	\$56.83	\$137.79	---
8' pc	\$60.21	\$73.54	\$75.76	\$183.72	\$45.24
10' pc	\$75.27	\$91.93	\$94.71	\$229.65	\$56.55
12' pc	\$90.33	\$110.32	\$113.66	\$275.58	\$67.84
14' pc	\$108.47	\$128.72	\$132.61	\$321.51	\$79.13
16' pc	\$120.42	\$147.08	\$151.52	\$367.44	\$90.47
18' pc	\$202.13	---	---	---	\$137.17

Oak Rail, Shoe Rail, & Fillets

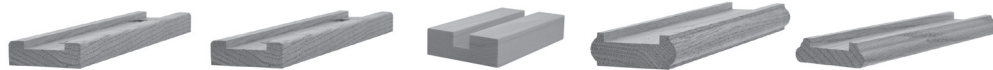

**6001
Shoe Rail**

2-1/4" x 7/8"
1-1/4" Plow
Includes 6107
fillet

**6002
Shoe Rail**

2-1/4" x 7/8"
1-3/4" Plow
Includes 6007
fillet

**6003
Shoe Rail**

2-3/8" x 3/4"
1/2" Plow
Includes 6207
fillet

**6006
Shoe Rail**

2-5/8" x 1"
1-3/4" Plow
Includes 6007
fillet

**6045
Shoe Rail**

2-1/4" x 3/4"
1-1/4" Plow
Includes 6107
fillet

6' pc	\$60.37	\$64.39	\$30.27	\$73.21	\$59.98
8' pc	\$80.49	\$85.85	\$40.36	\$97.61	\$79.98
10' pc	\$100.61	\$107.32	\$50.46	\$122.01	\$99.97
12' pc	\$120.73	\$128.78	\$60.55	\$146.41	\$119.97
14' pc	\$140.86	\$150.25	\$70.64	\$170.82	\$139.96
16' pc	\$160.98	\$171.71	\$80.70	\$195.22	\$159.96



**6007
Fillet**

1-3/4" x 3/8"

**6107
Fillet**

1-1/4" x 1/4"

**6207
Fillet**

1/2" x 3/8"

LF	\$2.27	\$2.12	\$1.26
----	--------	--------	--------

Oak Balusters

1-1/4"

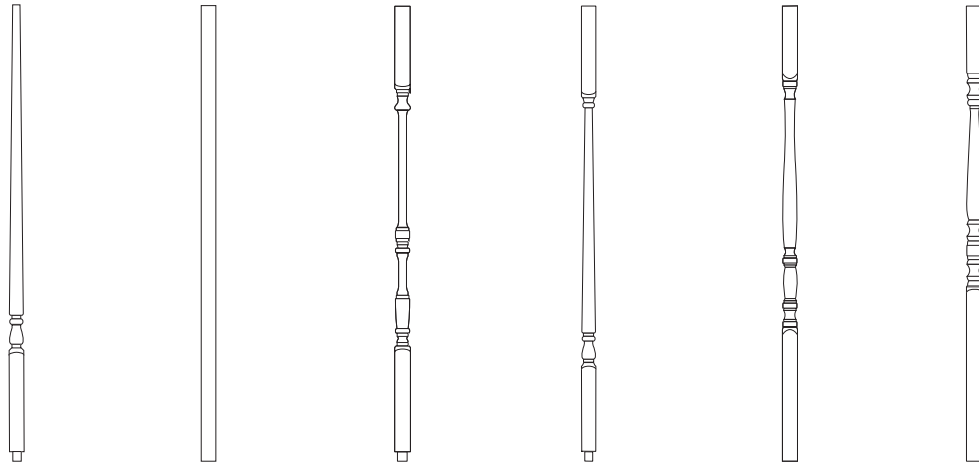

5015 5060 5067 5070 5109 5105

31"	\$14.72	---	\$18.01	---	---	---
34"	\$15.75	---	---	---	---	---
36"	\$16.70	\$13.03	\$19.87	\$19.87	\$18.33	\$19.87
39"	\$19.23	---	\$21.05	\$21.05	---	---
42"	\$20.22	\$20.51	\$23.32	\$23.32	\$22.58	---

Oak Balusters

1-3/4"

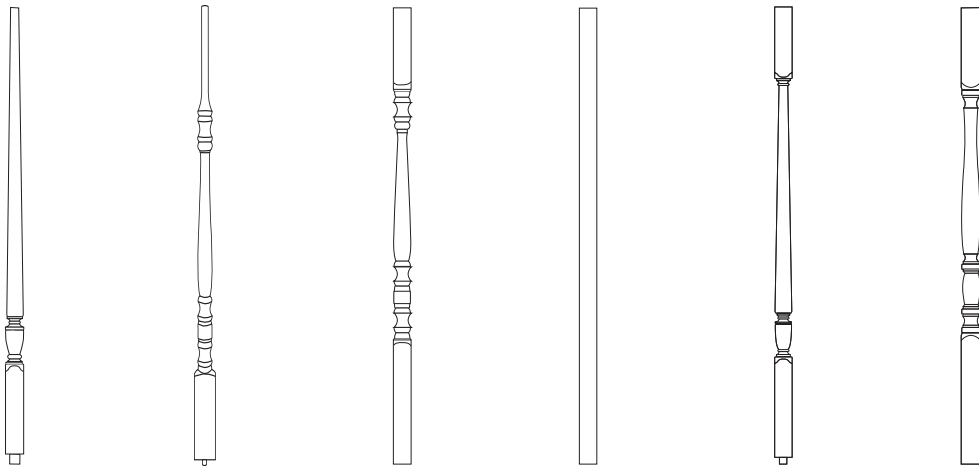

5415 5611 5005 5360 5405 5905

32"	\$45.45	\$45.45	\$34.59	---	---	---
36"	\$49.44	\$49.44	\$36.99	\$31.43	\$55.42	\$51.10
39"	---	---	---	---	\$59.28	---
42"	---	\$57.56	\$44.01	\$42.74	---	\$61.01

Oak Box Newels

55" Height

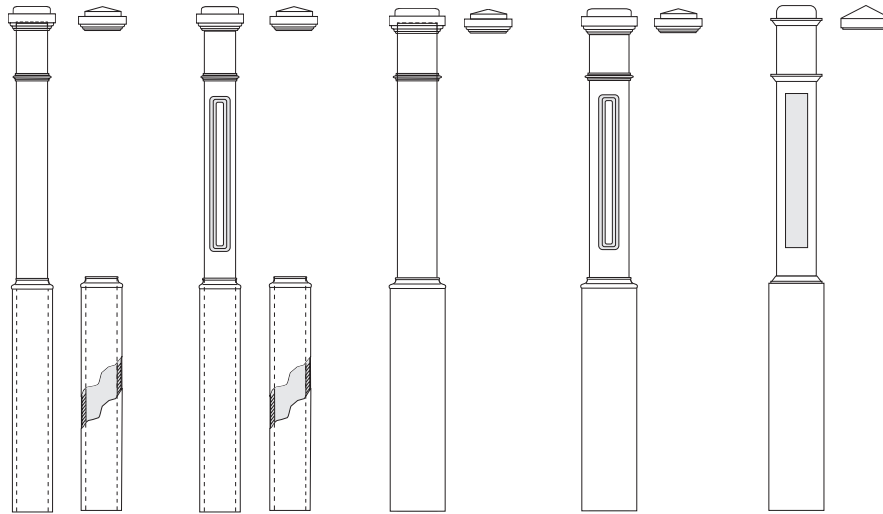

4090 Plain 3-1/2" Post 4-1/2" Base	4090RP Raised Panel 3-1/2" Post 4-1/2" Base	4091 Plain 4-3/4" Post 6-1/4" Base	4091RP Raised Panel 4-3/4" Post 6-1/4" Base	4092FP Flat Panel 4-3/4" Post 6-1/4" Base
--	---	--	---	---

Full	\$435.34	\$505.12	\$371.36	\$616.36	\$714.52
Half	\$273.74	\$312.50	\$238.21	\$374.29	\$428.81

The 4090 series includes an adjustable base. Two caps included with the 4090 & 4091 series.

Oak Box Newels

55" Height

47-1/2"

59-1/2"

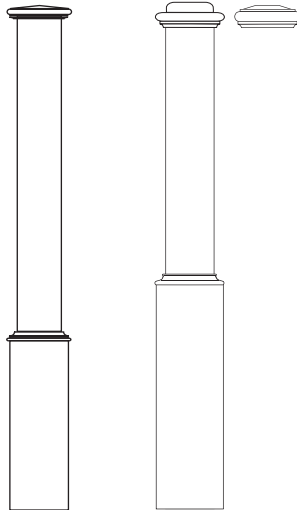

4093 Plain Panel 4-3/4" Post 6-1/4" Base	4097 Plain 6" Post 7-1/2" Base
--	--

Full	\$387.81	\$590.63
Half	\$247.34	\$360.00

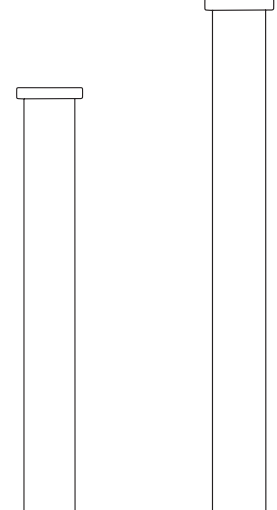

4095 Plain 5" Post	4096 Plain 5" Post
---------------------------------	---------------------------------

Full	\$284.86	\$302.86
Half	\$190.16	\$200.16

Oak Newel Parts

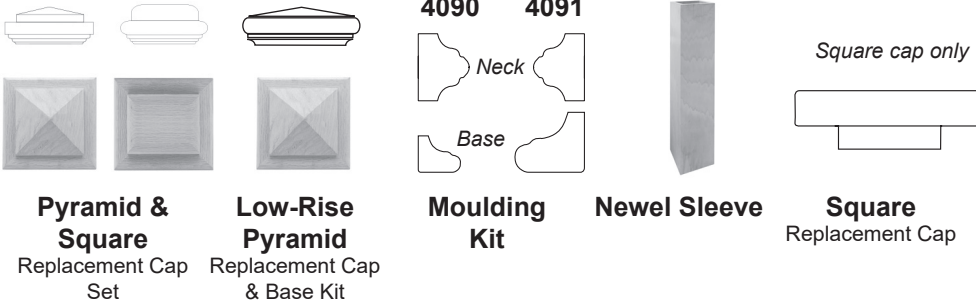

4090	\$72.63	---	\$20.22	\$93.58	---
4091	\$87.20	---	\$20.58	---	---
4093	---	\$84.74	---	---	---
4095/4096	---	---	---	---	\$66.19
4097	\$116.65	---	---	---	---

4090 & 4091
Set includes:
collar, pyramid &
square cap



	Block 30*	Block 2 TIER**
Each	\$84.48	\$34.05

*30" mounting block allows you to tie into structural framing used with 4091 & 4092 (an 8" block sent standard with all box newels).

**2 TIER mounting block allows you to tie into structural framing used with 4091 & 4093 (an 8" block sent standard with all box newels).

Oak Newels

3"

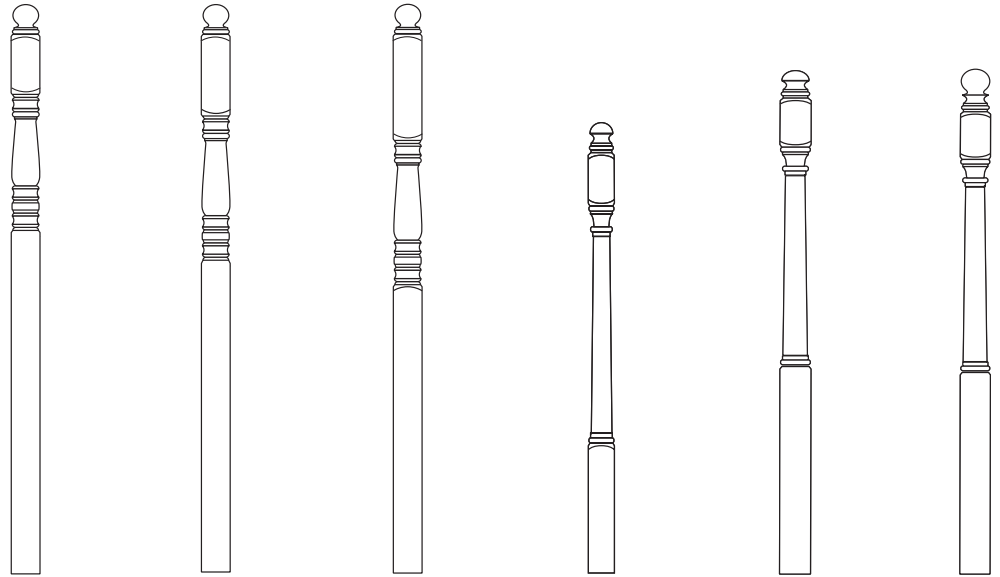

3501
60"

3503
60"

3505
60"

4040
47-1/2"

4042
53-1/2"

4042BT
53-1/2"

Full	\$220.55	\$176.02	\$220.55	\$123.58	\$164.65	\$164.65
Half	\$120.92	\$98.66	\$120.92	\$72.43	\$92.97	\$92.97

Oak Newels

3"

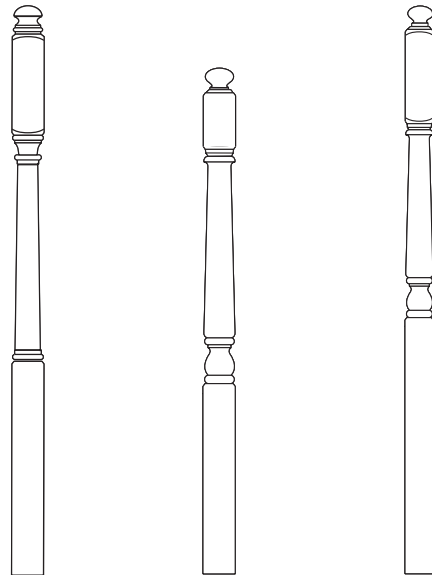

4045
60"

4640
53-1/2"

4641
60"

Full	\$188.64	\$143.54	\$182.47
Half	\$104.97	\$82.42	\$101.88

Oak Newels

3-1/2"

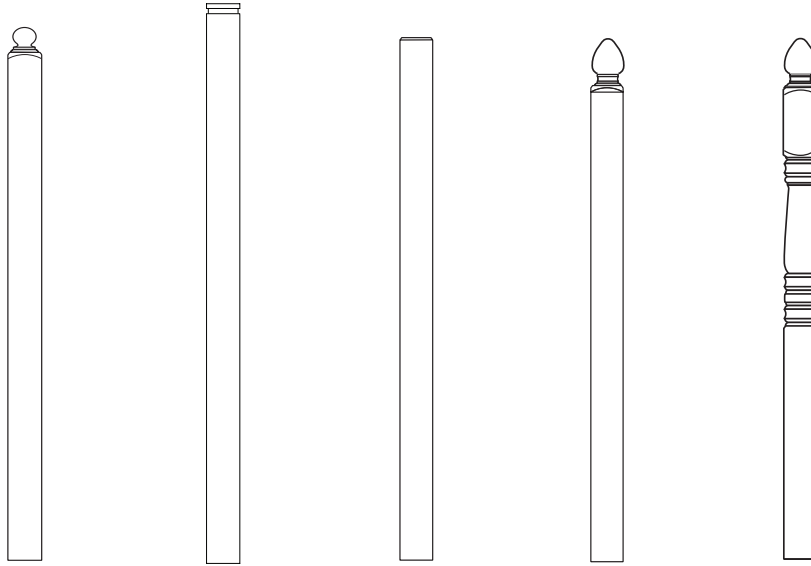

4001BT

56"

4001CG

59-1/2"

4001CH

56"

4005

56"

4242

56"

Full	\$244.69	\$240.12	\$176.82	\$228.63	\$250.25
Half	\$132.99	\$130.71	\$99.06	\$124.96	\$135.77

Oak Newels

3-1/2"

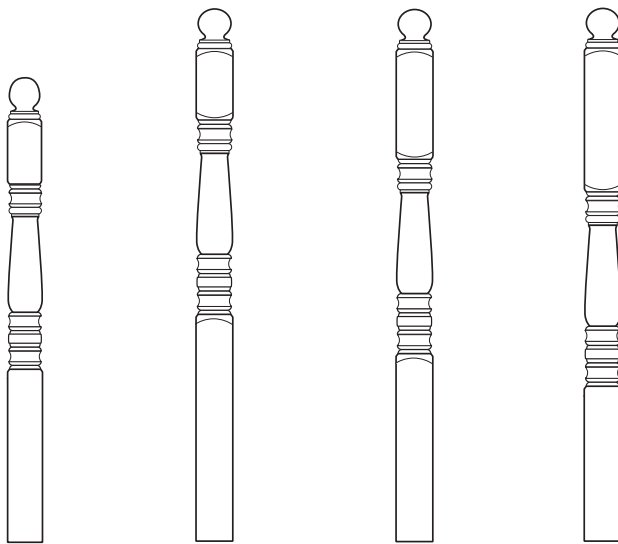

4500

48"

4501

56"

4503

56"

4505

56"

Full	\$199.08	\$221.66	\$250.25	\$236.42
Half	\$110.19	\$121.48	\$135.77	\$128.86

Oak Treads - Nosing/Cove Lineal Feet (LF)



8090 Solid Landing Tread	8590 Solid Landing Tread	8590SE Square Eased Edge Landing Tread	8080 Return Nosing	8080SE Square Eased Edge Nosing
1-1/16" x 3-1/2"	1-1/16" x 5-1/2"	1-1/16" x 5-1/2"	1-1/32" x 1-1/4"	1" x 1-1/4"

Random LF	\$7.52	\$11.09	\$11.65	\$3.23	\$4.82
Specified LF	\$9.41	\$13.87	\$14.56	\$4.04	\$6.03
Over 14'	\$9.78	\$14.42	\$15.15	\$4.20	---

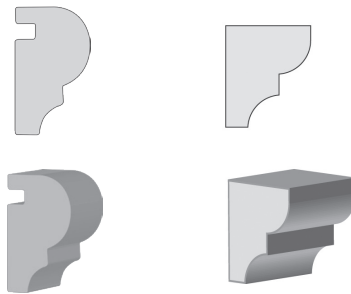

8081 Nosing/Cove	8181 Super Cove
1-1/8" x 1-13/16"	5/8" x 3/4"

Random LF	\$5.33	\$2.03
Specified LF	\$6.67	\$2.53
Over 14'	---	\$2.63

Oak Rosettes - Tread Brackets Each

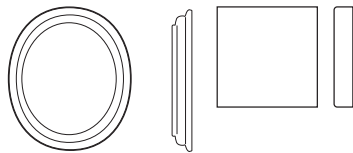

7037 Oval Rosette	7340 Square Rosette
3/4" x 4-1/4" x 5-3/4"	4" x 4"

Each	\$9.20	\$8.64
------	--------	--------

Oak Tread & Riser Caps

Each

8071 & 8072 Side Profile

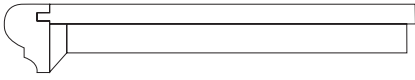

Available in Left Hand & Right Hand

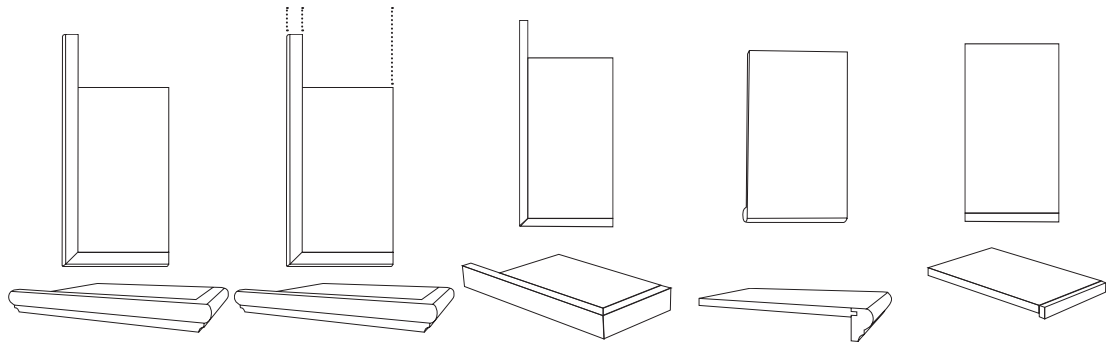

- | | | | | |
|---|---|--|---|--|
| <p>8071-06*
Tread Cap
6-1/2" x 11-1/2"
Return Tread Cap w/
6-1/2" x 8" Riser Cap</p> | <p>8071-16*
Tread Cap
16" x 11-1/2" Return
Tread Cap w/ 16" x 8"
Riser Cap</p> | <p>8071SE-06*
Tread Cap
6-1/2" x 11-1/2"
Squared Eased Edge
Return Tread Cap w/
6-1/2" x 8" Riser Cap</p> | <p>8072-06
Tread Cap
6-1/2" x 11-1/2" Tread
Cap w/ 6-1/2" x 8"
Riser Cap</p> | <p>8072SE-06
Tread Cap
6-1/2" x 11-1/2"
Squared Eased Edge
Tread Cap w/ 6-1/2" x
8" Riser Cap</p> |
|---|---|--|---|--|

Each	\$49.92	\$122.71	\$49.92	\$41.81	\$41.81
------	---------	----------	---------	---------	---------

*Specify left or right (length is overall measurement).



8076-06
Riser Cap
6-1/2" x 8"

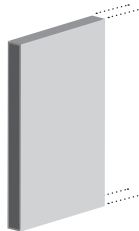

8076-16
Riser Cap
16" x 8"

Each	\$7.41	\$17.44
------	--------	---------



Oak Treads & Risers

Each

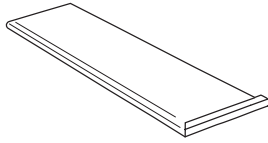

8070-48MR*
Solid Tread

w/ Mitered Return
1-1/32" x 11-1/2"
x 48"

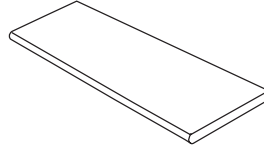

8070-60MR*
Solid Tread

w/ Mitered Return
1-1/32" x 11-1/2"
x 60"

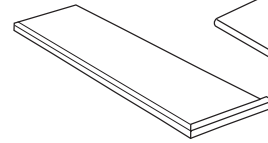

8070-48
Solid Tread

1-1/32" x 11-1/2"
x 48"

8070-60
Solid Tread

1-1/32" x 11-1/2"
x 60"

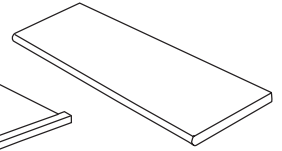

8070SE-48MR*
Square Eased
Edge Tread w/
Mitered Return

1-1/32" x 11-1/2"
x 48"

8070SE-48
Square Eased
Edge Tread

1-1/32" x 11-1/2"
x 48"

Each	\$97.61	\$170.37	\$94.29	\$160.59	\$119.81	\$107.77
------	---------	----------	---------	----------	----------	----------

*Specify left or right (length is overall measurement).

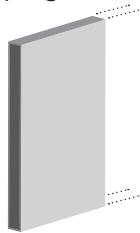

8075-48
Solid Riser

3/4" x 7-1/2" x 48"

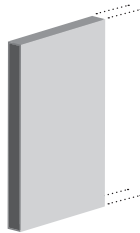

8075-60
Solid Riser

3/4" x 7-1/2" x 60"

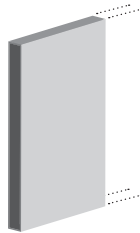

8075-48KV
Veneered Riser

3/4" x 7-1/2" x 48"

Each	\$66.26	\$99.44	\$39.50
------	---------	---------	---------

Oak Skirtboards

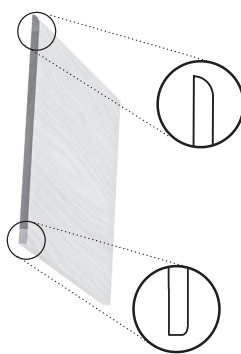

990/Eased
Edge
Skirtboard

7/16" x 9-1/4"
Veneered w/
finger-joint cap

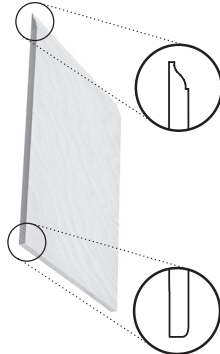

991/Eased
Edge
Skirtboard

7/16" x 9-1/4"
Veneered w/
finger-joint cap

8'	\$77.21	\$77.21
10'	\$108.38	\$108.38
16'	\$154.42	\$154.42
18'	\$191.25	\$169.24

Oak Fittings for 6010 Rail

6010 Profile



7011
Quarterturn

7012
Up Easing

7071
LH
Gooseneck

7076
RH
Gooseneck

7099
Gooseneck

Each	\$43.37	\$44.62	\$115.66	\$115.66	\$92.21
------	---------	---------	----------	----------	---------

Oak Fittings for 6210 Rail

6210 Profile

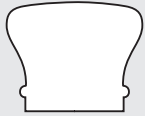

7211
Quarterturn

7212
Up Easing

7271
LH
Gooseneck

7276
RH
Gooseneck

7299
Gooseneck

Each	\$48.93	\$50.69	\$135.49	\$128.72	\$106.94
------	---------	---------	----------	----------	----------

Poplar Rail

Green tints and small pin knots are acceptable characteristics of stain grade Poplar and are not considered defects.



6010 Rail 2-1/4" x 2-3/8"	6010P Rail 2-1/4" x 2-3/8" 1-1/4" Plow Includes 6107 fillet	6210 Rail 2-5/8" x 2-3/8"	6210P1 Rail 2-5/8" x 2-3/8" 1-3/4" Plow Includes 6007 fillet	6400 Rail 2-1/4" x 2-7/16"
-------------------------------------	---	-------------------------------------	--	--------------------------------------

6' pc	\$80.30	\$94.48	\$105.79	\$124.76	\$88.52
8' pc	\$107.06	\$125.97	\$141.05	\$166.34	\$118.04
10' pc	\$133.83	\$157.46	\$176.31	\$207.93	\$147.54
12' pc	\$160.59	\$188.96	\$211.57	\$249.52	\$177.04
14' pc	\$187.36	\$220.45	\$246.83	\$291.10	\$206.58
16' pc	\$214.13	\$251.94	\$282.09	\$332.69	\$236.05
18' pc	\$347.25	\$301.99	\$317.36	\$376.03	---

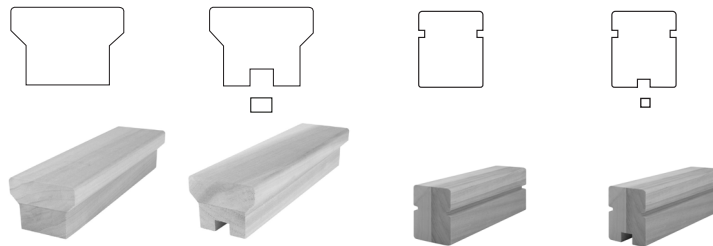

6500 Rail 2-1/4" x 1-5/8"	6500P2 Rail 2-1/4" x 1-5/8" 1/2" Plow Includes 6207 fillet	6570* Rail 1-11/16" x 2"	6570P2* Rail 1-11/16" x 2" 1/2" Plow Includes 6207 fillet
-------------------------------------	--	------------------------------------	---

6' pc	\$55.98	\$63.73	\$73.32	\$81.86
8' pc	\$74.65	\$84.96	\$97.73	\$109.15
10' pc	\$93.32	\$106.22	\$122.17	\$136.46
12' pc	\$111.96	\$127.45	\$146.65	\$163.71
14' pc	\$130.63	\$148.68	\$171.06	\$191.05
16' pc	\$149.27	\$169.92	\$195.50	\$218.37
18' pc	\$188.31	---	---	---

**Handrails may not meet graspability codes. Please check local building codes before installing.*



Poplar Rail

Green tints and small pin knots are acceptable characteristics of stain grade Poplar and are not considered defects.

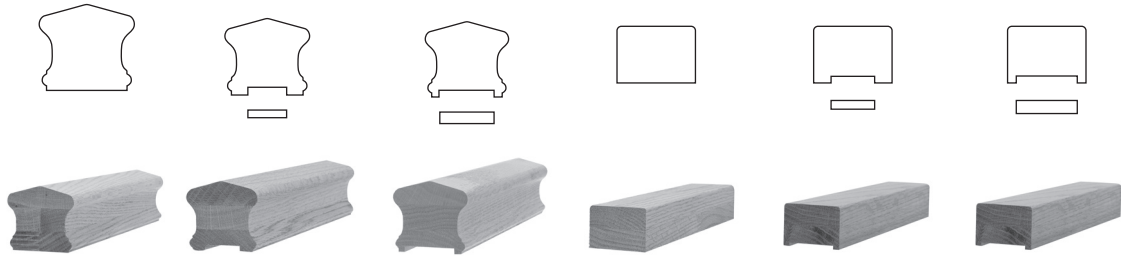

6710 Rail

2-5/8" x 2-3/8"

6710P Rail

2-5/8" x 2-3/8"
1-1/4" Plow
Includes 6107 fillet

6710P1 Rail

2-5/8" x 2-3/8"
1-3/4" Plow
Includes 6007 fillet

6770* Rail

2-1/4" x 1-9/16"

6770P* Rail

2-1/4" x 1-9/16"
1-1/4" Plow
Includes 6107 fillet

6770P1* Rail

2-1/4" x 1-9/16"
1-3/4" plow
Includes 6007 fillet

6' pc	\$128.40	\$146.41	\$162.70	\$57.88	\$65.16	\$114.98
8' pc	\$171.20	\$195.22	\$216.94	\$77.17	\$86.88	\$153.31
10' pc	\$214.00	\$244.02	\$271.17	\$96.46	\$108.60	\$191.64
12' pc	\$256.80	\$292.83	\$325.41	\$115.75	\$130.32	\$229.97
14' pc	\$299.60	\$341.63	\$379.64	\$135.04	\$152.03	\$268.30
16' pc	\$342.40	\$390.44	\$433.87	\$154.33	\$173.75	\$306.62
18' pc	---	---	---	\$175.22	---	---

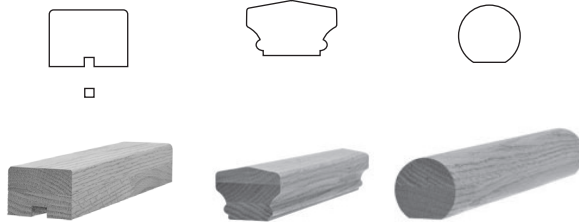

6770P2 Rail

2-1/4" x 1-9/16"
1/2" Plow
Includes 6207 fillet

6910 Rail

2-5/8" x 2"

6040 Rail

1-5/8" x 1-3/4"

6' pc	\$67.03	\$131.47	---
8' pc	\$92.52	\$175.29	\$66.55
10' pc	\$111.81	\$219.11	\$83.08
12' pc	\$134.06	\$262.93	\$99.70
14' pc	\$156.40	\$306.75	\$116.41
16' pc	\$178.74	\$350.57	\$133.09
18' pc	---	---	\$164.74

**Handrails may not meet graspability codes. Please check local building codes before installing.*

Available in stock Pre-Finish colors. Refer to Pre-Finish Products section for specific color, sizes and pricing options.

Poplar Shoe Rail & Fillets

Green tints and small pin knots are acceptable characteristics of stain grade Poplar and are not considered defects.

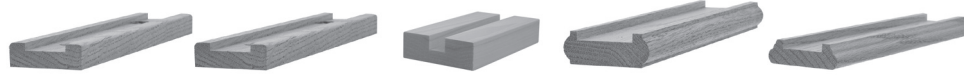

6001 Shoe Rail	6002 Shoe Rail	6003 Shoe Rail	6006 Shoe Rail	6045 Shoe Rail
2-1/4" x 7/8" 1-1/4" Plow Includes 6107 fillet	2-1/4" x 7/8" 1-3/4" Plow Includes 6007 fillet	2-3/8" x 3/4" 1/2" Plow Includes 6207 fillet	2-5/8" x 1" 1-3/4" Plow Includes 6007 fillet	2-1/4" x 3/4" 1-1/4" Plow Includes 6107 fillet

6' pc	\$63.24	\$65.92	\$36.92	\$75.12	\$53.47
8' pc	\$84.32	\$87.90	\$49.22	\$100.16	\$71.29
10' pc	\$105.40	\$109.87	\$61.53	\$125.21	\$89.11
12' pc	\$126.48	\$131.85	\$73.85	\$150.25	\$106.94
14' pc	\$147.56	\$153.82	\$86.16	\$175.29	\$124.76
16' pc	\$168.64	\$175.80	\$98.41	\$200.33	\$142.58



6007 Fillet	6107 Fillet	6207 Fillet
1-3/4" x 3/8"	1-1/4" x 1/4"	1/2" x 3/8"

LF	\$2.23	\$1.79	\$1.29
----	--------	--------	--------

Poplar Balusters

1-1/4"

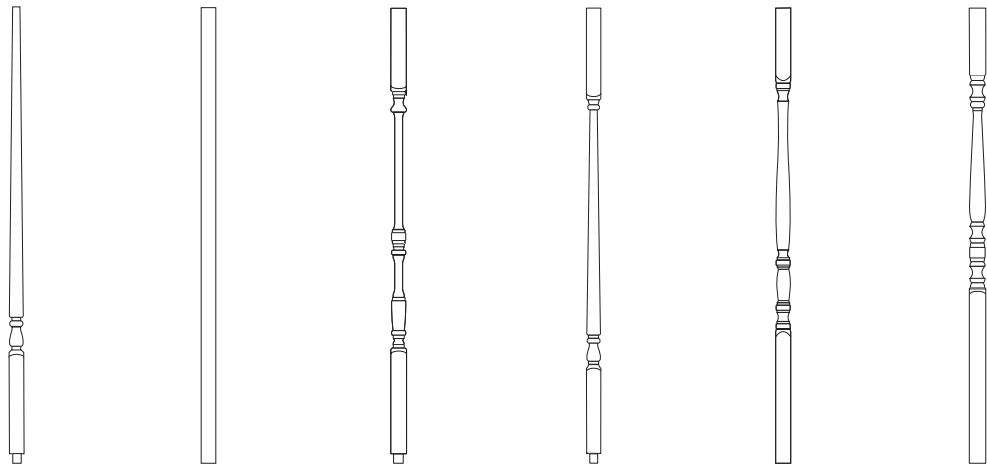

	5015	5060	5067	5070	5109	5105
--	------	------	------	------	------	------

31"	\$13.77	---	\$17.82	---	---	---
34"	\$14.63	---	---	---	---	---
36"	\$15.17	\$10.76	\$19.26	\$19.26	\$22.10	\$18.65
39"	\$16.70	---	---	---	---	---
42"	\$20.70	\$13.57	---	\$23.25	\$26.35	\$22.26

Poplar Balusters

1-3/4"

Green tints and small pin knots are acceptable characteristics of stain grade Poplar and are not considered defects.

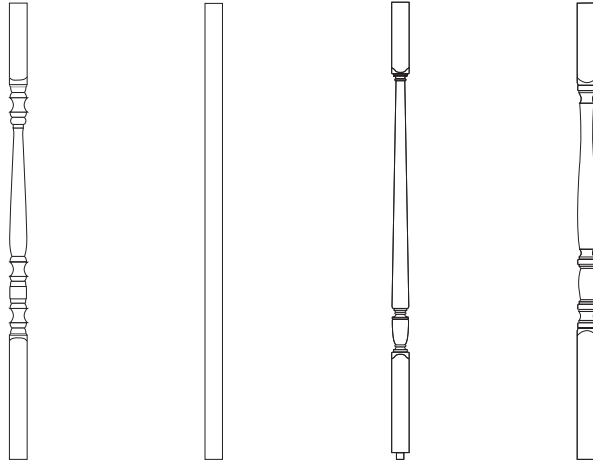

5005 5360 5405 5905

32"	---	---	\$36.51	---
36"	\$32.55	\$24.56	\$38.93	\$38.93
39"	---	---	\$41.36	---
42"	\$42.64	\$28.30	---	---

Poplar Box Newels

55" Height

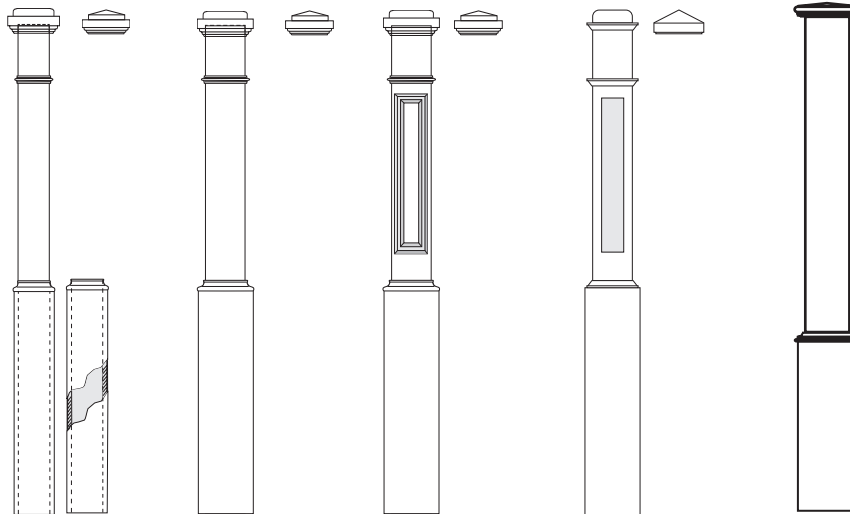

4090 4091 4091RP 4092FP 4093
 Plain Plain Raised Panel Flat Panel Plain Panel
 3-1/2" Post 4-3/4" Post 4-3/4" Post 4-3/4" Post 4-3/4" Post
 4-1/2" Base 6-1/4" Base 6-1/4" Base 6-1/4" Base 6-1/4" Base

Full	\$366.42	\$474.24	\$700.87	\$751.73	\$403.77
Half	\$235.46	\$295.35	\$421.23	\$449.48	\$256.21

The 4090 series includes an adjustable base. Two caps included with the 4090 & 4091 series.

Poplar Box Newels 55" Height

Green tints and small pin knots are acceptable characteristics of stain grade Poplar and are not considered defects.

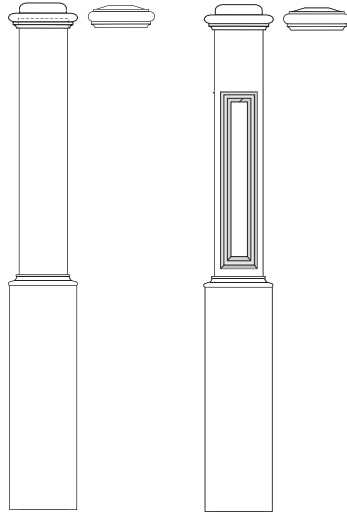

4097

Plain
6" Post
7-1/2" Base

4097RP

Raised Panel
6" Post
7-1/2" Base

Full	\$649.17	\$823.41
Half	\$392.51	\$489.29

47-1/2"

59-1/2"

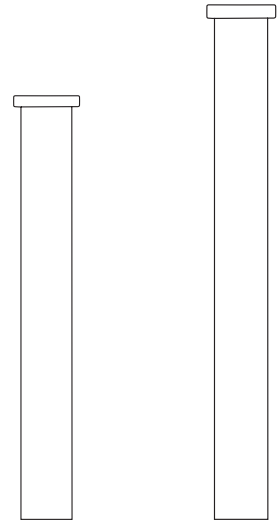

4095

Plain
5" Post

4096

Plain
5" Post

Full	\$295.33	\$369.39
Half	\$195.98	\$237.11

Poplar Newel Parts

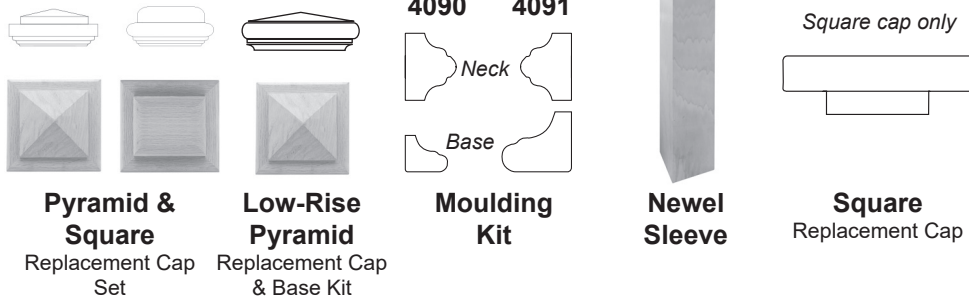

Pyramid & Square

Replacement Cap Set

Low-Rise Pyramid

Replacement Cap & Base Kit

Moulding Kit

Newel Sleeve

Square Replacement Cap

4090	\$74.01	---	\$24.66	\$117.51	---
4091	\$90.42	---	\$21.06	---	---
4093	---	\$90.39	---	---	---
4095/4096	---	---	---	---	\$63.66
4097	\$131.24	---	---	---	---

4090 & 4091 Set includes, collar, pyramid & square cap



	Block 30*	Block 2 TIER**
Each	\$84.48	\$34.05

**30" mounting block allows you to tie into structural framing used with 4091 & 4092 (an 8" block sent standard with all box newels).*

***2 TIER mounting block allows you to tie into structural framing used with 4091 & 4093 (an 8" block sent standard with all box newels).*

Poplar Newels 3"

Poplar Newels 3-1/2"

Green tints and small pin knots are acceptable characteristics of stain grade Poplar and are not considered defects.

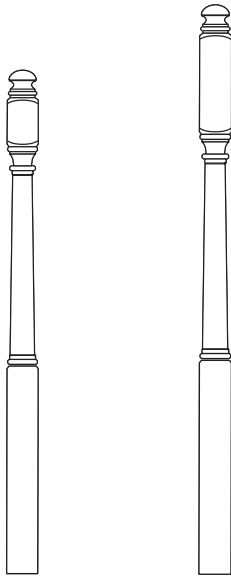

4042
53-1/2"

4045
60"

Full	\$148.71	\$168.10
Half	\$85.00	\$94.70

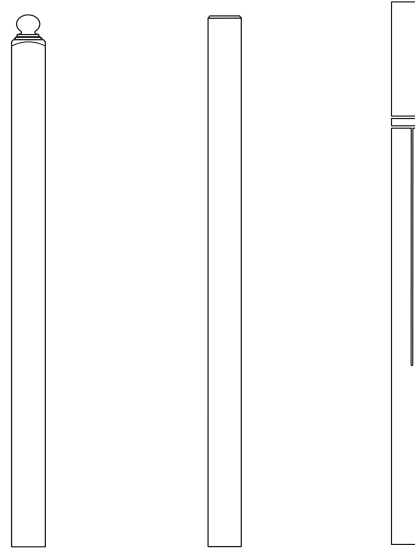

4001BT
56"

4001CH
56"

4001DC
59-1/2"

\$168.84	\$176.69	\$190.56
\$95.06	\$98.99	\$105.93

Poplar Newels 3-1/2"

3-1/2"

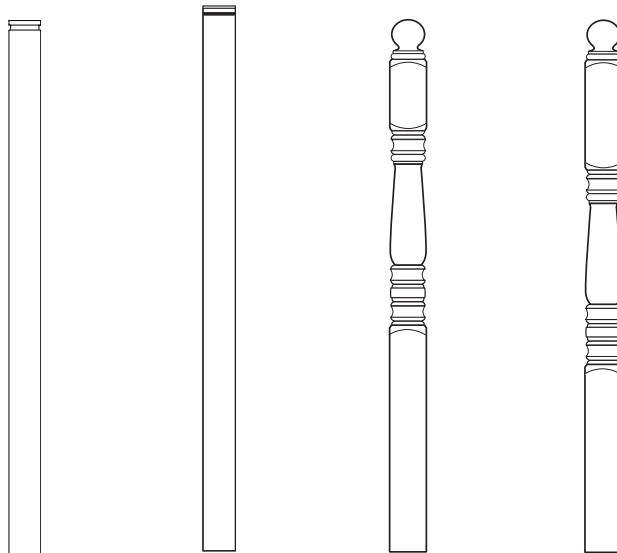

4001CG
59-1/2"

4001SG
59-1/2"

4501
56"

4503
56"

Full	\$234.54	\$190.56	\$191.16	\$191.16
Half	\$127.91	\$105.93	\$106.23	\$106.23

Poplar Treads - Nosing/Cove

Lineal Feet (LF)

Green tints and small pin knots are acceptable characteristics of stain grade Poplar and are not considered defects.

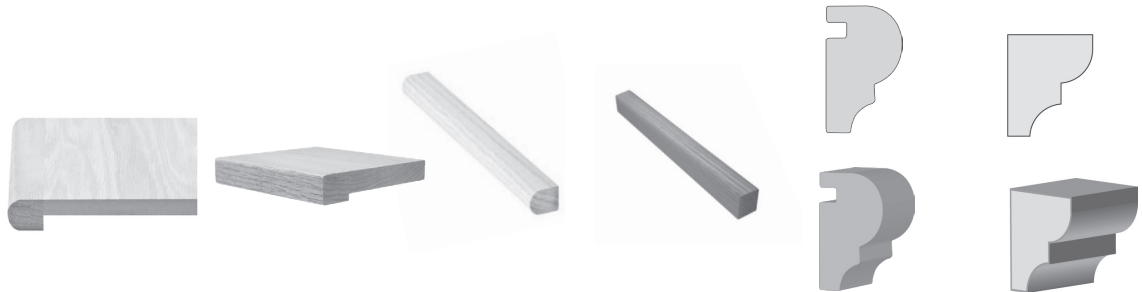

8590
Solid Landing
Tread

1-1/16" x 5-1/2"

8590SE
Square Eased
Edge Landing

1-1/16" x 5-1/2"

8080
Return Nosing

1-1/32" x 1-1/4"

8080SE
Square Eased
Edge Nosing

1" x 1-1/4"

8081
Cove/Nosing

1-1/8" x 1-13/16"

8181
Super Cove

5/8" x 3/4"

Random LF	\$12.17	\$12.16	\$3.18	\$3.99	\$5.85	\$1.99
Specified LF	\$15.22	\$15.20	\$3.97	\$4.99	\$7.31	\$2.48
Over 14'	\$15.83	\$15.81	\$4.13	---	---	\$2.58

Poplar Skirtboards

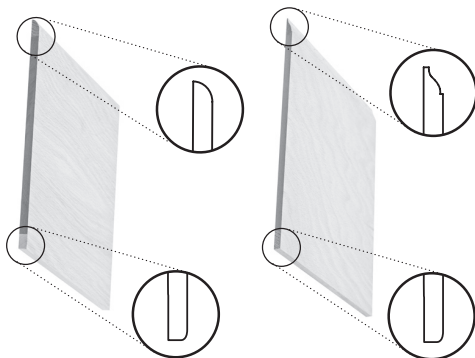

**990/Eased
Edge
Skirtboard**

7/16" x 9-1/4"
Veneered w/
finger-joint cap

**991/Eased
Edge
Skirtboard**

7/16" x 9-1/4"
Veneered w/
finger-joint cap

8'	\$68.51	\$68.51
10'	\$105.20	\$105.20
16'	\$137.02	\$137.02
18'	\$181.64	\$181.64

Poplar Rosettes - Tread Brackets

Each

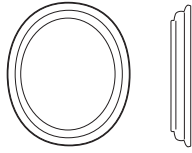

7037
Oval Rosette

3/4" x 4-1/4" x 5-3/4"



7340
Square Rosette

4" x 4"

Green tints and small pin knots are acceptable characteristics of stain grade Poplar and are not considered defects.

Each	\$21.53	\$8.02
------	---------	--------

Poplar Tread & Riser Caps

Each

8071 & 8072 Side Profile

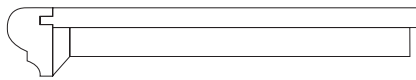

Available in Left Hand & Right Hand

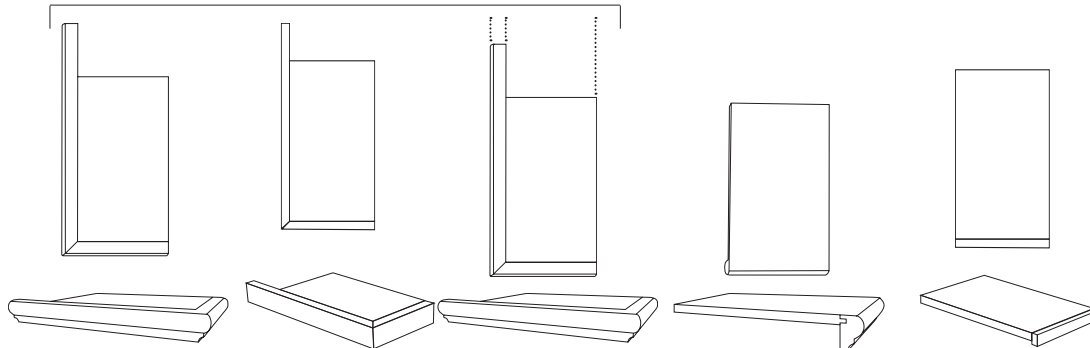

8071-06*
Tread Cap

6-1/2" x 11-1/2"
Return Tread Cap w/
6-1/2" x 8" Riser Cap

8071SE-06*
Tread Cap

6-1/2" x 11-1/2"
Squared Eased Edge
Return Tread Cap w/
6-1/2" x 8" Riser Cap

8071-16
Tread Cap

16" x 11-1/2" Return
Tread Cap w/ 16" x 8"
Riser Cap

8072-06
Tread Cap

6-1/2" x 11-1/2" Tread
Cap w/ 6-1/2" x 8"
Riser Cap

8072SE-06
Tread Cap

6-1/2" x 11-1/2"
Squared Eased Edge
Tread Cap w/ 6-1/2" x
8" Riser Cap

Each	\$29.75	\$29.75	\$136.93	\$20.83	\$20.83
------	---------	---------	----------	---------	---------

*Specify left or right (length is overall measurement).



8076-06
Riser Cap

6-1/2" x 8"

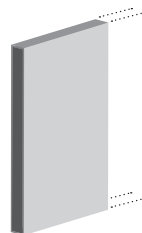

8076-16
Riser Cap

16" x 8"

Each	\$7.10	\$16.97
------	--------	---------

Poplar Fittings for **6010 Rail**

6010 Profile



Green tints and small pin knots are acceptable characteristics of stain grade Poplar and are not considered defects.



	7011 Quarterturn	7012 Up Easing	7071 LH Gooseneck	7076 RH Gooseneck	7099 Gooseneck
Each	\$54.94	\$51.10	\$133.61	\$133.61	\$100.42

Poplar Fittings for **6210 Rail**

6210 Profile



	7211 Quarterturn	7212 Up Easing	7271 LH Gooseneck	7276 RH Gooseneck	7299 Gooseneck
Each	\$60.62	\$57.30	\$150.89	\$150.89	\$117.54

Primed **Balusters**

1-1/4"

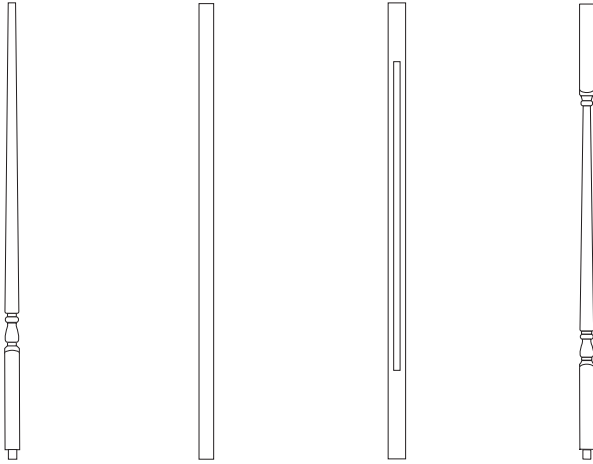

5015 5060 5061 5070

31"	\$8.98	---	---	---
34"	\$9.39	---	---	---
36"	\$10.96	\$11.97	\$16.13	\$13.48
39"	\$11.18	---	---	\$13.70
42"	\$12.23	\$13.92	\$19.80	\$15.40

Primed **Balusters**

1-3/4"

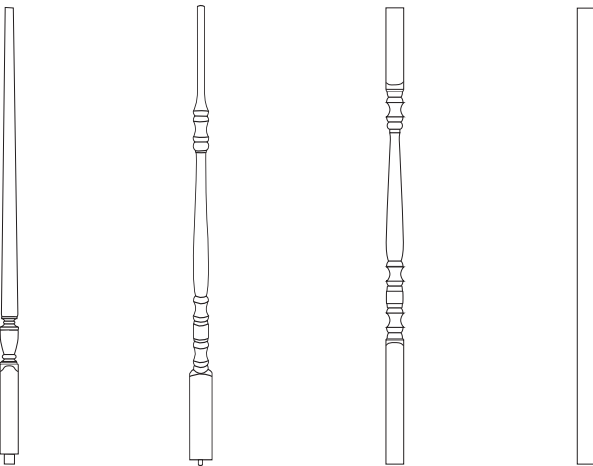

5415 5611 5005 5360

32"	---	---	\$19.93	---
36"	\$26.51	\$22.52	\$22.17	\$18.15
39"	\$29.74	---	---	---
42"	\$34.02	\$26.29	\$24.75	\$20.37

Primed **Box Newels** 55" Height

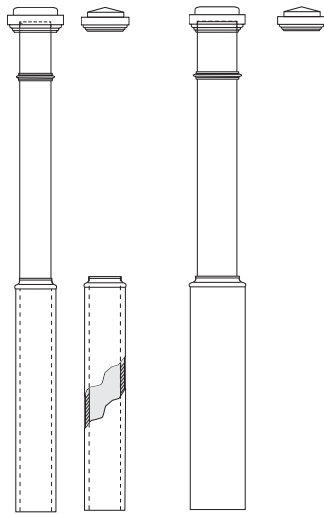

4090

Plain
3-1/2" Post
4-1/2" Base

4091

Plain
4-3/4" Post
6-1/4" Base

Full	\$333.15	\$497.27
Half	\$216.99	\$308.14

The 4090 series includes an adjustable base. Two caps included with the 4090 & 4091 series.

Primed **Skirtboards**

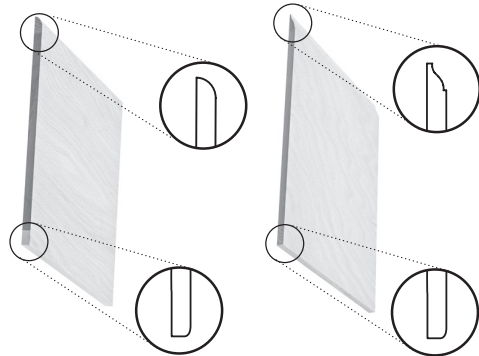

990/Eased Edge Skirtboard

7/16" x 9-1/4"
Veneered w/
finger-joint cap

991/Eased Edge Skirtboard

7/16" x 9-1/4"
Veneered w/
finger-joint cap

8'	\$70.59	\$70.59
10'	\$88.26	\$88.26
16'	\$141.18	\$141.18

Primed **Newel Parts**

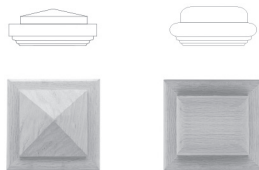

Pyramid & Square Replacement Cap Set

4090	\$57.81
4091	\$69.47

Set includes, collar, pyramid & square cap



	Block 30*	Block 2 TIER**
Each	\$84.48	\$34.05

*30" mounting block allows you to tie into structural framing used with 4091 & 4092 (an 8" block sent standard with all box newels).

**2 TIER mounting block allows you to tie into structural framing used with 4091 & 4093 (an 8" block sent standard with all box newels).

Primed **Rosettes**



7340 Square Rosette
4" x 4"

Each	\$13.82
-------------	---------

White Oak Rail

White Oak has distinct color variations, lighter and greyer tones than Red Oak, and can range from light colored through light to dark brown.

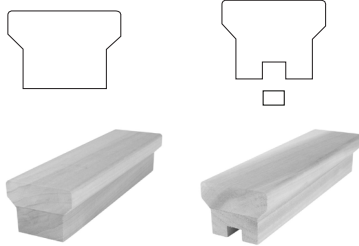

6500 Rail

2-1/4" x 1-5/8"

6500P2 Rail

2-1/4" x 1-5/8"
1/2" Plow
Includes 6207 fillet

6' pc	\$124.24	\$135.72
8' pc	\$135.29	\$150.35
10' pc	\$169.11	\$187.94
12' pc	\$248.48	\$271.44
14' pc	\$289.90	\$316.69
16' pc	\$331.31	\$361.93
18' pc	\$372.73	- - -

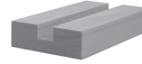

6003 Shoe Rail

2-3/8" x 3/4"
1/2" Plow
Includes 6207 fillet

6' pc	\$84.25
8' pc	\$81.96
10' pc	\$102.46
12' pc	\$168.50
14' pc	\$196.58
16' pc	\$224.66

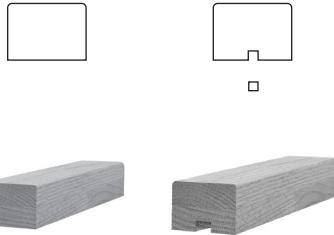

6770* Rail

2-1/4" x 1-9/16"

6770P2* Rail

2-1/4" x 1-9/16"
1/2" Plow
Includes 6207 fillet

6' pc	\$76.84	\$85.81
8' pc	\$102.46	\$114.40
10' pc	\$127.95	\$143.01
12' pc	\$153.68	\$171.61
14' pc	\$231.57	\$291.19
16' pc	\$264.66	\$332.79
18' pc	\$297.74	- - -



6107 Fillet

1-1/4" x 1/4"

6207 Fillet

1/2" x 3/8"

LF	\$3.80	\$1.91
----	--------	--------

**Handrails may not meet graspability codes. Please check local building codes before installing.*

White Oak Newels 3-1/2"

White Oak Box Newels 47-1/2"

59-1/2"

White Oak has distinct color variations, lighter and greyer tones than Red Oak, and can range from light colored through light to dark brown.



4001CH
56"

Full	\$353.62
Half	\$187.46



4095
Plain
5" Post



4096
Plain
5" Post

Full	\$502.22	\$549.89
Half	\$283.05	\$306.89

White Oak Newel Parts

Square cap only

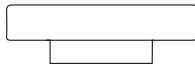

Square
Replacement Cap

4095/4096	\$152.57
------------------	----------

White Oak Treads & Risers

Each

White Oak has distinct color variations, lighter and greyer tones than Red Oak, and can range from light colored through light to dark brown.

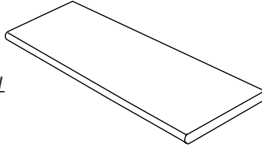

8070SE-48
Square Eased
Edge Tread

1-1/32" x 11-1/2"
x 48"

Each	\$152.08
------	----------

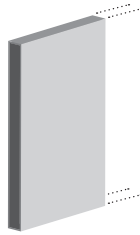

8075-48V
Veneered Riser

3/4" x 7-1/2" x 48"

\$30.09

White Oak Skirtboards

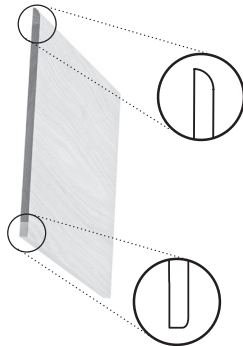

990/Eased
Edge
Skirtboard

7/16" x 9-1/4"
Veneered w/
finger-joint cap

8'	\$229.69
10'	\$337.95
16'	\$459.38
18'	\$594.30

White Oak Treads - Nosing/Cove



8590SE
Square Eased
Edge Landing
Tread

1-1/16" x 5-1/2"

Random LF	\$19.32
Specified LF	\$24.15

10' max length available



THIS PAGE INTENTIONALLY LEFT BLANK.

Hardware



STPK
Key Lock
6283

STPT
Thread Lock
6284

STPS
EZ Lock
6282

STPM
Mini-Lock
6287
2 per package

STPRB
Rail Bolt
6288
2 per package

STPBS
Baluster Screws
6281
24 per package

Each	\$23.65	\$25.58	\$24.53	\$12.61	\$11.91	\$10.34
-------------	---------	---------	---------	---------	---------	---------

Hardware



STPSD
Extra Driver
6289
(Drill attachment)

3011
Rail Bolt
Wrench

ZIPUT
ZipBolt UT

ZIPUTAR
ZipBolt Angled
Rail Bolt

ZIPHD5
ZipBolt Hex
Driver

Each	\$13.14	\$46.57	\$6.30	\$7.99	\$8.64
-------------	---------	---------	--------	--------	--------

Hardware

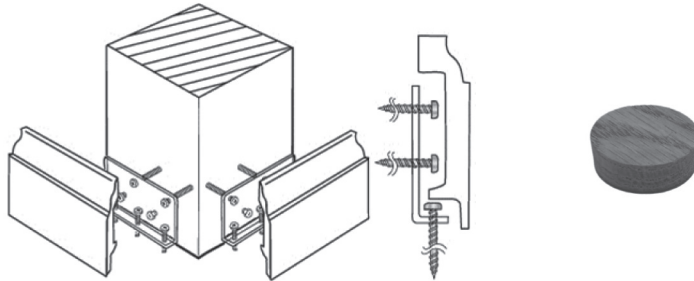

Use species code in the space of the SKU to specify wood type.

3007_
For 3" Newels

3008_
For 3-1/2" Newels

3000_
1" Flat Plug Face Grain

Oak (K)	\$57.46	\$57.46	\$1.21
Maple (M)	\$72.92	\$72.92	\$1.34
K. Alder (KA)	---	\$76.15	\$1.72
Poplar (PO)	\$66.28	\$66.28	\$1.41

Hardware

Use color code in the space of the SKU to specify finish type.



3002_
Wall Rail Bracket

3010_
Heavy Duty Wall Rail Bracket

3011_
Newel Mount Bracket

3015_
Adjustable Wall Rail Bracket

3004_
Modern Wall Rail Bracket

Black Satin (BS)	\$5.86	\$6.88	\$74.31	---	\$15.43
Matte Black (MB)	---	---	---	\$27.74	---
Silver (S)	---	---	---	\$27.74	---
Nickel (NI)	---	\$13.52	---	---	---
Oil Rubbed Copper (RC)	---	\$12.59	---	---	---
Polished Brass (PB)	---	\$13.73	---	---	---



FAMRCHBS
Cast Aluminum Chamfered Rosette

FAMRFLBS
Cast Aluminum Flat Rosette

FAMCCHBS
Cast Steel Chamfered Cap

FAMCFLBS
Cast Steel Flat Cap

FAMCSCBS
Cast Steel Stem Cap

Black Satin (BS)	\$21.73	\$16.67	\$25.45	\$17.43	\$34.72
------------------	---------	---------	---------	---------	---------