

407K/507K

HOLOSUN®

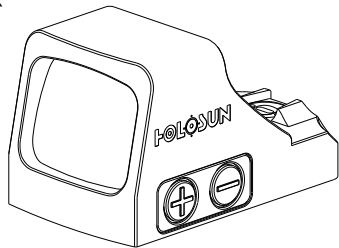

User's Manual

TABLE OF CONTENTS

Model	2
Important Notices.....	3
Objective Lens	5
Features	6
Multi-Reticle System.....	7
Battery.....	8
Product Installation.....	13
Sight Operation.....	15
Zero Setting.....	19
Configuration.....	22
Package Contents.....	23
Maintenance & Care	24
Limited Warranty.....	25

Thank you for purchasing the HOLOSUN 407K/507K series micro sights. The 407K/507K series are open reflex sights designed for handgun applications. Before operation, please read the User's Manual carefully.

Model

•
407K

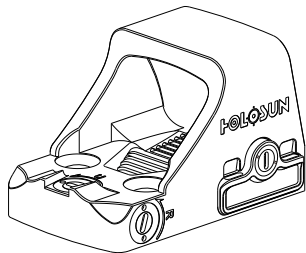

Fig1 407K/507K Series Reflex Sights

Important Notices

1. Ensure the firearm is unloaded and cleared by removing all ammunition and magazines from firearm and verifying an empty chamber before installation or battery replacement. **DO NOT ATTEMPT TO INSTALL THIS SIGHT KIT ON A LOADED FIREARM.**
2. Improper installation of firearm parts or accessories may result in death or serious personal injury. If you are not properly trained in the installation of these parts, have them installed by a gunsmith or armorer.
3. Please keep the packaging should you need to make a warranty claim.

! WARNING

- **INGESTION HAZARD:** This product contains a button cell or coin battery.
- **DEATH** or serious injury can occur if ingested.
- A swallowed button cell or coin battery can cause **Internal Chemical Burns** in as little as **2 hours**.
- **KEEP** new and used batteries **OUT OF REACH OF CHILDREN**.
- **Seek Immediate medical attention** if a battery is suspected to be swallowed or inserted inside any part of the body.



Objective Lens

All reflex sights have an objective (front) lens that is positioned off axis and appears to be tilted when looking at the sight. This angle of the objective lens allows the light generated by the LED inside the unit to be reflected creating the aiming point. The reflected light becomes the "dot" or aiming reference that the user sees. (See Fig 2)

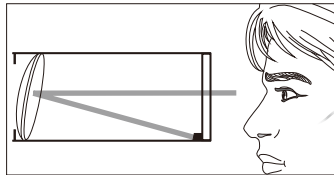

Fig 2

Features

1. Ultra compact size for concealed carry applications.
2. Reticle Options: Multi Reticle System(MRS) or 6 MOA Dot.
3. Shake Awake™ - Motion on with last setting recall.
4. Parallax free, unlimited eye relief.
5. CNC milled 7075 Aluminum Housing.
6. 10 day light and 2 night vision compatible brightness settings.
7. Window Size 0.58x0.77 inches.
8. IP67 Certified.

Multi-Reticle System

The reticle for 507K sight is a 2MOA dot centered in a 32MOA circle with four positioning points. (See Fig 3)

The diameter of the circle reticle represents approximately 32" at 100 yards(81cm at 100m). Hold the "-" button for 3 seconds to switch between the three reticles (Dot with Circle, Dot only, Circle only) in that order. (**507K model only**)

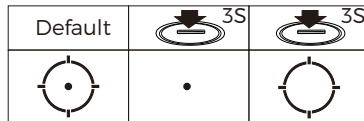

Fig 3

Battery

1. One high quality CR1632 Lithium battery is included with purchase.
2. A high quality battery can power this device for up to 50,000 hours at setting 6.
3. Battery replacement. (See Fig 3)
 - 1) Remove the battery:
 - i. Use the included T10 Torx tool to loosen the battery tray screw.
 - ii. Use the included tool as a lever in the battery tray slots to remove the battery tray and battery.
 - 2) Battery installation:
 - i. Insert the battery into the battery tray with the POSITIVE side facing DOWN.

- ii. Insert and press the tray into the battery compartment.
- iii. Tighten the battery tray screw to 5 in/lbs.

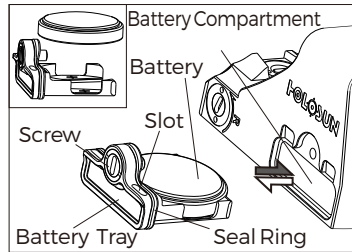

Fig 4

Caution:

1. Battery type (CR1632).
2. Battery chemistry (lithium).
3. Nominal voltage: (3V).
4. Remove and immediately recycle or dispose of used batteries according to local regulations and keep away from children. Do NOT dispose of batteries in household trash or incinerate.
5. Even used batteries may cause severe injury or death.
6. Call a local poison control center for treatment information.
7. Non-rechargeable batteries are not to be recharged.
8. Do not force discharge, recharge, disassemble, heat above (manufacturer's specified temperature rating) or incinerate.

Doing so may result in injury due to venting, leakage or explosion resulting in chemical burns.

9. Ensure the batteries are installed correctly according to polarity (+ and -).
10. Do not mix old and new batteries, different brands or types of batteries, such as alkaline, carbon-zinc, or rechargeable batteries.
11. Remove and immediately recycle or dispose of batteries from equipment not used for an extended period of time according to local regulations.
12. Always completely secure the battery compartment. If the battery compartment does not close securely, stop using the product, remove the batteries, and keep them away from children.

13. The loss or damage of the seal ring may cause water to leak into the battery compartment which could damage the product.

Note: The product include “Warning: contains coin battery” icon (See Fig 5), please don’t forcefully remove it.



Fig 5

Product Installation

NOTE: The sight is compatible with some standard mounting interfaces currently available. For a footprint drawing, contact Holosun.

1. Place the sight on a compatible slide cut or adapter plate. (this varies based on your slide configuration).
2. Use either the included screws or screws supplied with your slide or from your gunsmith and tighten to 15 in/lbs using a non-permanent (medium/blue) thread locker. (See Fig 6)
3. Verify proper clearances and firearm function prior to use.

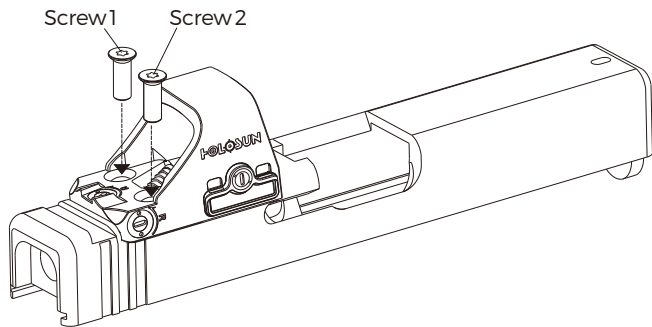

Fig 6

Sight Operation

- 1. Power ON:** Momentarily press either brightness button ("+" or "-") to turn on the sight. (See Fig 7)
- 2. Power OFF:** Press the "+" and "-" buttons simultaneously to power the sight and motion sensor off (this also turns off Shake Awake).
- 3. Operation Mode:** Two modes are available in the following order: Manual Mode -> Lockout Mode.
 - 1) Manual Mode:**

Brightness adjustment: There are 12 reticle brightness setting levels in manual mode. Settings 1 and 2 are NV compatible and setting 12 is the brightest. Press "+" or "-" to increase or decrease the brightness.

2) Lockout Mode:

Lockout mode activation: Hold the "+" button for 3 seconds (until the LED blinks once) to activate lockout mode. In lockout mode buttons are locked out preventing any setting changes. To deactivate the lockout mode, hold the "+" button for 3 seconds, the LED will blink once to confirm lockout mode is deactivated.

4. Sleep Time Setting:

- 1) Please note that your reticle will automatically enter into sleep mode after 10 minutes of no movement.
- 2) The sight will instantaneously wake up and turn on with any motion detection to last saved settings.
- 3) The default sleep timer setting is 10 min, but can be adjusted.

- i. Press and hold the "+" button for 10 seconds to enter sleep time adjustment mode. There are 4 options: 10 min, 1h, 12h or the sleep mode is disabled.
- ii. Press and release either "+" or "-" button to select a sleep timer setting. The LED will blink to show which setting is selected: 1=10 min, 2=1h, 3=12h, or 4=disable sleep mode (Shake Awake is disable).
- iii. Press the "+" and "-" buttons simultaneously to save the sleep timer setting and power off the sight.

5. Note:

- 1) Memory function: The sight will remember the last saved brightness setting when powered on and off.

- 2) Low battery warning: If the battery voltage is below 2.2Vdc, the reticle will blink slowly. (The warning voltage of HE407K-GR/HE407K-GD/HE507K-GR is 2.3Vdc)

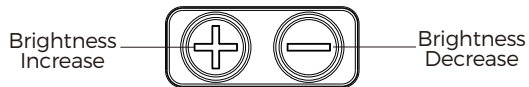

Fig 7

Zero Setting

1. This sight has been factory adjusted to an approximate 25 yard zero and should require minimal adjustment to achieve zero.
2. The Elevation adjustment is located on top of the tail section of the housing and the Windage adjustment is located on the right side of the housing. Adjustment can be performed by inserting the flat-tipped end of the included tool into the turret slot and rotating. (See Fig 8)
3. Windage and Elevation adjustments are approximately 1 MOA per click.
4. Each adjustment click has a value of approximately 1 MOA or 1 inch at 100 yards (1/2" at 50y; 1/4" at 25y). When zeroing at 25 yard, if your impacts are 2 inches low and 1 inch right, you will need to adjust Elevation 8 clicks UP (counterclockwise) and 4

clicks LEFT (clockwise).

5. The maximum adjustment range is ± 30 MOA from center.

Caution: If you feel the windage or elevation adjustments can no longer be rotated, you may have reached the mechanical limit of the adjustment turret. Do not try to rotate the knobs further if you feel a bind or you may cause damage. If you exceed the adjustment range, please contact your gunsmith or Holosun for assistance.

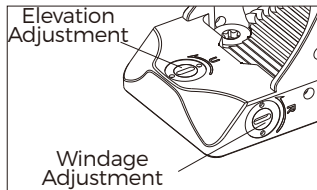

Fig8

Included Tool:

1. Flat tipped end is used to adjust the Windage & Elevation.
2. T10 Torx tool for screws (see Fig 9).

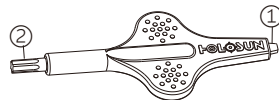

Fig 9

Configuration

CONFIGURATION	Reticle	LED Color	Housing Color
HS407K	6 MOA Dot	Red	Black/ Flat Dark Earth
HE407K-GR	6 MOA Dot	Green	Black/ Flat Dark Earth
HE407K-GD	6 MOA Dot	Gold	Black
HS507K	2MOA Dot & 32MOA Circle	Red	Black/ Flat Dark Earth
HS507K-GR	2MOA Dot & 32MOA Circle	Green	Black

Package Contents

The package should contain the following items:

1. Open pistol sight
2. HOLOSUN card
3. 2*M3-9.8 screws
4. 2*M4-9.8 screws
5. 2*6-32×12 screws
6. User manual
7. Cleaning cloth
8. Desiccant
9. T10 Torx tool

Maintenance & Care

This device is a precision instrument that deserves reasonably cautious care. The following tips are provided to ensure a long product life. The optical lenses are multicoated optical glass. When cleaning the lenses, blow away the dust on the surface, wet the lens with lens cleaner or clean water, then wipe away smudges with lens tissue, soft cotton or a microfiber cloth. Avoid touching the glass surface with dry cloth or tissue paper. Do not use organic solvents such as alcohol or acetone. No special maintenance is needed for the housing surface. Do not try to dismantle the device as the internal parts are specially cleaned and sealed and with an anti-fog treatment. Any such attempt will void the warranty.

Limited Warranty

We provide a limited lifetime warranty from the date of purchase on parts and workmanship to the original purchaser. At our sole discretion, we will repair or replace products found to be defective under normal use without charge, excluding any delivery costs, which will be born by purchaser. We will not be liable for incidental, consequential, or special damages arising out of or in any connection with the use or performance of this product. This warranty is void if the product has been misused, modified, neglected, or disassembled prior to its return. Please refer to www.holosun.com for current and complete warranty information and other conditions.

For more information about Holosun, our Terms of Use and Sale, and our Privacy Policy, please visit holosun.com.



Holosun Technologies Inc.

Phone: 909-594-2888

Email: info@holosun.com



WARNING :Cancer and
Reproductive Harm -
www.P65Warnings.ca.gov

1208001638 A1