



Lumana LUM252 / LUM254

Core



Hybrid-cloud video security system with simple deployment and real-time edge processing

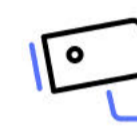

Optimizes existing camera infrastructure and brings visual intelligence to any workspace or environment

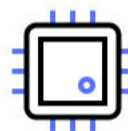

Best-in-class, self-learning AI algorithms tailored to your unique environment



Secure by default with enterprise-grade encryption and cybersecurity protocols

Lumana hybrid-cloud architecture

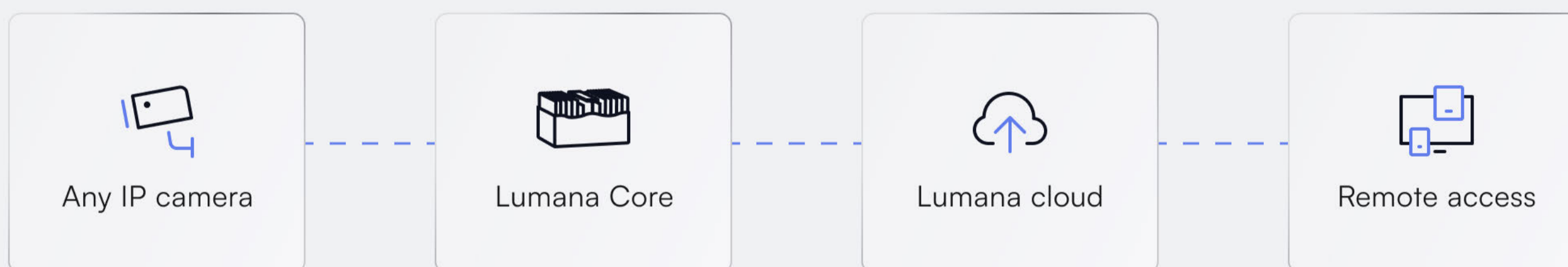

Camera agnostic

Open platform provides powerful AI analytics to any security camera for greater situational awareness and operational efficiency.

Actionable intelligence

Self-learning AI adapts to your environment to predict anomalies and trigger automatic alerts for more proactive response.

Infinitely scalable

Manage unlimited cameras and users from one platform and utilize AI to empower your team to do more with fewer resources.

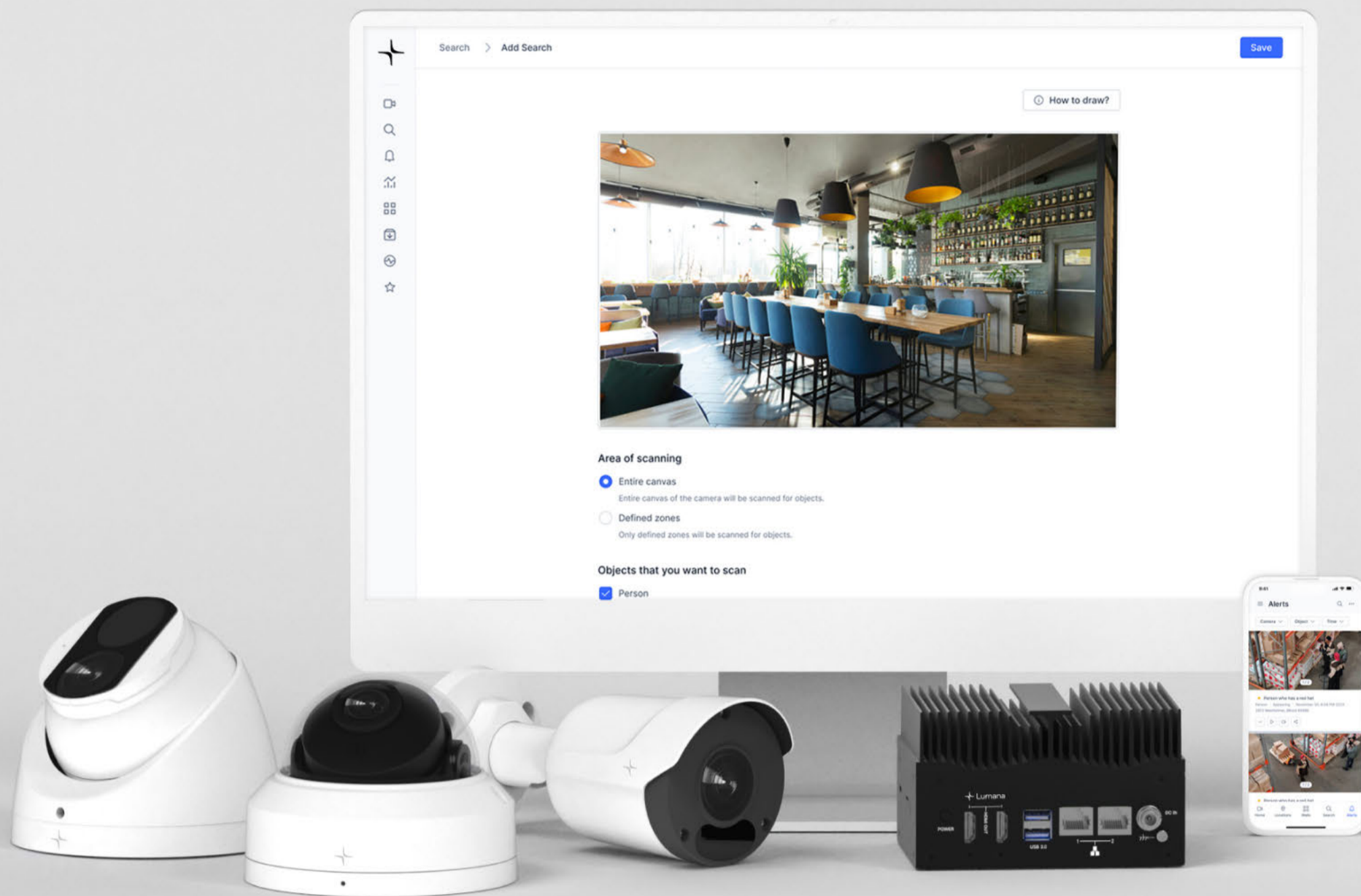

Modern system management

Designed for easy deployment and enhanced reliability, Lumana delivers the best from on-premise and cloud solutions for a modern and refined security experience.

- Centralized management and secure remote access
- Plug-and-play setup — integrate visual AI in minutes
- Automatic updates and system health monitoring

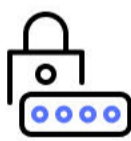

Secure by default architecture

From camera endpoint to application security, Lumana features enterprise cybersecurity protocols to provide powerful AI video security built with data privacy in mind.

- End-to-end encryption for data at rest and in transit
 - No port forwarding or inbound network traffic
- Automatic security updates and routine pen tests



Next-generation AI features

Patented AI and machine learning algorithms empower your team to operate more efficiently by delivering unparalleled visibility and new business insights at scale.

- Receive real-time alerts for immediate response
- Find people or vehicles of interest in seconds
- New AI features and system upgrades at no cost

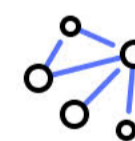

Built for enterprise deployments

Whether you have 50 or 500 cameras, Lumana simplifies security with modern video management and proactive AI to help you focus on what matters most.

- Easy-to-use software accessible from web or mobile app
- Real-time AI to help users operate 10x more efficiently
- Distributed architecture for better performance and cost

Lumana LUM252 / LUM254

Core

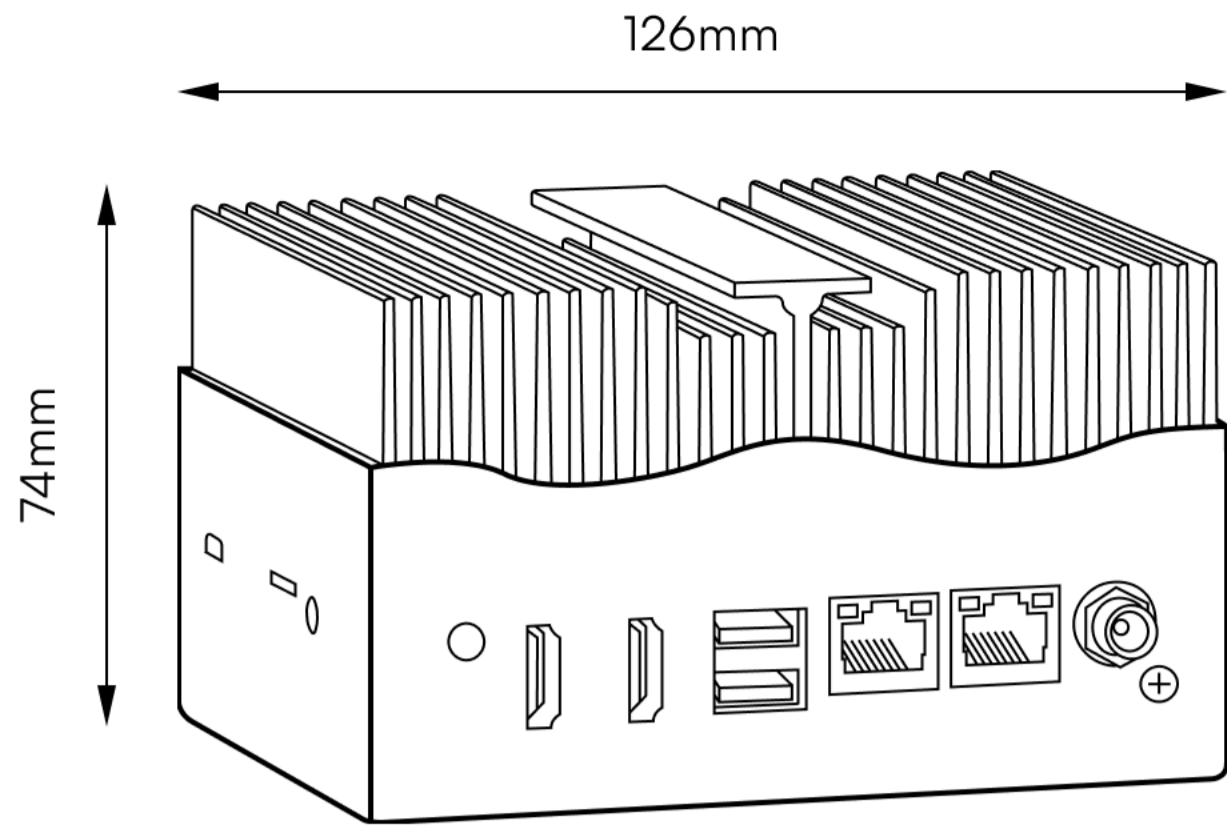

System

Software	Lumana VMS+	Offline operation	Full operation and recording
Compression	H.265, H.264	Automatic updates	Yes
Bandwidth	Steady-state: 100 Kbps/camera	Input power	100v/240v (50-60Hz)
Networking	2x GbE RJ-45	Expansion header	GPIO, I2C, UART
Supported resolutions	Up to 12MP (4000x3000)	Storage	Industrial-grade SSD
AI processing	Real-time	Storage capability	Up to 90 days local Up to 365 days in cloud

Mechanical

Dimensions (H×W×L)	74 × 126 × 96mm (2.9" × 5.0" × 3.8")	Weight	1.1kg (2.42 lbs)
---------------------------	---	---------------	------------------

Environmental

Operating temperature	-25°C ~ 60°C (-13°F ~ 140°F)	Humidity	40°C @ ≤95% RH (non-condensing)
------------------------------	------------------------------	-----------------	------------------------------------

Ownership

Warranty	Lifetime*	Support	24/7 U.S. based support
-----------------	-----------	----------------	-------------------------

*Must remain a customer to qualify for lifetime warranty